



Secondary Packaging

Supply Chain Standards

August 10, 2023

Secondary Packaging Supply Chain Standards - Update Summary

These standards have included multiple clarifications of what is **required** and what is **NOT ALLOWED**. These changes have been updated throughout the published standards to provide clarity to Suppliers. The pages have been reorganized to provide a better flow.

PAGE	2023 UPDATES
Changes to Supply Chain Standards	
181	Updated Contact Information
186	Updated PO Accuracy Defect Chart
188-191	Updated FixIt Sub-Defect Names
195-202	Clarification of required ISTA test protocols
205	Add Refrigerated/Frozen Case Size Requirements
208	Add “Carton Lids” requirement for clarity
210	Add Shrink Pack Tray Window/Cutout requirements
216	Update verbiage in GTIN use section for clarity
225	Add contact info for Lithium Battery Markings where carton is too small for compliance
233	Update Unbranded Pallet Standard wording and illustration for clarity
235	Clarify Slip Sheet Material Requirement
242	Add Palletized Consistency requirements
252	Remove ASN Support information that is no longer valid
256	Add Glass/Ceramic Shrink Pack requirements to Fragile Product Packaging Section for improved clarity and guidance
258-259	Update Shoe Packaging and Labeling requirements
263	Update the scope of RFID hardline packaging requirements – includes 8 new departments added
265	Update RFID Packaging Sticker Required Fields
280	Update DSDC Support information
287	Update DSDC Support information
317	Add Sealed Packaging Requirement for all Fresh Seafood Shipments
337	RFID/Set Week Labels for Apparel Items removed as requirement, Apparel Suppliers to use Standard New Mod Labels

Table of Contents

Supply Chain Standards

Secondary Packaging Supply Chain Standards - Update Summary	177	Case Shipping Label - Domestic	226
Table of Contents	178	Pallet Shipping Labels - Domestic	227
Contact Information	181	Pallet Shipping Labels –Pallet Pull / PDQ	228
Walmart Retail Link Resources	182	Pallet Placards	229
Walmart Distribution Center Overview.	183	Item and PO Configurations	230
Walmart eCommerce Network (Walmart.com)	184	Pallet Standards	231
Supplier Quality Excellence Program (SQEP)	186	Slip Sheet Requirements	235
SQEP Supporting Standards	188	Tier Sheet Requirements	236
Corrugated Board Specifications.	192	Double Stacking - Inbound to Walmart	237
Required Package Testing	195	Double Stacking - Outbound from Walmart	238
Package Testing Requirements for: Walmart Private and Exclusive Brands.	197	Unitized Stacking.	239
Case Quality	203	Unitized Shipments	241
Receiving Quality	204	PDQ Display – General Pack-Out	243
Automation Eligible Cases	205	PDQ Display – Approved Shipping Shroud Types.	244
Automation Ineligible Cases	206	PDQ Display – Shipping Options.	245
Case Quality	207	Stretch Wrap	246
Case Quality, Shrink Wrap Items	209	Trailer Loading	247
Pack Types	211	Trailer Measurements	248
Case Pack vs. Break Pack	213	Trailer Load Patterns.	249
Automation Eligible Inner Packs and Plastic Bags.	214	Packing Slips and Global Location Number (GLN)	250
ITF-14 Orderable GTIN Barcode	218	Bill of Lading (BOL)	251
GS1-128 Barcode	219	Advanced Ship Notice (ASN)	252
General Case Markings	221	Inbound Appointment Scheduling	253
Inner Pack Case Markings	222	Product Packaging	254
Shrink Pack Tray Case Markings	223	Fragile Product Packaging	255
Case Weight and Hazmat Case Markings	224	Apparel Packaging	257
Lithium Battery Case Markings	225	Shoe Packaging and Labeling	258
		Shoe Packaging and Labeling - Inner Pack	259

Table of Contents

RFID Apparel Packaging, Introduction / Packaging Type	260	Jewelry Distribution - Overview	305
RFID Hardline Packaging	263	Optical Distribution Centers	306
RFID Packaging, Hangtags.	264	Pharmacy Distribution Centers, Overview and Inner Packs	309
RFID Packaging, Stickers	265	Pharmacy Distribution Centers, Case Labels and Markings	310
Direct Store Delivery - ASN Shipping Label Requirements	267	Pharmacy Distribution Centers, Shipping Label and Packing List.	311
Direct Store Delivery - Multi-Dept. Deliveries	268	Goods Not For Resale (GNFR)	312
Direct Store Delivery - Case Markings	269	Cold Chain Compliance Requirements	313
Sellable Unit Marking Requirements.	270	Egg Packaging and Case Labels	314
Ships In Own Container (SIOC)	271	Egg Pallet Build Requirements	315
eCommerce Product-Specific Requirements.	272	Meat/Poultry Items	316
Drop Ship Vendors	273	Seafood Items.	317
Drop Ship Vendors - Carrier Labels	274	Meat/Poultry/Seafood Case and Pallet Labels.	318
Drop Ship Vendors - Freight Shipping Labels	275	Produce Case Label - Produce Traceability Initiative (PTI)	319
Drop Ship Vendors - Bill of Lading (BOL)	276	Produce Pallet Label - PTI	320
Walmart Fulfillment Services (WFS)	277	Produce Shipments	321
Walmart Fulfillment Services (WFS) Master Packs	279	Bakery/Deli Wraparound Label	322
DSDC Supplier Requirements.	280	Bakery/Deli Wraparound Label Application	323
DSDC Shipping Label Specifications	284	Perishable Labeling Requirements	324
Consolidation Centers	288	Floral Consolidation Centers (FCC)	325
Consolidation Centers, BOL, Multi-Stop and Overflow.	289	Floral Pallet Label	327
Consolidation Centers, Loading Procedures	290	Grocery Import Distribution Center (GIDC)	328
Consolidation Center Case Shipping Label.	291	Grocery Import Distribution Center (GIDC)	329
Consolidation Center Pallet Shipping Labels	292	Grocery Consolidation Centers (GCC)	330
Pallet Shipping Labels – Pallet Pull / PDQ	293	Focus Points for Successful Delivery and Flow of Product.	331
Consolidation Centers, Multiple POs per Pallet (MPP)	294	Inbound Scheduling	332
Consolidation Centers, MPP Same Destination Pallet	295	Notification Requirements from Suppliers.	333
Consolidation Center, Order Unitization	296	Grocery Consolidation Center Pallet Placards	334
Walmart USA and Puerto Rico Case Markings.	297	Same PO Multiple Items	335

Table of Contents

General Merchandise

New Modular Labels (Excluding D56)	337
D56 New Modular Labels (Lawn & Garden)	338
Store Case Markings.	339
Markings Artwork Usage, Examples	340
Feature Case Markings	341
Seasonal Department Band Colors	342
Holiday Time Brand, Band Colors, and Icons	343
Seasonal Department, Band Colors, and Icons	344
Department Band Colors and Icons	345
Department Band Colors and Icons	346
Department Band Colors and Icons	347
Department Band Colors and Icons	348
Department Band Colors and Icons	349
Department Band Colors and Icons	350
Back to School, Format and Icon	351
Department Band Colors and Icons - Food	352
Deli Case Formatting - Color Band	353
Bakery Case Formatting - Color Band	354
Cake Case/Freezer Door Formatting - Color Band	355
Bakery/Deli Case Formatting - Hierarchy	356
Bakery/Deli Holiday Icon Labels	357
Frozen Seafood Case Formatting - Hierarchy.	358
Frozen Seafood Case Formatting - Hierarchy.	359

Appendices

Appendix A: FedEx Labeling and PO Compliance	361
Appendix A: FedEx FAQ	362
Appendix B: UPS Labeling and PO Compliance	363
Appendix C: ISTA Testing	364
Appendix D: Temperature Standards	367
Appendix E: Previous Updates	376
Appendix F: Walmart USA and Puerto Rico Case Labels	382

FAQs and Glossary

General FAQs.	385
Plastic Bag Safety Labeling FAQs.	386
Glossary	387

Contact Information

Walmart Supply Chain

Accounts Payable - Stores
479-273-4089

Accounts Payable - eCommerce
888-499-6377

ASN Requirements
479-273-8888

Carrier Relations
479-273-6554

EDI Help Desk
479-273-8888

Hazardous Materials Transportation
hazmat@wal-mart.com

General Supplier Information
Walmart Buyer

Item File Compliance (WERCS Support)
wmuscoitem@walmart.com

Walmart Retail Link Help Desk
479-273-8888

DSDC
dsdcsup@wal-mart.com

Walmart Transportation
<https://wal-marttransportation.na1.teamsupport.com>

Walmart Collect Transportation
Sams Club: 479-360-4169
Consolidation: 479-360-3203
Truckload Direct and Supplier Education: 479-371-0661

Traffic Analyst
479-277-9560

GS1 (Global Barcode Standards)
www.gs1us.org

GS1 Bill of Lading Guidelines
www.gs1us.org/industries/apparel-general-merchandise/workgroups/logistics

Direct Ship Vendor (DSV) Support
<https://Supplierhelp.walmart.com/s/>

Healthcare Distribution Alliance (HDA Guidelines for barcoding pharmaceutical)
www.hda.org/resources/hda-guidelines-for-bar-coding-in-the-pharmaceutical-supply-chain

FDA DSCSA (Drug Supply Chain Security Act)
www.fda.gov/drugs/drug-supply-chain-integrity/drug-supply-chain-security-act-dscsa

IATA and DOT – Pipeline and Hazardous Materials

Safety Administration PHMSA eCFR website:
www.ecfr.gov/cgi-bin

Walmart Stores Packaging and Labeling
WMBarcodeLabeling@walmart.com

Walmart Stores Inbound Quality Managers

SQEP Contact Information Updates
sqep_email@walmart.com

Package Testing
ISTATesting@wal-mart.com

Walmart.com

DSV questions | Orange S2S Labels
<https://Supplierhelp.walmart.com/s/contact>

Returns Drivers
RETURNSM23@walmart.com

Walmart.com Labeling
labeling@walmart.com

Vendor Compliance Charge-backs
vcompliance@walmart.com or
<https://portal.teamsupport.com/GECTransportation>

Package Testing
ISTATesting@wal-mart.com

Walmart Canada Inbound Compliance

Walmart Canada Packaging and Labeling
CAIBC@email.wal-mart.com

Avery Dennison

Diane McConnell: Miamisburg, Ohio, USA
Diane.mcconnell@averydennison.com
937-865-2957

Mónica Rodríguez: Santa Rosa Jauregui, Qro México
monica.rodriguez@averydennison.com
442-229-5600 ext. 647

Shelly Yi: Suzhou, Jiangsu Providence, China
shelly.yi@ap.averydennison.com
+86-512-62628974

Palin Jiang: Nansha, Guangzhou, China
palin.jiang@ap.averydennison.com
+86-20-3930-6303

Wendy Chen: Fuzhou, Fujian Province, China
wendy.chen@ap.averydennison.com
+86-591-8397-7928

Nicole Zhang: Qingdao, Shandong Province, China
nicole.zhang@ap.averydennison.com
+86-532-8610-560

Walmart Retail Link Resources

Purpose of this Manual

This manual provides general case quality and case marking requirements for shipping domestic freight into Walmart Distribution Centers. While every effort has been made to provide a clear understanding of our shipping requirements, no single resource is capable of identifying every possible scenario. Use the following resources (found on Walmart Retail Link) to identify other requirements for specific product or technical information not addressed in this manual.

Walmart Secondary Packaging Standards

<https://supplieracademy.wal-mart.com/mod/wiki/view.php?id=75>

Transit Testing

<https://supplieracademy.wal-mart.com/mod/wiki/view.php?id=222>

DSD (Direct Store Delivery)

<https://supplieracademy.wal-mart.com/course/view.php?id=2017>

DSDC

<https://supplieracademy.wal-mart.com/mod/wiki/view.php?id=952>

EDI/ASN

<https://rl2.wal-mart.com/edi/home/>

Perishable (ZZZZ) ASN

[Retail Link](#) > [Apps](#) > [Filter Docs "ED"](#) > [EDI-B2B](#) > [Guides](#) > [Perishable ASN](#)

Fine Jewelry Quality Testing Manual

[Retail Link](#) > [Apps](#) > [Product Quality and Compliance](#) > [a5 Apparel Accessories Footwear Jewelry: Manuals and Tools](#) > [Performance Testing](#) > [Jewelry – Walmart USA Fine Jewelry Quality Testing Manual](#)

Fine Jewelry Product Development Manual

[Retail Link](#) > [Apps](#) > [Product Quality and Compliance](#) > [a5 Apparel Accessories Footwear Jewelry: Manuals and Tools](#) > [Technical Design](#) > [WM Fine Jewelry Product Development Manual](#)

Primary Packaging Tool Kits

https://rl2.wal-mart.com/marketing/packaging_toolkit.aspx?ukey=w5263

Sam's Club Packaging

https://rl2.wal-mart.com/rl_posting/view_review.aspx?docid=1889&ukey=W3819

Shipping and Routing

<https://supplieracademy.wal-mart.com/mod/wiki/view.php?id=55>

Supplier Quality Excellence Program (SQEP)

<https://supplieracademy.wal-mart.com/mod/wiki/view.php?id=1448>

UPC Requirements

<https://supplieracademy.wal-mart.com/mod/wiki/view.php?id=66>

US Product Safety and Compliance

<https://supplieracademy.wal-mart.com/mod/wiki/view.php?id=42>

Walmart Distribution Center Overview

The following pages include information and specifications for Suppliers shipping domestic merchandise through the Walmart Distribution Network. It is the responsibility of the Supplier to follow these requirements to help ensure that all packaging can sustain the distribution environment from the manufacturer all the way to the store shelf.

Walmart Ambient Network

The Walmart ambient distribution network includes the shipment of all items into distribution or fulfillment centers that do not require temperature control.

Regional Distribution Centers (RDCs)

RDCs process freight in full pallet quantity, individual case quantity, and break pack quantity.

- Freight is designated as Staple Stock (held in DC inventory) or Distribution (flow through inventory).
- RDCs take advantage of automation, high speed conveyors, and sorting equipment to move freight from the inbound receiving dock to a specific outbound store trailer quickly and efficiently. This network is designed to ship individual cases via automation from multiple induction points through a central merge station and onto the shipping trailer. Some RDCs utilize a higher level of automation, including robotic handling technology.

Walmart has two basic types of RDCs.

- Batch-processing centers where stores are grouped into batches for shipping.
- Door-per-store centers where a shipping door for each store is designated.

Import Distribution Centers (IDCs)

The IDCs process mainly floor loaded general merchandise freight received in ocean containers.

- Product may be unloaded from the container using clamp equipment. It is critical that the product is packaged properly to withstand multiple instances of clamping between unloading and shipping.

- After receiving the freight, cases are placed on pallets while in storage.
- Cases are cross-docked through the RDCs for shipment to the stores.
- To maximize shipments to the RDCs, cases are removed from the storage pallet and floor loaded to the RDCs.

Fashion Distribution Centers (FDCs)

FDCs combine the latest technology with proven processes to ship both full cases and individual SKUs to the store network via cross-dock through RDCs.

Direct Store Delivery Consolidation (DSDC)

A program developed to provide an efficient channel to replenish stores in less-than-case-pack quantities.

Consolidation Network - The Walmart consolidation network allows Suppliers to ship items for multiple locations to 1 central location for distribution throughout the network. This helps lower transportation costs to empower EDLC and EDLP. There are 3 types of GM consolidation centers.

- **ACC (Automated Consolidation Center)** - The Walmart ACC uses advanced automation equipment to help move product to the correct distribution centers. The ACC is a high-speed facility designed to process full truckload quantity national orders. These orders are sorted and distributed to the correct Walmart DC.
- **MCC (Manual Consolidation Center)** - The Walmart MCC is a high-speed facility that manually sorts and distributes full truckload quantity national orders to the correct Walmart DC.

- **GMC (Traditional General Merchandise Consolidation)** - The Walmart GMC facilities sort small orders from multiple vendors to be distributed in full truckload quantities to the RDC network.

Jewelry - The Walmart Jewelry network is designed to efficiently flow small items with high value safely and efficiently from the Supplier to Walmart US Stores.

RX - The Walmart Prescription Drug network is a highly regulated supply chain that manages the receipt and distribution of all prescription drugs to Walmart US Stores.

Optical - The Walmart Optical network services the entire country to distribute prescription eyewear to Walmart US Vision Centers, Sam's Vision Centers, Walmart Optical Labs (including locations in Mexico), and other global locations.

Direct Store Delivery (DSD)

DSD is a method of shipment that allows Suppliers to bypass traditional Walmart Distribution Centers and deliver product directly to stores.



Walmart Distribution Center Overview

Walmart eCommerce Network (Walmart.com)

Walmart.com uses fulfillment centers to distribute product directly to consumers through sortable and non-sortable fulfillment centers, Walmart Fulfillment Services, and drop shipping direct to the consumer (DSV).

Sortable FCs | Automation Eligible

Sortable FCs process freight at individual case quantities and break pack quantities. The shipping cases accepted here are those that are eligible for automation. These facilities are referred to as “Sortable” FCs.

Automation eligible cases and packaging can be subjected to heavy compression on the rollers and belts as well as vibration, abrasion, temperature, and humidity changes during normal FC handling and processing. Automation eligible cases and packaging must be able to withstand industry standard testing. Cases must stay intact and protect the merchandise within the case.

The preferred shipping method into Sortable FCs is palletized. Approval for floor load or slip sheet (excluding parcel shipments) must be obtained through the Walmart Inbound Quality Senior Manager at logpkg@wal-mart.com

Non-Sort FCs | Automation Ineligible

Certain items may not be automation eligible due to large size or unusual dimensions. For example, bicycles, outdoor furniture, lawnmowers, large TVs, tires, garden tools, and long rugs. These items exceed the maximum dimensions and weight for automation and are acceptable Non-Sort items. Such items will reside in our “Non-Sort” facilities or “Non-Con” FCs.

e-DCs

Walmart.com will also leverage existing network capabilities and may utilize FCs co-located within our RDC (Regional Distribution Center) facilities that also support Walmart Stores. The Walmart.com e-DCs are capable of supporting both sortable and non-sortable items.

WFS (Walmart Fulfillment Services)

Walmart Fulfillment Services (WFS) provides customers with best-in-class fulfillment services, leveraging Walmart's supply chain scale and world-class operations. WFS enables sellers to lower fulfillment costs, improve conversion rates, and price items more competitively, improving sales and ROI. Adherence to Walmart WFS standards solidifies the Walmart/Supplier partnership, contributing to the future success of both.

DSV (Drop Ship Vendors)

The Walmart DSV program allows external vendors to receive product orders from the Walmart.com website. Upon receipt of the order, the item ships directly to customers or local stores as part of the S2S (Ship to Store) program.



Walmart Distribution Center Overview

Grocery Distribution Network

Grocery Distribution Centers (GDCs)

GDCs process palletized dry grocery and perishables (dairy, deli, frozen, meat, and produce).

- After receiving, pallets are stored in a reserve location until needed for order fulfillment.
- Completed store pallets are stretch-wrapped and loaded onto outbound trailers.

This network is considered a conventional warehouse distribution system. Automatic Storage and Retrieval System (ASRS) technology, conveyors, and automatic depalletization/palletization technology has been incorporated into some of the newest grocery DCs. These facilities may utilize a combination of pallet conveyance/lifting, case conveyance/lifting, layer clamping, case clamping, and automated palletizing to get freight through the facility.

Floral Consolidation Center (FCC)

The Walmart Floral Consolidation Center plays a key role in maintaining the shelf life of fresh cut flowers into our store network. All fresh cut flowers will first ship into the FCC before flowing to other temperature controlled distribution centers. This network has been designed to get fresh cut flowers into our stores quickly and efficiently to provide customers with the freshest flowers possible.

Grocery Import Distribution Centers (GIDCs)

The GIDCs process freight in a similar manner to the standard GDC network, but receive only imported grocery products. The nature of this distribution network presents unique requirements.

GCC (Grocery Consolidation Center)

The Walmart GCC consolidates full pallets of grocery items that require cold chain compliance and handling. Pallets are consolidated in temperature-controlled facilities and shipped on with other product to Walmart Grocery Distribution Centers.

Fresh Solutions Center (FSC)

The Walmart Fresh Solutions Centers (FSCs) are an important part of the cold chain environment for Walmart. The FSCs process fresh items that require cold chain compliance and handling. Fresh items are processed for further distribution into the Walmart Grocery Distribution Centers.



Supplier Quality Excellence Program (SQEP)

SQEP Introduction

To serve customers right the first time, Walmart US Supply Chain (omni-channel) has launched the Supplier Quality Excellence Program (SQEP). SQEP will obtain best-in-class status through defect elimination, value-added services, and a zero-based mindset. The purpose of this program is to evaluate, measure, and monitor Suppliers' inbound quality in order to:

- Exceed customer satisfaction.
- Improve end-to-end accuracy and visibility.
- Drive continuous improvement towards perfection.
- Implement First Time Quality (FTQ).
- Reduce operational costs.

SQEP will be applicable to all Walmart U.S. distribution networks, including eCommerce Fulfillment Centers. SQEP is going to establish end-to-end quality by pursuing Supplier compliance.

Excellence will be achieved in the receiving process by focusing on the four rights:

- Right Item
- Right Condition
- Right Invoice
- Right Time

Through SQEP, Suppliers will be **required** to strictly comply to Walmart Standards and drive continual improvement against identified opportunities. The Suppliers may be **required** to offset any additional costs against non-compliance to Walmart U.S. Supply Chain Standards for Inbound Receiving (a.k.a. Packaging Guidelines).

Important Dates

Supplier Quality Excellence Program will be rolling out as per below schedule:

PHASE 1b	PO Accuracy	Q1 - FY22
PHASE 1c	ASN	Q2 - FY22
PHASE 2	Barcodes and Labeling	Q3 - FY22
PHASE 3	Pallet, Load, Packaging Quality, and Prep (eCom)	Q4 - FY22
PHASE 4	Scheduling and Transportation	TBD

NOTE - Details on additional phases will be published in future standards updates. For more information, visit https://wmgbs-support.custhelp.com/app/retail_link.

Phase 2 barcode and labeling must comply with all barcode and labeling standards contained within this set of standards.

Walmart U.S. Supply Chain Standards for Inbound Receiving

PHASE 1 - PO Accuracy

Defect Description	Defect Definition
Overage	PO line shipped exceeds quantity ordered.
Canceled PO	Supplier ships against a PO after it has been canceled.
Canceled Line	Supplier ships against a line item after it has been canceled.
Item Not on PO	Item shipped does not match item on PO.
Wrong Pack	Vendor pack quantity shipped does not match vendor pack quantity on PO.
Recall/Withdrawal	Item has been recalled, removed, etc.
Date Issue	Item violates the outlined date requirements.
Not Walmart Freight	Supplier shipped non-Walmart freight.
No ASN Label	DSDC Only - No ASN (SSCC) label on case.
ASN Not Downloaded	ASN failed to download.
Rework	Item is relabeled, poly bagged, boxed, taped, or other rework incurred at the DC.
Allocation issue	Sort vs. non-sort or assigned to incorrect Store.
Imagery	Dotcom only - Incorrect or incomplete item depiction on portal.
Item Setup	Missing, incomplete, or inaccurate setup information that prevents timely receipt.
Parent-Child	Child UPC not linked or incorrectly linked to Parent UPC.

Supplier Quality Excellence Program (SQEP), cont...

Phase 2 - Barcode and Labeling

Suppliers must comply with all published barcode and labeling standards within this document. The defect descriptions and definitions below provide general guidance on how defects are calculated, and these defects will be measured against the standards published within this document.

Phase	Defect Description	Defect Definition
2	Barcode Compliance	Wrong format, incorrect quantity, incorrect barcode, or other barcode defects
2	Label Compliance	Incorrect quantity, missing/incorrect description, item #, or supplier stock #, or other labeling defects
2	Hazmat Compliance	Hazmat label missing/covered

Phase 3 - Packaging, Pallet Compliance, and Load Quality

Suppliers must comply with all published Packaging, Pallet, and Load Quality standards within this document. The defect descriptions and definitions below provide general guidance on how defects are calculated, and these defects will be measured against the standards published within this document.

Phase	Defect Description	Defect Definition
3	Packaging Compliance	Weak packaging/glue/tape, poor perforations, missing tray/lid, loose wrap, undersized/oversized case, selling units not secured, or other packaging defects
3	Pallet Labeling	Missing shipping label or other pallet labeling defects
3	Pallet Securement	Poor securement, bagged item, missing tray, or other pallet securement defects
3	Pallet Build	Pallet overhang, excessive height, or other pallet build defects
3	Pallet Quality	Non-compliant with Grade A standards, non-compliant size, or other pallet quality defects
3	Load Stability	Shifted, unstable, not palletized, or other load stability defects
3	Load Segregation	Segregation by PO type PO, item or other load segregation defects

SQEP Supporting Standards

FixIt Defect	FixIt Sub-Defect	Description	Supporting Standard Location
Barcode Compliance	Wrong Format	Inspection and Automation: Barcodes are present on the case, but there are no barcodes with the required format.	General Merchandise: Page 221-223
	Barcode Not On Two Sides (Incorrect Quantity)	Inspection and Automation: Barcode is only on one side of the case.	Produce: Page 319-320
	No Barcode Found (Missing Barcode)	Inspection: No barcodes present on the case. Automation: No barcodes are present on the case. The sub defect will not reflect "Missing." The case will fail Wrong Format and Incorrect Barcode.	Meat/Seafood/Poultry: Page 316-318 Eggs: Page 314-315
	VNPK GTIN Does Not Match Item Setup (Incorrect Barcode)	Inspection: Barcodes are present, but none match OLIF or Item 360. Automation: The correct format for the item configuration does not match OLIF or Item 360. If Wrong Format is identified, Incorrect Barcode will also be identified.	DSDC: Page 280-287 Direct Import: Page 297-304
General Case Marking Compliance (Label Compliance)	Carton Marking Not On Two Sides (Incorrect Quantity)	Carton markings are only on one side.	General Merchandise: Page 221-223 Produce: Page 319-320
	Item Description Not Found (Missing Description)	No item description printed on the case.	Meat/Seafood/Poultry: Page 316-318 Eggs: Page 314-315 DSDC: Page 280-287
	Missing Required Product Date (Missing Sell By Date)	No product date printed on the case.	Direct Import: Page 297-304
	Incorrect STOP Label (Incorrect MasterPack Labeling)	STOP label does not include verbiage "Mixed Merchandise Receive as Breakpack" verbiage. Case markings list item specific information including Item Number, Description, Supplier Stock Number or Barcode other than Postal Code. Shipping Label does not list Master Pack as the WM Item Number.	eCommerce: Page 212
	Missing STOP Label (Missing MasterPack Labeling)	All STOP labels are missing from the case.	

■ **NOTE - Defect and Sub-Defect names have been updated. The original name is shown as (x) within the above chart.**

SQEP Supporting Standards, cont...

FixIt Defect	FixIt Sub-Defect	Description	Supporting Standard Location
HAZMAT Compliance	Hazmat Marking Missing	Case is not marked with the required Hazmat Marking.	General Merchandise: Page 224-225 Direct Import: Page 297-304
	Hazmat Marking Covered	Required Hazmat Markings are covered.	
	Lithium-Ion Marking Missing	Case is not marked with the required Lithium-Ion Marking.	
	Lithium-Ion Marking Covered	Required Lithium-Ion Markings are covered.	
	Limited Quantity Marking Missing	Case is not marked with the required Limited Quantity Marking.	
	Limited Quantity Marking Covered	Required Limited Quantity Markings are covered.	
Packaging Compliance	Missing Bottom Tray or Lid	Case or pallet pull not contained with a lid/cover and/or missing the required bottom tray.	Shrink Wrap: Page 209-210
	Loose Wrap	Shrink wrap does not fit tightly around the case and/or has loose ends.	
	Poor Perforations	Perforation breaks open during normal handling.	Case Quality: Page 207-208
	Insufficient Fragile Item Packaging (Poor Packaging for Glass/Ceramic/Fragile)	Packaging for glass/ceramic/fragile items do not meet requirements resulting in loose/easily damaged product.	Fragile Product Packaging: Page 255-256
	Selling Units Not Secured	Selling units freely move inside case/pallet pull resulting in damage. Opening on case too large to keep selling units secured.	Automation Eligible and Ineligible Cases: Packaging_Page 205-206 Case Quality (opening on case): Page 207-208
	Loose or Metal Straps (Loose/Metal Straps or Bands)	Straps or bands are not tight on the case. Metal straps or bands are present.	Automation Eligible and Ineligible Cases: Packaging_Page 205-206 Case Quality (opening on case): Page 207-208
	Packaging Easily Crushed (Weak Packaging)	Corrugate is easily crushed and does not withstand normal handling.	Automation Eligible and Ineligible Cases: Page 205-206 Case Quality: Page 207-208
	Insufficient Glue or Tape (Weak/Lack of Glue/Tape)	Case flaps are not securely sealed with glue or tape.	Case Quality: Page 207-208
	Overpacked/Bulging Case (Oversized/ Undersized Case)	Contents of case results in bulging case.	

■ **NOTE - Defect and Sub-Defect names have been updated. The original name is shown as (x) within the above chart.**

SQEP Supporting Standards, cont...

FixIt Defect	FixIt Sub-Defect	Description	Supporting Standard Location
Pallet Labeling	Mixed Dates Labeling Missing/ Incorrect	"Mixed Date Pallet" placard was not found on all four sides of the pallet. Wrong dates or quantities on the label.	Perishable Labeling Requirements: Page 324
Pallet Securement	Poor Securement	Pallets arrived intact but require additional wrap or securement to maintain stability throughout the warehouse.	Stretch Wrap: Page 246
	Bagged Items Missing Pallet Barrier (Bagged Item Missing Bottom Tray)	Bagged item does not have the required tray, slip or tier sheet between product and pallet.	Unitized Shipments: Page 241
Pallet Build	Pallet Overhang	Freight exceeds the footprint of the pallet.	Unitized Shipments: Page 241-242
	Exceeds Max Pallet Height (Exceeds Max Height for Trailer Type)	Freight exceeds maximum allowable height.	Double Stacking - Inbound to Walmart: Page 237 Direct Import: Page 297-304
	Inaccurate Ti	Cases per layer does not match the pallet build in the item file. IDC: Consistent TI for Shipment	Unitized Shipments: Page 241-242 Direct Import: Page 297-304
Pallet Quality	Poor Quality (Fair Quality)	Pallet does not meet the minimum published requirements in the Walmart Supply Chain Standards.	Pallet Standards: Page 231-234
	Non-Compliant Pallet Size	Pallet is not a standard 48X40 pallet size.	

■ **NOTE** - Defect and Sub-Defect names have been updated. The original name is shown as (x) within the above chart.

SQEP Supporting Standards, cont...

FixIt Defect	FixIt Sub-Defect	Description	Supporting Standard Location
Load Stability	Shifted or Unstable	Freight is leaning or has fallen over inside the trailer and requires rework before being removed from the trailer.	Unitized Stacking: Page 239-240
	Not Palletized	Staple stock freight is not palletized.	
Load Segregation	Pallet not Separated by DA and Staple	DA and SS POs loaded on the same pallet.	Item and PO Configurations: Page 230
	Trailer not Separated by DA and Staple	DA and SS POs not separated on the trailer.	Trailer Loading: Page 247
	Same Item Not Grouped By Layer (Same Item/PO Not Grouped by Layer)	Items column stacked and/or mixed throughout the pallet.	Item and PO Configurations: Page 230
	Same Item & PO On Multiple Pallets (Same Item/PO on Multiple Pallets)	Single pallet or less quantity item spread amongst multiple pallets.	

■ **NOTE** - Defect and Sub-Defect names have been updated. The original name is shown as (x) within the above chart.

Corrugated Board Specifications

To ensure packages get to either Walmart DCs or FCs and to customers in good condition, Walmart has developed the following corrugated board specifications to help maximize the product packing process and minimize damage. The corrugated box chosen must be able to withstand the entire shipping cycle and still retain its protective qualities.

Material Testing

Material testing is critical. Case packs must follow liner weights and box burst tests indicated in Rail Rule 41, using the table on the following pages for minimum requirements. Most large-scale corrugated manufacturers have testing capabilities, either in-house or outsourced.

Gross Weight Limit

This specifies the maximum weight the completely packaged box can contain. This weight limit is published and recognized by the National Motor Freight Industry and is tailored to full truckload and less than truckload carriers.

Specifications for Corrugated Boxes

The chart on the following pages establishes a minimum standard burst test or ECT (edge crush test), depending on the certification test method utilized by the box manufacturer.

These specifications are derived from the National Motor Freight Classification: Item 222. It is the Supplier's responsibility to adequately test and maintain documentation that the boxes produced meet or exceed the strength test certified in BMC printed on the box.

200# Mullen Board Grade - *required*

Palletized displays must be produced with a minimum of 200# Mullen board grade.

Caliper Specifications

A caliper is a commonly used measurement for corrugated packaging and is a good predictor of performance.

The chart of industry-standard calipers on the following pages is to be used as a target for caliper and flute formation for the commonly used corrugated flute types: **A, B, C, B/C, A/C**.

This chart is not all-encompassing, as there are a variety of flute types. It is intended to focus on the most commonly used types for shipping cases and displays.

Box Maker's Certificate (BMC)

A BMC is *required* to be printed on all corrugated cases. The BMC strength should be appropriate for the product weight with a minimum rating of 200 lbs. per square inch.

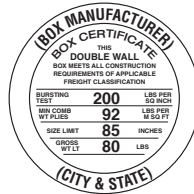
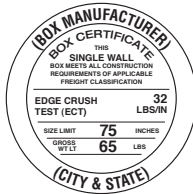

Edge Crush Test (ECT)

A corrugated board test to determine the force that will crush a standard-sized board standing on an edge. ECT indicates the probable compression strength of the container made from the board.

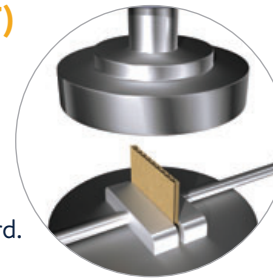

Mullen (Burst) Test

A corrugated board test to measure the pressure required to puncture a sheet of corrugated board as an indicator of its load carrying capacity under specific conditions.

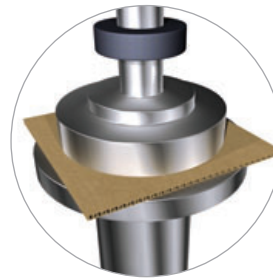

Example (reference chart on following page):

Master Case + Contents = 57 lbs
Measures 39" + 23.6" + 18" = 80.6

1. Using column 2, the correct max loading item is 66-80 lbs.
2. The total girth of this case is 80.6 in. NOTE: This moved to the next higher column as it exceeds the max 75 in. scale.
3. The correct minimum corrugated rating is 250 psi burst strength or 40 ECT.
4. You may achieve the correct corrugated rating using a number of different flute sizes and combinations. Use the charts on the following pages to determine an acceptable combination.

Corrugated Board Specifications, cont...

Max. weight of box and contents (lbs.)	Max. outside dimensions (length + width + depth) in inches	Min. combined weight of facings, including center facings of double wall and triple wall board (lbs. per 1,000 sq. ft.) Min. combined weight of plies, solid fiberboard, excluding adhesives (lbs. per 1,000 sq. ft.)	Min. burst test, single wall or solid fiberboard (lbs. per sq. inch) Min. puncture test, triple wall board (inch oz. per inch of tear)	Min. edge crush test (lbs. per inch width)
SINGLE WALL CORRUGATED FIBERBOARD BOXES				
65	75	84	200	32
80	85	111	250	40
95	95	138	275	44
120	105	180	350	55
DOUBLE WALL CORRUGATED FIBERBOARD BOXES				
80	85	92	200	42
100	95	110	275	48
120	105	126	350	51
140	110	180	400	61
160	115	222	500	71
180	120	270	600	82
TRIPLE WALL CORRUGATED FIBERBOARD BOXES				
240	110	168	700	67
260	115	222	900	80
280	120	264	1100	90
300	125	360	1300	112
SOLID FIBERBOARD BOXES				
20	40	114	125	N/A
40	60	149	175	N/A
65	75	190	200	N/A
90	90	237	275	N/A
120	100	283	350	N/A

Corrugated Board Specifications, cont...

Corrugated Material Caliper Specifications in SAE and Metric (Mullen)

1. Allow .015 cm less than normal for printed areas.
2. Where not specified, medium weight is 30# per msf or 147 grams per square meter.

Single wall board grade		A-flute		B-flute		C-flute	
Lbs.	Kg/cm	In	Cm	In	Cm	In	Cm
125#	8.8	.193	.495	.113	.290	.151	.387
150#	10.5	.195	.500	.115	.295	.153	.392
175#	12.3	.199	.510	.119	.305	.157	.392
200#	14.1	.201	.515	.121	.310	.159	.408
200# + 33# medium	14.1 + 161 GSM medium	.204	.523	.123	.315	.162	.415
200# + 36# medium	14.1 + 176 GSM medium	.206	.528	.124	.318	.164	.421
200# + 40# medium	14.1 + 195 GSM medium	.207	.531	.125	.321	.165	.423
250#	17.6	.207	.531	.127	.326	.165	.423
250# + 33# medium	17.6 + 161 GSM medium	.210	.538	.129	.331	.168	.431
250# + 36# medium	17.6 + 176 GSM medium	.212	.544	.130	.333	.170	.436
250# + 36# medium	17.6 + 195 GSM medium	.213	.546	.131	.336	.171	.438
275#	19.3	.213	.546	.133	.341	.171	.438
275# + 33# medium	19.3 + 161 GSM medium	.216	.554	.135	.346	.174	.446
275# + 36# medium	19.3 + 176 GSM medium	.218	.559	.136	.349	.176	.451
275# + 40# medium	19.3 + 195 GSM medium	.219	.562	.137	.351	.177	.454
350#	24.6	.223	.572	.143	.367	.181	.464
350# + 33# medium	24.6 + 161 GSM medium	.226	.579	.145	.372	.184	.472
350# + 36# medium	24.6 + 176 GSM medium	.228	.585	.146	.374	.186	.477
350# + 40# medium	24.6 + 195 GSM medium	.229	.587	.147	.377	.187	.479

Double wall board grade		B/C-flute		A/C-flute	
Lbs.	Kg/cm	In	Cm	In	Cm
200#	14.1	.258	.662	.338	.867
275#	19.3	.264	.677	.344	.882
350#	24.6	.274	.703	.354	.908
500#	35.2	.294	.754	.374	.959
600#	42.2	.308	.790	.388	.995

Required Package Testing

Package Testing Requirements for: National Brands

Overview of Walmart Package Testing Requirements

The purpose of transit testing high damage risk products is to ensure packaging quality is sufficient to withstand the rigors of delivery to the customer. Passing transit tests will reduce damage returns and improve the customer experience.

All new and existing domestic and direct import items should be transit tested before being shipped to Walmart/Walmart's customer.

Transit test reports are valid indefinitely if no change occurs to the packaging and return rates are below the department average.

Testing Process

Suppliers will be responsible for transit testing their items if they fall within the **required** categories shown on the following pages. The Supplier will submit a production sample of the item to any ISTA-certified lab for testing. Any changes to packaging or product after this will **require** a retest.

Like items (identical products and packages with different colors and/or finishes) **require** package testing on only one item. The remaining colors and/or finishes are waived.

Completed Transit Tests

Once the transit test results are complete, the supplier or global sourcing partner must submit a copy to ISTATesting@wal-mart.com.

Walmart may request a retest for items with rates above department average.

NOTE - Any exceptions to required testing must be approved by the Inbound Quality Senior Manager at: logpkg@wal-mart.com.

Large-screen TVs are required to pass a Walmart-specific TV test protocol.

Testing Collection

Once ISTA Tests are completed they need to be submitted to Walmart for record. Reference the following pages that outline in detail the BU/Department specific test collection/submission requirements.

For Departments that fall under the "Email Test Collection" process, please abide by the following:

Email Subject Line Format:

BU[HOME, ETS, HARDLINES]_DEPARTMENT [D#]_NationalORPrivate&Exclusive Brand[NAT OR PB]_SUPPLIER NAME_IMPORTorDOMESTIC_ISTA TEST TYPE [ISTA6A, ISTA3A,, ISTA3B]_DATE OF ISTA TEST COMPLETED[MMDDYYYY]

Examples:

- HOME_D17_PB_COMPANY NAME_ IMPORT_ISTA6A_092722
- ETS_D7_PB_COMPANY NAME_DOMESTIC_ISTA3A_110221
- HARDLINES_D9_PB_COMPANY NAME_DOMESTIC_ISTA6A_032922

Required Package Testing, cont...

Walmart National Brand Testing Requirements

CRITERIA: These requirements are applicable to national brand items that do not fit into the categories shown on the following pages.

Requirement 1: SIOC (Items should have a “Do Not Open” label and a readable UPC on at least 1 side)

- Any item shipped into Walmart as a 1/1 item
- Any single side of case is greater than 25" in length OR
- The second largest side of case is greater than 20" in length OR
- The smallest side of case is greater than 14" in length OR
- The case weighs more than 30 pounds OR
- Volume is greater than 3.25 cubic feet OR
- Any item defined as “collectible”

Walmart National Brand Transit Testing – Flow Chart

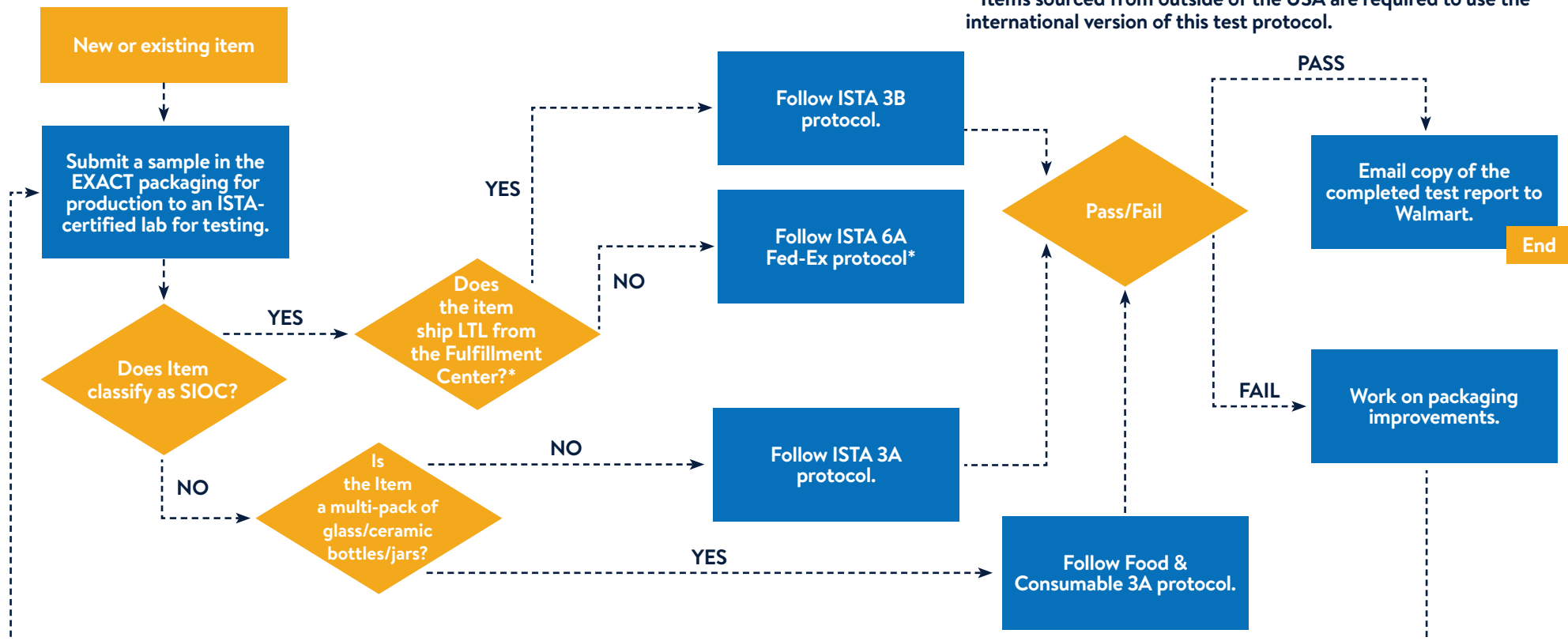

Completed Transit Tests

Once the transit test results are complete, the supplier or global sourcing partner must submit a copy to ISTATesting@wal-mart.com.

Walmart may request a retest for items with rates above department average.

• **If any one of the following conditions are met, item will ship LTL:**

- >150lbs
- >108" in longest dimension (9ft)
- >165" in length (L) + girth (2W+2H)

If none of the above are met, package will travel small parcel carrier.

* **Items sourced from outside of the USA are required to use the international version of this test protocol.**

Required Package Testing, cont...

Package Testing Requirements for: Walmart Private and Exclusive Brands

Overview of Walmart Package Testing Requirements

The purpose of transit testing high damage risk products is to ensure packaging quality is sufficient to withstand the rigors of delivery to the customer. Passing transit tests will reduce damage returns and improve the customer experience.

All new and existing domestic and direct import items should be transit tested before being shipped to Walmart/Walmart's customer.

Transit test reports are valid indefinitely if no change occurs to the packaging and return rates are below the department average.

Testing Process

Suppliers will be responsible for transit testing their items if they fall within the **required** categories shown on the following pages. The Supplier will submit a production sample of the item to any ISTA-certified lab for testing. Any changes to packaging or product after this will **require** a retest.

Like items (identical products and packages with different colors and/or finishes) **require** package testing on only one item. The remaining colors and/or finishes are waived.

Completed Transit Tests

Once the transit test results are complete, the supplier or global sourcing partner must submit a copy to ISTATesting@wal-mart.com.

Walmart may request a retest for items with rates above department average.

NOTE - Any exceptions to required testing must be approved by the Inbound Quality Senior Manager at:
logpkg@wal-mart.com.

Large-screen TVs are required to pass a Walmart-specific TV test protocol.

Walmart Testing Protocol

Atmospheric Conditioning will be an added step **required** in all ISTA Tests completed for Walmart Private and Exclusive Brand items within General Merchandise for Direct Import items. Please see the set of Walmart instructions published. Suppliers may obtain a copy of these Walmart instructions for the **required** ISTA Test Protocols on [Retail Link > Academy > Transportation Channels > Packaging and Labeling > Walmart Package Standards/Transit Testing](#).

Clamp Testing (ISTA SAMS CLUB 6A Clamp Test) will be an added step **required** in all tests to be completed for Walmart Private and Exclusive Brand items within General Merchandise. Please see the set of Walmart instructions published. Suppliers may obtain a copy of these Walmart instructions for the **required** ISTA Test Protocols on [Retail Link > Academy > Transportation Channels > Packaging and Labeling > Walmart Package Standards/Transit Testing](#).

Testing Collection

Once ISTA Tests are completed they need to be submitted to Walmart for record. Reference the following pages that outline in detail the BU/Department specific test collection/submission requirements.

For Departments that fall under the "Email Test Collection" process, please abide by the following:

Email Subject Line Format:

BU[HOME, ETS, HARDLINES]_DEPARTMENT [D#]_NationalORPrivate&Exclusive Brand[NAT OR PB]_SUPPLIER NAME_IMPORTorDOMESTIC_ISTA TEST TYPE [ISTA6A,ISTA3A,,ISTA3B]_DATE OF ISTA TEST COMPLETED[MMDYYYY]

Examples:

- HOME_D17_PB_COMPANY NAME_ IMPORT_ISTA6A_092722
- ETS_D7_PB_COMPANY NAME_DOMESTIC_ISTA3A_110221
- HARDLINES_D9_PB_COMPANY NAME_DOMESTIC_ISTA6A_032922

Required Package Testing, cont...

Food Consumables, Health, and Wellness Testing Requirements: Private and Exclusive Brands

Requirement 1: SIOC (Items should have a “Do Not Open” label and a readable UPC on at least 1 side)

- Any item shipped into Walmart as a 1/1 item
- Any single side of case is greater than 25" in length OR
- The second largest side of case is greater than 20" in length OR
- The smallest side of case is greater than 14" in length OR
- The case weighs more than 30 pounds OR
- Volume is greater than 3.25 cubic feet OR
- Any item defined as “collectible”

Walmart Food Consumables, Health, and Wellness – Flow Chart

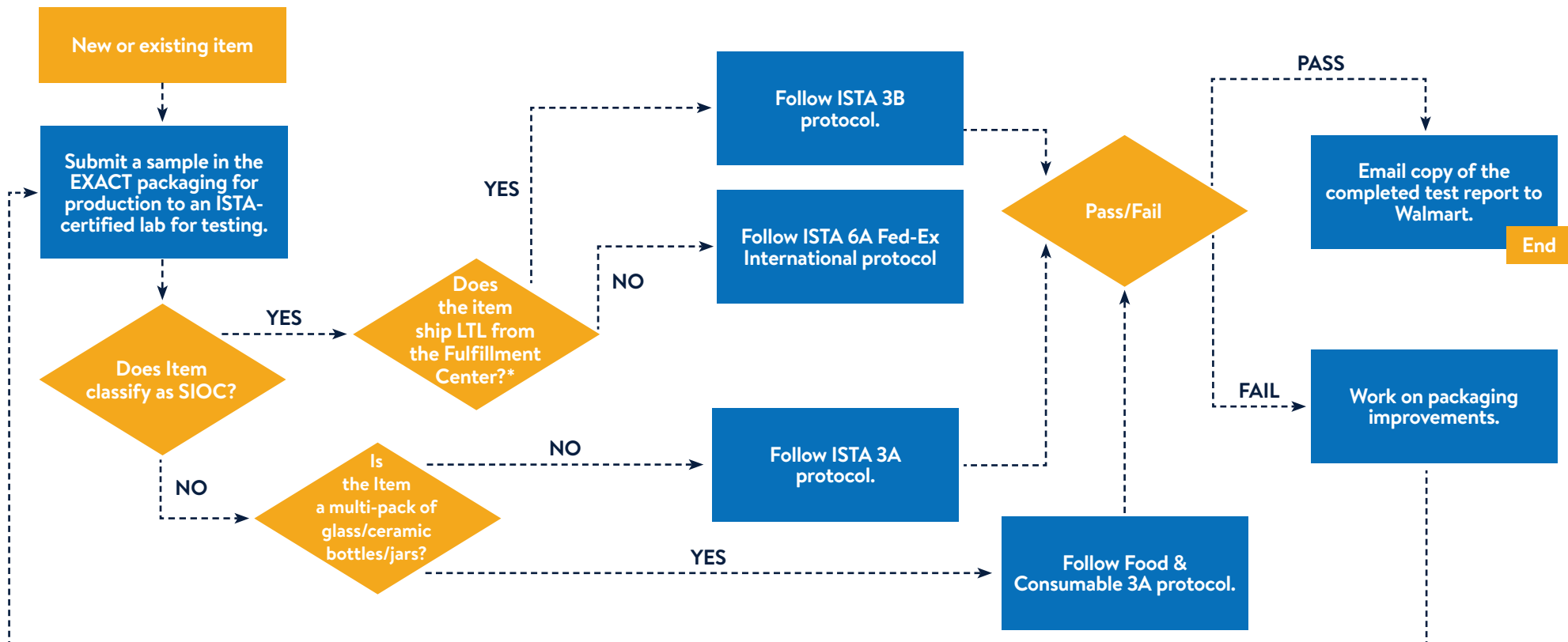

© 2023 Walmart Stores, Inc. The examples shown are for reference only.

Completed Transit Tests

Once the transit test results are complete, the supplier or global sourcing partner must submit a copy to ISTATesting@wal-mart.com.

Walmart may request a retest for items with rates above department average.

- **If any one of the following conditions are met, item will ship LTL:**
 - >150lbs
 - >108" in longest dimension (9ft)
 - >165" in length (L) + girth (2W+2H)
- If none of the above are met, package will travel small parcel carrier.*

Required Package Testing, cont...

GM Home: Private and Exclusive Brands

If any of the following conditions are met, your product is considered Ships in Own Container "SIOC" and is **required** to ship in its own case:

- Any item shipped into Walmart as a 1/1 item
- Any single side of case is greater than 25" in length OR
- The second largest side of case is greater than 20" in length OR
- The smallest side of case is greater than 14" in length OR
- The case weighs more than 30 pounds OR
- Volume is greater than 3.25 cubic feet OR
- Any item defined as "collectible"

■ **NOTE - This page applies to Walmart GM Home: Private and Exclusive Brands items only.**

■ **NOTE - Suppliers may obtain a copy of Walmart's instructions for the required ISTA Test Protocols on Retail Link > Academy > Transportation Channels > Packaging and Labeling > Walmart Package Standards/Transit Testing.**

Walmart Home Private Brands Transit Testing – Flow Chart

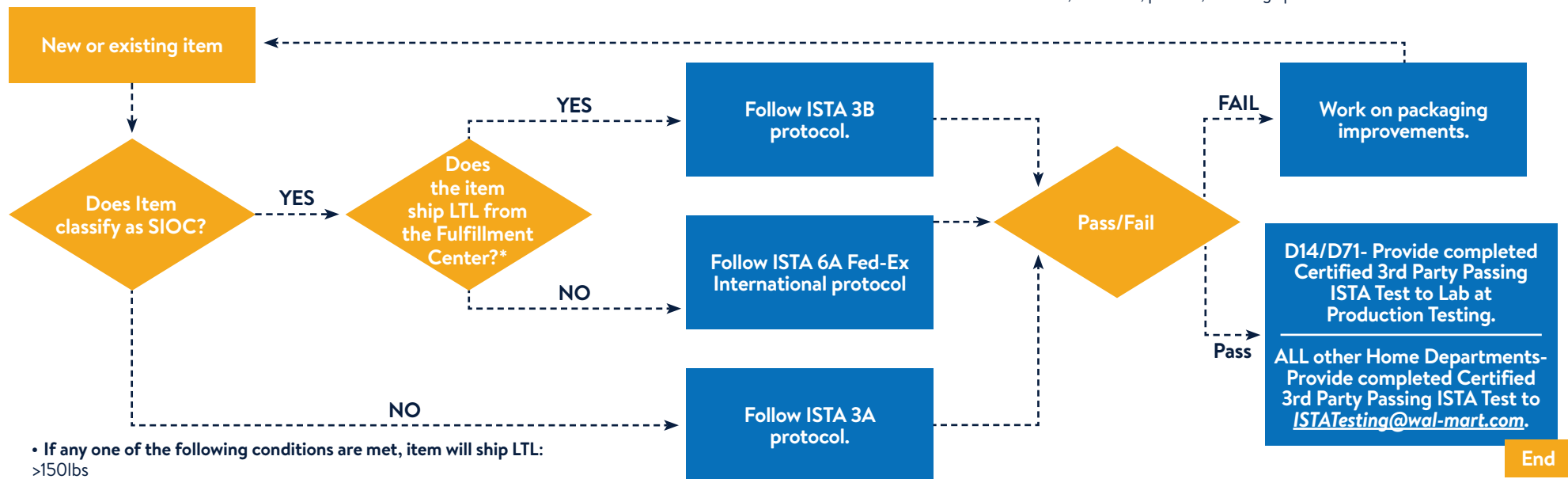

- If any one of the following conditions are met, item will ship LTL:
>150lbs
>108" in longest dimension (9ft)
>165" in length (L) + girth (2W+2H)
If none of the above are met, package will travel small parcel carrier.

© 2023 Walmart Stores, Inc. The examples shown are for reference only.

■ **NOTE - Certified ISTA Tests will be collect for D14/D71 during Production Testing. If the proper ISTA testing is not complete, the item will fail product testing.**

Completed Transit Tests

Once the transit test results are complete, the supplier or global sourcing partner must submit a copy to ISTATesting@wal-mart.com.

Walmart may request a retest for items with rates above department average.

Items **exempt** from testing requirements shown below:

Soft Goods, including but not limited to:

- D14: napkins, placemats, tablecloth/runner
- D17: pillows, fabric curtains
- D19: fabric, yarn
- D20: towels, curtains/liners, bath rug
- D22: sheets, blankets, pillows, bedding/quilt sets

End

Required Package Testing, cont...

GM Entertainment, Toys and Seasonal (ETS): Private and Exclusive Brands

If any of the following conditions are met, your product is considered Ships in Own Container "SIOC" and is **required** to ship in its own case:

- Any item shipped into Walmart as a 1/1 item
- Any single side of case is greater than 25" in length OR
- The second largest side of case is greater than 20" in length OR
- The smallest side of case is greater than 14" in length OR
- The case weighs more than 30 pounds OR
- Volume is greater than 3.25 cubic feet OR
- Any item defined as "collectible"

■ **NOTE** - This page applies to Walmart GM ETS: Private and Exclusive Brands items only.

■ Large-screen TVs are required to pass a Walmart-specific TV test protocol.

Walmart ETS Private Brands Transit Testing – Flow Chart

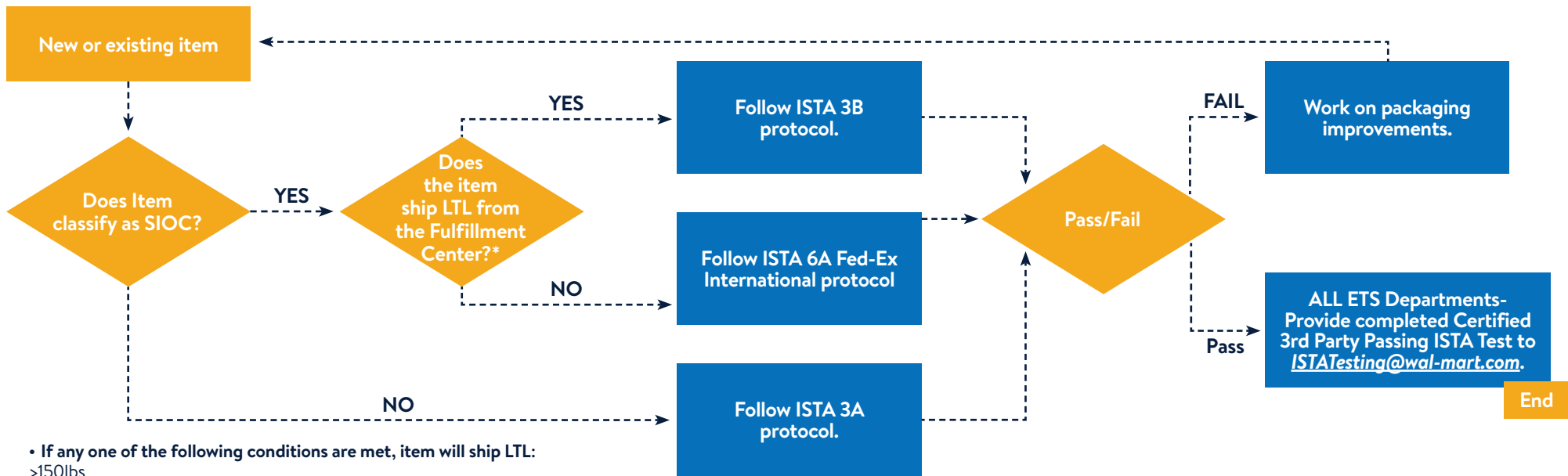

- If any one of the following conditions are met, item will ship LTL:
 - >150lbs
 - >108" in longest dimension (9ft)
 - >165" in length (L) + girth (2W+2H)
- If none of the above are met, package will travel small parcel carrier.

■ **NOTE** - ISTA testing once completed should be sent to ISTATesting@wal-mart.com.

■ **NOTE** - Suppliers may obtain a copy of Walmart's instructions for the **required ISTA Test Protocols** on Retail Link > Academy > Transportation Channels > Packaging and Labeling > Walmart Package Standards/Transit Testing.

Completed Transit Tests

Once the transit test results are complete, the supplier or global sourcing partner must submit a copy to ISTATesting@wal-mart.com.

Walmart may request a retest for items with rates above department average.

Items **exempt** from testing requirements shown below:

Soft Goods, including but not limited to:

- D7: stuffed animals
- D18: Halloween Costumes, Cutlery, Paper plates/cups

Required Package Testing, cont...

GM Hardlines: Private and Exclusive Brands

If any of the following conditions are met, your product is considered Ships in Own Container "SIOC" and is **required** to ship in its own case:

- Any item shipped into Walmart as a 1/1 item
- Any single side of case is greater than 25" in length OR
- The second largest side of case is greater than 20" in length OR
- The smallest side of case is greater than 14" in length OR
- The case weighs more than 30 pounds OR
- Volume is greater than 3.25 cubic feet OR
- Any item defined as "collectible"

NOTE - This page applies to Walmart GM Hardlines: Private and Exclusive Brands items only.

NOTE - ISTA testing once completed should be sent to ISTATesting@wal-mart.com.

Walmart Hardlines Private Brands Transit Testing – Flow Chart

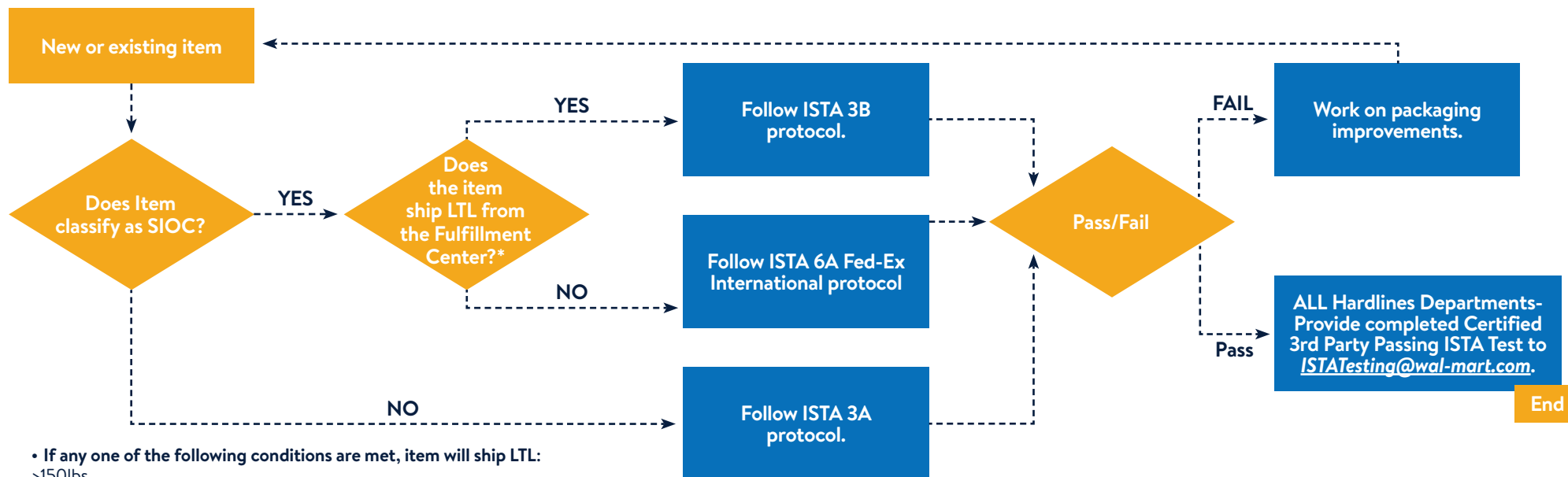

- If any one of the following conditions are met, item will ship LTL:
>150lbs
>108" in longest dimension (9ft)
>165" in length (L) + girth (2W+2H)
- If none of the above are met, package will travel small parcel carrier.

© 2023 Walmart Stores, Inc. The examples shown are for reference only.

NOTE - Suppliers may obtain a copy of these required Walmart ISTA Test Protocols on [Retail Link > Academy > Transportation Channels > Packaging and Labeling > Walmart Package Standards/Transit Testing](#).

Completed Transit Tests

Once the transit test results are complete, the supplier or global sourcing partner must submit a copy to ISTATesting@wal-mart.com.

Walmart may request a retest for items with rates above department average.

Items **exempt** from testing requirements shown below:

Soft Goods, including but not limited to:

- D9: Camping and sports clothing apparel, sports towels
- D10: Cleaning towels
- D11: Safety gloves
- D16: Seat cushions, throw pillows

End

Required Package Testing, cont...

Case Pack Definitions for ISTA Testing

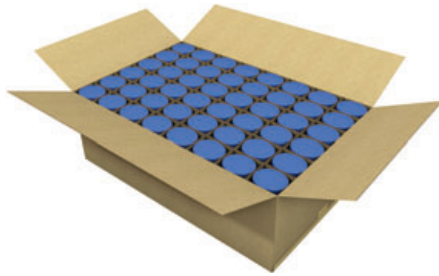

A – Case pack (shipping carton) with multiple selling units.



B – Case pack (break pack/ shipping carton) contains more than one warehouse pack. Each warehouse pack contains more than one selling unit.



C – Case pack (break pack/ shipping carton) contains more than one warehouse pack. Each warehouse pack contains one selling unit.



D – Ships-as-is/ships in own container (SIOC). Each shipping case is one selling unit.

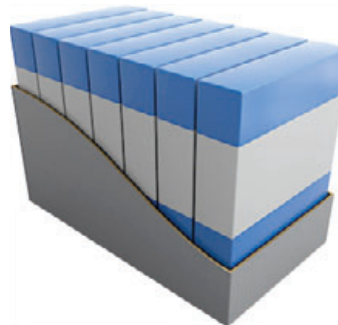

E – Case pack is a less than pallet size PDQ display/SRP (shelf ready package).



F – Unitized Load includes any number of supplier pack cases that are bundled together to move as a single unit. This includes items that are palletized or placed on a slip sheet to be moved through the Walmart Supply chain to store and/or end user as a unitized load.

Case Pack Test Requirement

- A – **Required** ISTA test to be performed on the Shipping Carton.
- B – **Required** ISTA test to be performed on the Warehouse Pack (not the shipping carton)
- C – **Required** ISTA test to be performed on the Warehouse Pack (not the shipping carton)
- D – **Required** ISTA test to be performed on the shipping carton (SIOC package).
- E – **Required** ISTA test to be performed on the PDQ/SRP shipping carton.
- F – **Required** ISTA test to be performed on the Unitized Load.

Case Quality



Case Characteristics	Automation Eligible	Automation Ineligible	Not Acceptable
Within the automation eligible dimensional/weight limits	✓		
Flat, sturdy corrugated packaging	✓		
Tight fitting, supported shrink wrap packaging	✓		
Product with tapered sides, but flat top and bottom surfaces (glass/plastic bottles)	✓		
Packaging has passed required ISTA testing protocols	✓		
Outside the automation eligible dimensional/weight limits		✓	
Bagged products (dog food, potting soil, deer corn)		✓	
Cases with open flaps			✓
Loose shrink plastic, tape, packaging			✓
Bulging or compacted sides			✓
Product falling out of or extending from the top of packaging			✓
Adhesives causing cases to be stuck together			✓
Missing/unreadable packaging barcodes			✓

Receiving Quality

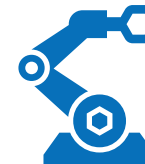

Case Characteristics	Automation Eligible	Not Acceptable
Cases are stacked, stable, and free of damage	✓	
Overall pallet + freight height less than 102"	✓	
Pallet meets minimum quality standards	✓	
Layers leaning or tipped more than 0.5" from base of pallet		✓
Same item stacked on pallet in different height orientations		✓
Cases fall or become unstable when wrap removed		✓
Layers stuck/glued together		✓
Tier sheets stuck/glued between layers		✓
Slip sheets stuck/glued to bottom layer		✓
Missing/unreadable packaging barcodes		✓

Automation Eligible Cases

Automation Eligible Shipping Cases (Vendor Pack Cases)

Packaging and pallet formation must enable product to move successfully from the Supplier to the store shelf through the most efficient distribution process available. Where conveyors and/or robotic technology are used, the product will be clamped and/or conveyed to maximize operations within the distribution center.

GENERAL MERCHANDISE

Minimum requirements

6.4" L x 5.0" W x 2.0" H (minimum 1 lb.)
163mm x 127mm x 51mm (0.45 kg)

Maximum requirements

36" L x 24" W x 16" H (maximum 50 lbs.)
915mm x 610mm x 407mm (23 kg)

REFRIGERATED/FROZEN

Minimum requirements

6" L x 4.0" W x 2.0" H (minimum 1 lb.)
153mm x 102mm x 51mm (0.45 kg)

Maximum requirements

26" L x 20" W x 19" H (maximum 50 lbs.)
661mm x 508mm x 483mm (23 kg)

Automation eligible cases and packaging may be subjected to heavy compression on rollers and belts, as well as vibration, abrasion, temperature, and humidity changes during normal DC handling and processing. Automation eligible cases and packaging, other than glass items, are **required** to withstand a 3-foot drop test.

Automation Eligible Warehouse Packs (Inner Packs)

If the warehouse pack meets the automation eligible case requirements, every effort should be made to set the item up with the buyer as a case pack. It is very inefficient for the DC to handle automation eligible freight through the break pack process.

Automation Eligible Cases and Packaging

- Cases are **required** to be free of protrusions on the outer packaging.
- Avoid round or irregular cases or vendor packs.
- Items are **required** to be tightly secured within their corrugated case or tray with minimal head space to prevent shifting during handling.
- It is **required** that hazardous and liquid material must be secure enough not to leak if the packaging breaks.
- A Supplier's internal barcode label should not be placed on the top of the case as it may interfere with the conveyor's scanning equipment. It is **NOT ALLOWED** to cover any case GTIN barcode.

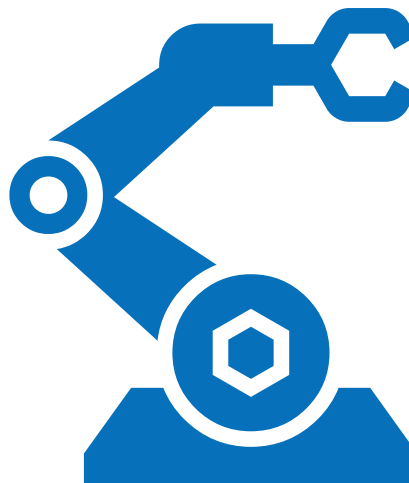

- Avoid using plastic wrap or labels that are highly reflective.
- Black corrugated material and black plastic film are **NOT ALLOWED**.
- Cases should be stacked on the pallet in the automation eligible orientation.
- Pack configurations with an aspect ratio greater than 1.6 (h/w) will be automation ineligible.
- 2" sidewalls are **required** (see "Fragile Product Packaging" section for tray requirements for glass items) and no loose plastic or loose ends. Plastic must be thick enough to avoid tearing or pulling loose through automation. Corrugated board or paperboard sheets with no sidewalls are **NOT ALLOWED**. Lateral support is necessary.
- Automation eligible cases not properly packaged negatively impact the speed and efficiency of freight flow through the DCs. Poor or insufficient packaging will increase overall Supplier costs by adding delays to the store and additional case handling into the shipping process, thereby reducing supply chain efficiency.

NOTE - Refer to the "Fragile Product Packaging" section of this guide for additional requirements on fragile items.

NOTE - D4 – Consumer Paper Goods Items are exempt from the 85" pallet height requirement.

See ISTA Testing section of this guide to review required package performance testing for your items.

Automation Ineligible Cases

Automation Ineligible Cases

While automation eligible cases are preferred, not all cases and packaging can be inducted into the Walmart RDC automation.

Some items are too large or awkward to be automation eligible; for example, bicycles, outdoor furniture, lawn mowers, large TVs, tires, garden tools, and long rugs. These items exceed the maximum dimensions and weight for automation eligible cases but are acceptable automation ineligible items.

GENERAL MERCHANDISE

Maximum Allowable Size *requirements*

72" L x 48" W x 72" H
1829mm x 1219mm x 1829mm

Any single item larger than the dimensions shown above require supply chain approval before shipping into a Walmart DC. Send request for approval to logpkg@wal-mart.com.

Items that are approaching our maximum allowable size shown above are **required** to maintain a flat top surface in order to allow for stacking within the supply chain.

The maximum height for a pallet pull is 85" without a pallet. This is also the maximum height when creating a configuration for a pallet pull item. A pallet pull is an item that is shipped to stores as an entire pallet. **The maximum height for automation ineligible cases with a pallet is 90".**

Straps and Bands

Straps or bands for vendor packs must be tight on the case. Loose bands may damage to conveyors and automation systems. Metal banding is **NOT ALLOWED**. Banding together multiple vendor pack cases is **NOT ALLOWED**.

Straps and bands are allowed on produce pallets and automation ineligible items such as swing sets, tables, or other heavy merchandise over 55 lbs.

NOTE - Straps or bands are NOT ALLOWED on automation eligible merchandise shipped to the eCommerce Network.

Edge Casters or Wheels

Edge casters or wheels integrated into cases that meet automation eligible guidelines are **NOT ALLOWED**. Edge casters or wheels on all automation ineligible cases must be approved by the Walmart Inbound Quality Senior Manager for Packaging before use. Send request for approval to logpkg@wal-mart.com.

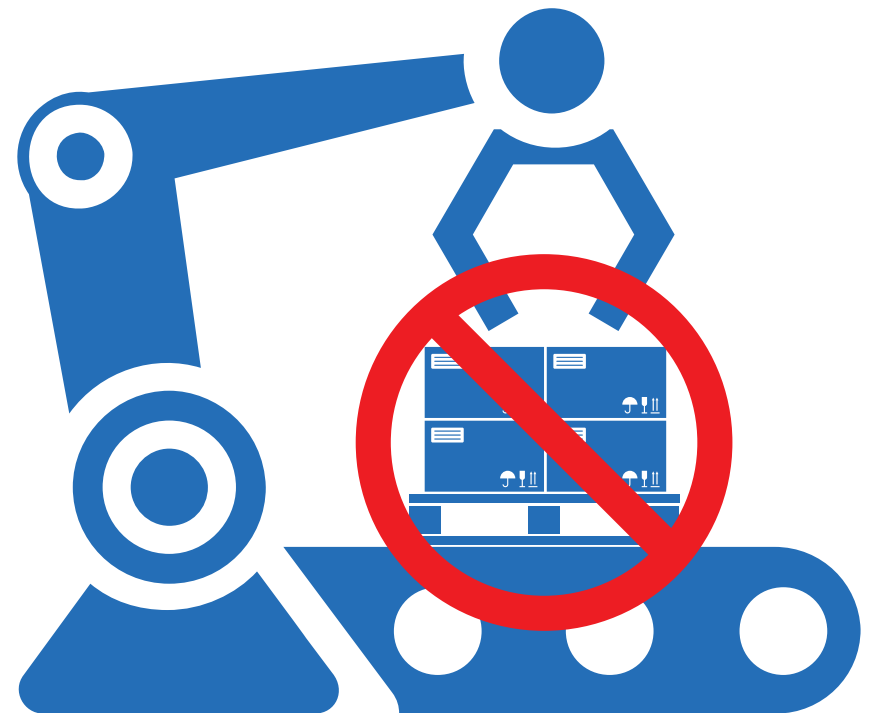

NOTE - Do not ship cases of merchandise in metal racks or metal crates without the written approval of Walmart Supply Chain.



Source Sustainably
Get credit for improving your packaging by joining Project Gigaton.

Case Quality

Adhesives

Corrugated box flaps are **required** to remain secure with an adhesive that can withstand automated handling, compression, humidity, and a range of temperatures.

Sealing and Opening Cases

Case flaps are **required** to be securely sealed using adequate glue or tape. Use water-resistant tape for cold/wet perishable and freezer items. For heavy merchandise, use tape with reinforcing fibers along all seams.

- Avoid large gaps between case flaps. Gap flaps larger than 1" are **NOT ALLOWED** on any side of the case.



Paper sealing tape

Full length of all outer seams securely sealed with strips not less than 2" (50 mm) wide.



Reinforced tape

Full length of all outer seams securely sealed with strips not less than 2" (50mm) wide.



Pressure-sensitive tape

Full length of all outer seams securely sealed with strips not less than 2" (50 mm) wide. Tape must not be less than 2 mils thick.

Vibration and Abrasion

Quality packaging is **required** for containers to withstand the rigors of automation technologies.

This is particularly important for:

- Heavy merchandise with relatively small footprints that concentrate pressure on a very small area of the container.
- Containers using shrink wrap or stretch wrap for containment.
- Items packaged in glass containers.

Container Surface

All cases and packaging surfaces are **required** to be flat and strong enough to support their weight and the weight of other cases placed on top without distortion, deflection, or bending.

Avoid placing products that taper towards the top in trays.

This creates an uneven surface for stacking. An example is a wide bottle with a narrow neck.

- Bottom of cases are **required** to have a flat and smooth surface.
- Bulging in cases due to over-packed contents or collapsing due to excessive air space is **NOT ALLOWED**. Surfaces are **required** to extend no more than 0.25 inches from flat.
- Cases are **required** to be properly sized to contain the product.



ACCEPTABLE

Flat, smooth surfaces



NOT ACCEPTABLE

Bulging, collapsing, or otherwise uneven surfaces

NOTE - Paper Wrap is allowed only with prior approval from the Walamrt Inbound Quality Senior Manager. Send request for approval to logpkg@wal-mart.com.



Case Quality, cont...

Compression

Cases are **required** to be able to withstand side-to-side and end-to-end compression that normally occurs on a DC conveyor and automation system. Reduce air space within a case to avoid product damage. If your product is packaged in perforated cases, ensure they comply with the proper compression standards. Chipboard is not acceptable corrugated material for vendor pack cases.

Perforated Cases

Perforated cases are **required** to be able to withstand warehouse handling, including conveyors and automation, without damage. Passing a 3-foot drop test without failure is a good rule of thumb to gauge success.

Case Orientation and Liquids

Stack cases in the proper orientation that aligns with the vertical flute direction of the corrugated material for optimal stacking strength.

Suppliers are **required** to mark all liquids with “**THIS SIDE UP**” and a directional arrow graphic to indicate the proper case orientation on a minimum of two sides.

■ **NOTE - Arrows are required on liquids, hazardous materials, and fragile items.**

Case and Pallet Handling Markings

Case exteriors should be marked with only the applicable symbols or icons. These symbols will help the shipper, DCs, and stores determine the proper handling necessary for the shipping case to arrive at its destination in good condition. Graphics and descriptions must be large and easy to read. Additional case markings may be **required** by the Walmart Private Label Packaging Team.

Cartons with Openings

Any openings or windows on a case are **required** to be capable of being used as hand holds during the order fulfillment process. Any openings in shrink wrap must fully contain the product within the case or tray. Avoid large gaps between case flaps. Flap gaps of greater than 1” are **NOT ALLOWED** for any side of the case.

In general, holes in the corrugated board should be minimized to maintain the structural integrity of the case and balanced for any temperature and humidity control **required** to maintain product quality.

Open Top Cartons

Open-top cases that are not secured with a lid or plastic shrink film are **NOT ALLOWED**. The only exceptions are perishable items shipped in an RPC or DRC (display ready container) with a 5-down footprint.

Carton Lids

If a lid is used to contain product in a case, the lid is **required** be secured to the case. This applies to all cartons and product containers including plastic clamshell packaging.

Product with Pop-Off Tops

Due to damages to product/containers that have pop-off tops such as, but not limited to, quart/gallon paints, primers, gloss, and rubber coating, these items are **NOT ALLOWED** to be shipped to any Sortable or Non-Sortable Fulfillment Center (eCommerce Network). Failure to adhere to this policy may result in a chargeback to the Supplier.



KEEP AWAY
FROM HEAT



KEEP AWAY
FROM COLD



FRAGILE
HANDLE WITH CARE



HANDLE WITH CARE

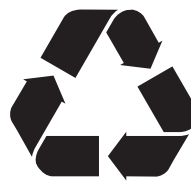

RECYCLE



KEEP DRY



TEAM
LIFT
FOR YOUR SAFETY
FOR ITEMS OVER 50 lbs
DO NOT LIFT ALONE

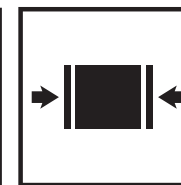

CLAMP AS INDICATED

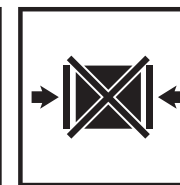

NO CLAMP

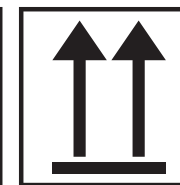

THIS SIDE UP



Optimize Design
Get credit for improving your packaging by joining Project Gigaton.

Case Quality, Shrink Wrap Items

Shrink pack items that DO NOT require a tray

- Refrigerated/frozen items
- Items with all flat surfaces (i.e., corrugated cartons shrink-wrapped together with no gaps)
- Full pallet pull items
- Items that do not meet automation eligible package size or weight requirements

A corrugated tray is required for all shrink pack items not listed in the above chart.

Shrink-Wrapped Trays (Heat Shrink Plastic)

Cases may be contained with shrink wrap as long as the mil (thickness) can withstand abrasion, stacking, or protrusions encountered in normal handling, conveying, loading, and unloading. The case base and top are **required** to be continuous, flat surfaces on all sides. Corrugated trays are **required** to have a minimum 2" high side wall (see "Fragile Product Packaging" section for tray requirements for glass items). Plastic is **required** to fit tightly around the case with no loose ends. Pack sizes with an aspect ratio (height/width) greater than 1.6 are **required** to ship in a full corrugated case and will be automation ineligible. Product shipped in trays is **required** to be weight bearing. Pack configurations with an aspect ratio greater than 1.6 will be automation ineligible. Transparent film is preferred.

Unsupported Shrink-Wrapped Items

Items that are not contained within a 2" side wall or higher tray are considered unsupported shrink wrap items. All shrink pack items are **required** to have a flat top and bottom. When shipping an unsupported shrink pack item that does not have flat surfaces on all sides, a tier sheet is **required** to be placed between each layer including between the bottom layer and the pallet. The tier sheet allows for automated depalletization of product within Walmart distribution centers. Items that ship as a full pallet pull are exempt from this requirement.

Supported Shrink-Wrapped Items (Shrink-Wrapped Trays)

When required, a corrugated tray is **required** to have a minimum 2" high side wall (see "Fragile Product Packaging" section for tray requirements for glass items). Corrugated trays are used to help with automation and conveyance through our distribution centers. The tray will help contain products and protect them from damage that occurs during conveyance and induction into automated facilities. Granule Bags (such as flour or sugar) are **required** to be placed in a tray for conveyance and induction into automated systems within the distribution centers.

NOTE - A tier sheet is required between all shrink pack layers when palletized. This includes a tier sheet between the bottom layer and the pallet. Items with all flat surfaces, supported in a tray, or full pallet pull items are exempt from this requirement.



Unsupported shrink pack
(all flat surfaces)



Unsupported shrink pack
(irregular surfaces)



Supported shrink pack
(tray)

Shrink wrap items can be identified by the bullet hole or seams on each end of the carton.



Case Quality, Shrink Wrap Items, cont...

Corrugated Tray Size and Shape

Shrink pack trays are required to meet Walmart's minimum height requirements as published within the supply chain standards. Some items may become difficult to for customers to shop the products due to the required case height. To minimize this opportunity, suppliers may have u-shaped windows cut into the trays to help improve product visibility and the ease of customers removing the item while on the shelf.

Tray Window Guidelines

- Cutout is **NOT ALLOWED** not exceed 50% of overall tray height.
- Full height corner is **required** to extend beyond 50% of first selling unit contained within the tray.
- Cutouts are allowed on any or all sides of the tray.



Supported shrink pack
(tray w/ window)

Pack Types

Case Handling

The physical appearance and structural integrity of the shipping case are as important to our customer as the commodity itself. It is the responsibility of the Supplier to ensure proper packaging and pallet formation will protect the product as it moves throughout the supply chain.

General corrugated box construction/design should follow the guidelines and recommendations found on ASTM D5118 at www.astm.org and within the Fibre Box Handbook at www.fibrebox.org.

Familiarize yourself with the following pack types and case specifications to ensure efficient processing.

Vendor Pack

- Packages shipped from the Supplier to the DC as specified on the PO.
- Quantity is expressed as the total number of selling units in the case shipped to the DC.

Warehouse Pack

- Packages shipped from the DC to stores.
- Quantity is expressed as the total number of selling units in the configuration the DC ships to the store.
- Warehouse pack is not used within the eCommerce environment.

Parent/Child Assortment is a mix of items within a vendor pack containing a Master Item/UPC (Parent) that represents multiple unique item numbers with a variety of color and sizes (child).

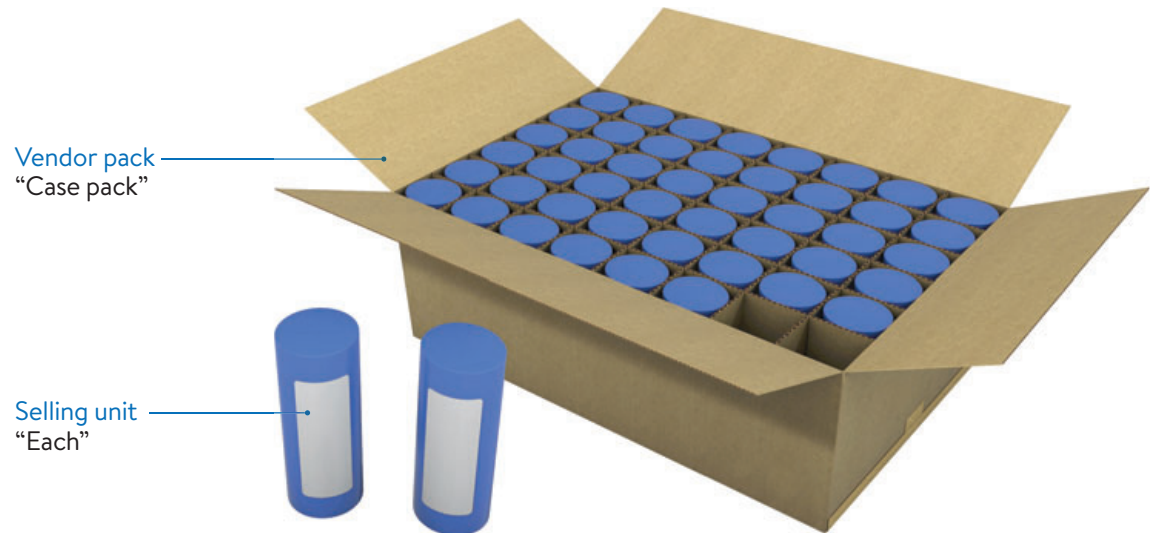

Pack Types, cont...

Master Pack

- Packages shipped from the Supplier to a DC with multiple vendor packs inside one case are **NOT ALLOWED**.
- Master packs are allowed in **eCommerce network with prior approval only**. Contact the Packaging/Labeling team at labeling@walmart.com for approval.

Mixed Master Pack

- A mixed master pack is a package shipped from the seller to the Fulfillment Center that contains multiple vendor packs inside a single case.
- It is not recommended to ship in mixed master packs. Purchase orders are written specifying the number of vendor packs ordered and that should be the quantity configuration.
- To ship in a configuration different than what the PO specifies may result in delayed payment, claims, wrong quantities to customers, delayed processing, product refusal, and many other issues.
- Within the eCommerce environment, smaller items may **require** mixed master packing. If your vendor pack does not meet the minimum automation eligible sort requirements, you are **required** to contact the Packaging/Labeling Team at: labeling@walmart.com for approval of mixed master packing.
- Supplier is **required** to apply three “STOP labels” to master case.
 - One on each long side
 - One on top
 - At least one “Stop label” is **required** to be placed near the domestic shipping label
- “STOP labels” are **required** to:
 - Use the following language: “STOP | MIXED MERCHANDISE | RECEIVE AS BREAK PACK”
- “STOP labels” are recommended to use:
 - Font: **Arial Bold** | Minimum of 48 pt | **ALL CAPS** (smaller font may be used if master case is prohibitively small)
 - Use red ink on a white background (black ink on a white background is acceptable).
- Domestic shipping label is **required** to state “MASTER PACK” in WMIT field.

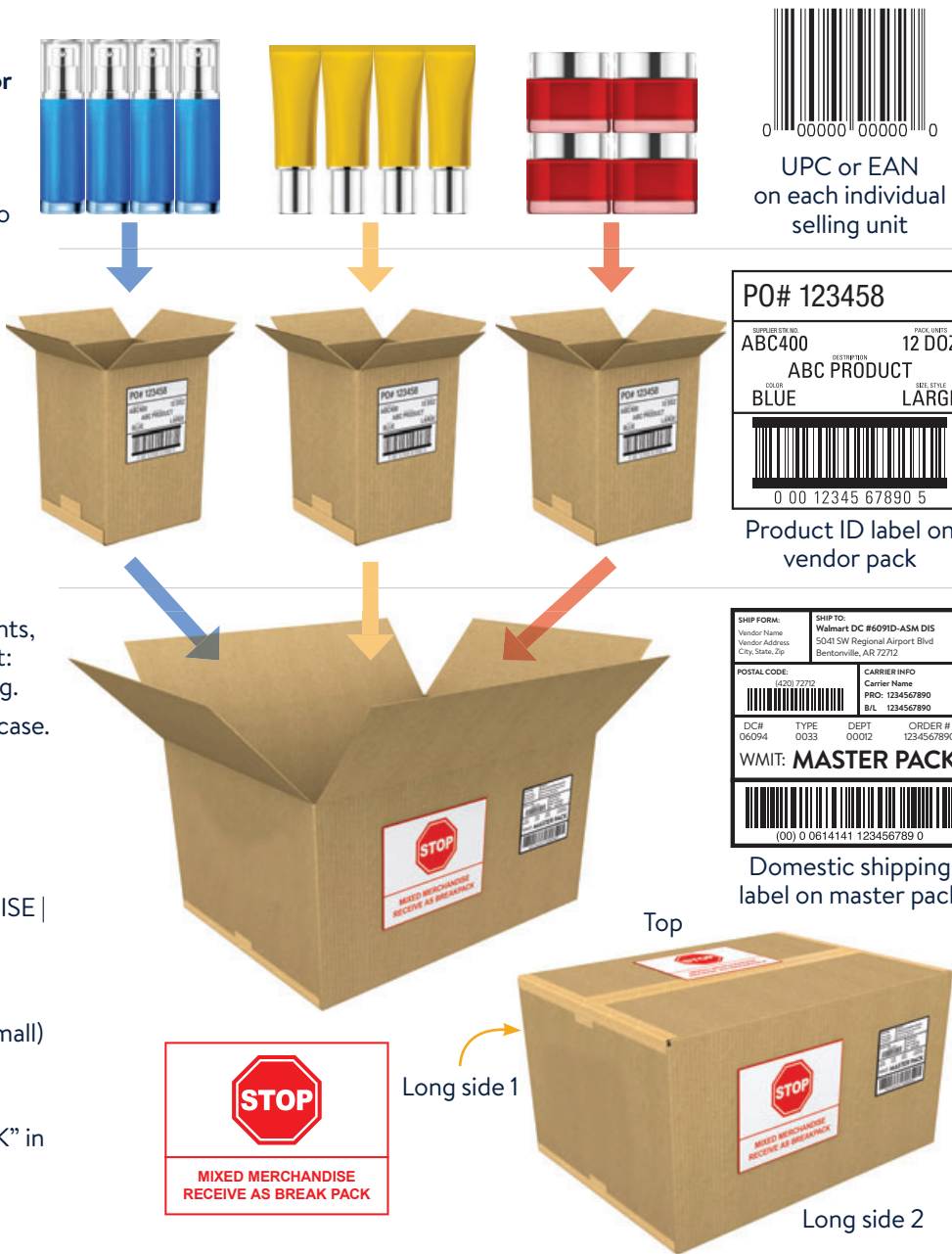

0 00000 00000 0
UPC or EAN
on each individual
selling unit

Selling Unit
Selling unit must be individually packaged (poly bag or case) and placed within the corresponding vendor pack.

PO# 123458
SUPPLIER STRIP NO: ABC400 PACK UNITS: 12 DOZ
PRODUCT: ABC PRODUCT
COLOR: BLUE SIZE: LARGE

0 00 12345 67890 5

Vendor Pack
Each vendor pack is **required** to contain applicable case markings (Product ID info) and orderable GTIN barcode in either ITF-14 or GS1-128 format. If possible, include WMIT.

SHIP FROM: Vendor Name, Vendor Address, City, State, Zip
SHIP TO: Walmart DC #6091D-ASM DIS, 5041 SW Regional Airport Blvd, Bentonville, AR 72712
POSTAL CODE: 72712
CARRIER INFO: Carrier Name, PRO: 1234567890, B/L: 1234567890
DC#: 06094 TYPE: 0033 DEPT: 00012 ORDER #: 1234567890
WMIT: **MASTER PACK**

(00) 0 0614141 123456789 0

Master Case
Barcodes other than the postal code and the SSCC-18 are **NOT ALLOWED** on the domestic shipping label for master packs.

Combining multiple POs within the same master pack case is **NOT ALLOWED**.

“STOP label” is **required** to be clearly indicated on or alongside the domestic shipping label.

“STOP label” is **required** to be included on the two long sides of the master pack case.



Case Pack vs. Break Pack

Case Pack

- Matching vendor pack (shipping case) and warehouse pack (inner pack) quantities.
- The store receives the entire case quantity.

All cases shipping into the GDCs are required to be case packs. The GDCs do not have a break pack process.

NOTE for eCommerce only: If the customer is expected to receive the entire case, then it is required to be set up as 1/1 where "1" represents the number of selling units.

eCommerce shipments should contain warehouse pack quantities at the selling unit level (1). An exception may be made in the event the items are "Shared" with Walmart stores.

Example: Case pack

Store or fulfillment center receives: 1 case of 48

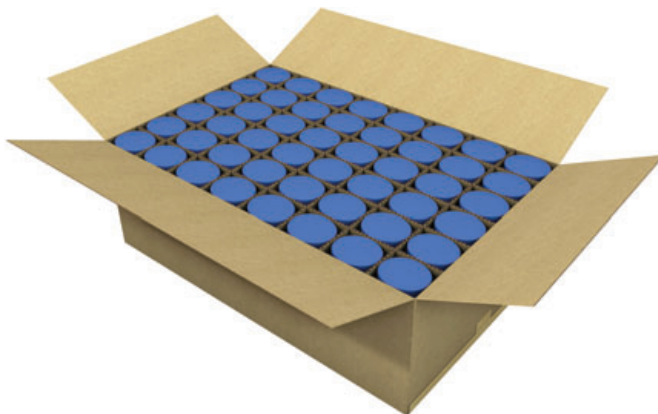

Store and eCommerce Networks
Vendor pack = Qty 48
Warehouse pack = Qty 48

Break Pack

If it is not practical to ship an item to the stores and fulfillment centers in a full case pack quantity and/or the vendor pack case is too small to be automation eligible, your buyer should create the item as a break pack.

- A break pack item is any item with a vendor pack quantity that is larger than the warehouse pack quantity.
- These items are ordered from the Supplier in the vendor pack quantity.
- Within the vendor pack, the Supplier is **required** to securely pack the merchandise according to the warehouse pack quantity.

Example: Break pack = 4 warehouse packs

Store receives: 1 warehouse pack = 12 selling units
Fulfillment center receives: 1 vendor pack = 48 selling units (not ideal for eCommerce network)



Store Networks - Vendor pack = Qty 48
Warehouse pack = Qty 12
eCommerce Network - Vendor pack = Qty 48/
Warehouse pack = 48

- The warehouse pack is **required** to be contained so that the picks do not come loose during the order filling process. If picks collapse and do not remain as a rigid item during handling, this leads to increased handling costs, damages, and delays to stores.
- Break pack items should not exceed 22" x 14" x 16". Approval is **required** for oversize break pack items. Please contact the Walmart Inbound Quality Senior Manager at logpkg@wal-mart.com.

Avoid plastic or cardboard bands or sleeves.

- The store receives the warehouse pack in a larger box packed by the DC with other break pack items.

Items that do not meet the minimum automation eligible case dimensions of 6.4" L x 5" W x 2" H and weigh less than 1 lb. may have to be created as a break pack item.

Example: Break pack = 4 warehouse packs

Store receives: 1 selling unit only
Fulfillment center receives: 4 selling units



Store Networks - Vendor pack = Qty 4
Warehouse pack = Qty 1
eCommerce Network - Vendor pack = Qty 4/
Warehouse pack = 4

Automation Eligible Inner Packs and Plastic Bags

Inner packs are warehouse packs that will be broken out and sent to individual stores by the DC or to individual customers by the FC. Inner packs must be properly secured so the single selling units do not come loose during the order fulfillment process. Plastic or cardboard bands or sleeves are not recommended.

Inner Pack Structural Recommendations

- Inner packs can be subjected to suction of 5 psi over 7 in².
- Avoid macro-scale holes in surfaces of packaging, which can interfere with suction picking process.
- Cases should have flat, sturdy tops with flaps that meet and smooth bottoms.
- Lids should be secured to body of inner pack.
- Ensure containment of selling units within inner pack.
- Inner packs should be able to be engaged as individual units to be picked and separated.
- Product can shift and dislodge if not designed properly.
- Avoid excess glue sticking out from closures.
- Avoid rubber bands, paper-based sleeves, plastic sleeves.
- Black corrugated material and black plastic film are **NOT ALLOWED**.

Poly bags for Inner Packs

Poly bags may be used for inner packs. The poly bag is **required** to be sealed shut so the product does not fall out of the bag during the order fulfillment process. Hangers are **required** to be fully enclosed within the poly bag for all apparel items that include a hanger.

Inner poly bags for apparel are **required** to be clear polyethylene of at least .75 mil thickness with the following specs:

- Low density polyethylene bags are **required**. Walmart encourages the use of Post-Consumer Recycled Content.
- Use only medium slip, high anti-block (a super floss additive that prevents poly bags from sticking together).
- No BHT (BHT is butylated hydroxytoluene and prevents garments from yellowing).
- Poly bags must be puncture-resistant.
- Imports – PE 04 polyethylene bags are acceptable.
- Poly bag packs for the eCommerce network will always be **ONE**. Placing more than one selling unit in a single poly bag is **NOT ALLOWED** in the eCommerce network.
- Poly bags that are **NOT ALLOWED** include dry cleaner bags, import poly bags made from polypropylene (PP).

General Poly bag Requirements

ALL PRODUCTS (except toys) - Plastic bags with a thickness less than one mil (0.001 inch) that have an opening size of 5" or more are **required** to have the following warning.

WARNING: To avoid danger of suffocation, keep this plastic bag away from babies and children. DO NOT use this bag in cribs, beds, carriages, or playpens. This bag is not a toy.

If the total length and width when added together is greater than 40", this warning or an equivalent warning is **required** to repeat at 20" intervals.

The warning is only **required** to be printed in English if all other labeling is only in English. However, if any labeling text (warning, quantity statements, declarations of responsible party, etc.) is translated, all regulatory information is **required** to be translated.

NOTE - Hangtags for apparel garments should be visible through poly bag.

When possible, ensure eCommerce apparel items do not measure greater than 20" x 14" x 2".

Automation Eligible Inner Packs and Plastic Bags, cont...

Toy Products

Total length and width of bag (added together)	Size of print
60 inches or more	at least 24 point
40 to 59 inches	at least 18 point
25 to 39 inches	at least 14 point
Less than 25 inches	at least 10 point

Plastic film bags and flexible plastic sheeting are **required** to be at least 1.5 mil (0.0015 in./0.0381 mm) in nominal thickness, but the actual thickness must never be less than 1.25 mil (0.00125 in./0.03175 mm). Therefore, flexible plastic used with toys cannot be thin enough to require the state warning label.

To assist in your determination of a toy, the Walmart Product Safety and Regulatory Compliance Standards Team has developed a variety of pictorial guidance and decision trees, available on Walmart Retail Link: [Retail Link > Site Map > Product Safety and Compliance Library](#).

Any merchandise that is not completely enclosed in packaging is required to have a sealed poly bag to protect the item. Items with no packaging are NOT ALLOWED.



Open box, no poly bag
NOT ALLOWED



CORRECT
Product sealed
in a poly bag

Poly bags for Blankets, Comforters, and Pillows - eCommerce Only

- Blankets, pillows, and comforters are **required** to be in individual poly bags.
- Comforters are **required** to be in poly bags and placed in a case.
- The front of the poly bag is **required** to have UPC-A barcode at the bottom right.

Poly bags for Rugs, Mats, and Mattresses - eCommerce Only

- Rugs and mats are **required** to be rolled and placed into a poly bag as an individual selling unit.
- Poly bag is **required** to be clear or white.
- Material is **required** to be 3 mil thick or greater.
- Poly bag is **required** to be sealed.
- UPC-A barcode is **required** on the outside of the poly bag.

Poly bags for All Softlines - eCommerce Only

- Merchandise in which the material is a fabric is **required** to be contained within its own case or sealed poly bag.
- Poly bag packs are **required** to be 1/1 (selling unit only). More than one item in a poly bag is **NOT ALLOWED**.
- Examples include, but are not limited to, apparel, plush toys, pillows, and sheets.

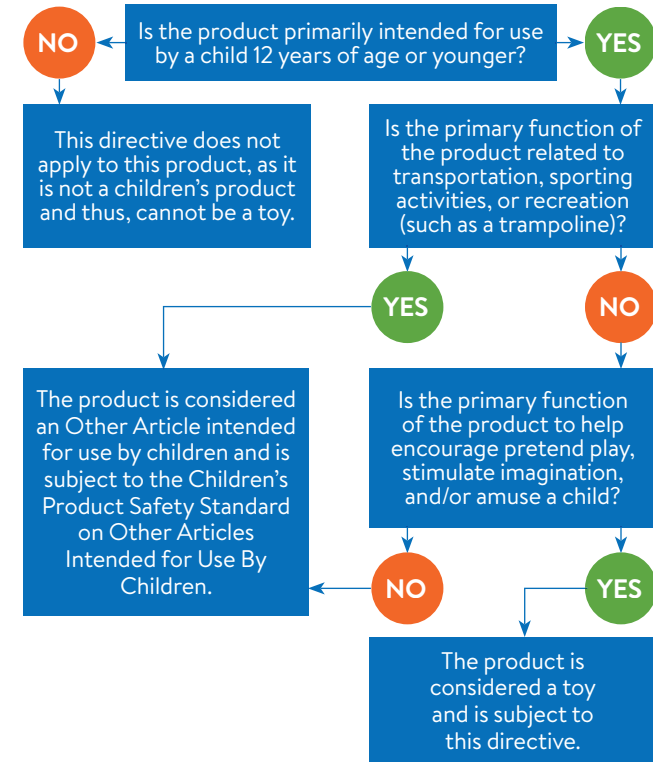

Authority

- Massachusetts – 105 CMR 630.000
- New York – 10 NYCRR § 12.12
- Rhode Island – R.I. Gen. Laws § 11-9-16
- California – Cal Bus & Prof Code § 22200
- ASTM F963

Questions: See the Appendices for plastic bag FAQs. Submit questions to: gmcapply@walmart.com.

GTIN use at Walmart

What is a Global Trade Item Number (GTIN)?

A GTIN is a globally unique number used to identify trade items, products, or services. GS1 defines trade items as products or services that are priced, ordered, or invoiced at any point in the supply chain. Each packaging level is identified by a unique GTIN. For example, a brand will use a different GTIN to uniquely identify their individual selling unit, four selling unit inner pack, and vendor pack case unit of 16 selling units (4 inner packs of 4 selling units each). This unique GTIN will identify item and configuration as it moves throughout the supply chain.

EAN-8



EAN-13



UPC-A



Types of GTIN's used within the Walmart Supply Chain

Walmart makes use of GTIN's in many different ways within our supply chain. The following guide represents common language used within Walmart during item setup for entry of your items GTIN's at varying logistical levels:

Consumable (selling unit) GTIN – the consumable GTIN is assigned to the individual selling unit. This is required to be applied to the selling unit using a point of sale barcode that includes multiple UPC and EAN barcode formats. These GTIN's are often referred to as GTIN-8, GTIN-12 or GTIN-13.

Inner Pack GTIN – the inner pack GTIN is assigned to an inner pack, or break pack, configuration of a case. This is required to be applied to the inner pack carton using a supply chain barcode that includes ITF-14 or GS1-128 formats. This GTIN is often referred to as GTIN-14.

Orderable (Vendor Pack) GTIN – the orderable GTIN is assigned to vendor pack configuration of a case, this is the case that a supplier will use to ship product into Walmart. This is required to be applied to the vendor pack carton of multiple selling units using a supply chain barcode that includes ITF-14 or GS1-128 formats. This GTIN is often referred to as GTIN-14. If your selling

unit is also your shipping unit (often referred to as a 1/1 setup), the use of a UPC-A barcode is acceptable if the consumable GTIN and orderable GTIN for your item are published as the same number in Item 360.

GTIN Creation

GS1 is the global organization that governs the creation and use of the consumable GTIN. All other GTIN's are based on the consumable GTIN for an item. The consumable GTIN is developed by the brand owner using their unique GS1 company prefix, an item reference number, and a check digit that validates the barcode scanner accuracy.

Additional Information

For detailed information on GTIN barcodes, contact the GS1 US: www.gs1us.org.

For information on trade configuration hierarchy, please visit: <https://itemmanager.helpdocs.io/article/0dig3jt5ft-understanding-trade-item-configurations>

ITF-14



GS1-128



14-digit Orderable GTIN Barcode, Character identification

First Digit: Packaging Indicator

Many types of items are produced and distributed in fixed measure nested packaging configurations (e.g., consumer unit, carton, case, pallet) with fixed quantity relationships. The first digit indicator (values 1 to 8) of the GTIN-14 data structure is used to denote these levels of a packaging configuration. The PI is **required** to be unique only within the same item UPC. It is not necessary to maintain the same PI across different items.

When a case contains more than one selling unit of multiple different UPCs, a unique GTIN is assigned.

A new item number is **required** to be assigned for a standard assortment. The assigned item number is **required** to be unique from any other item in your category of products.

Second and Third Digits: Number System Character

To create a GTIN-14, you are **required** to use your full GS1 company prefix which includes the leading zero. If your GS1 company prefix starts with 1-9, continue to use the full prefix. For example:

- If your selling unit UPC is 0 12345 67890 5 – the NN is 00.
- If your selling unit UPC is 6 12345 67890 7 – the NN is 06.
- If the 14-digit case GTIN is based off the EAN-13, a zero should not be inserted.

Digits Four through Eight: Manufacturer's UPC Number

This 5-digit number is always the manufacturer's UPC identification number. When the number system character is added, the complete manufacturer's ID number is six digits long.

Digits Nine through Thirteen: Item ID

There are two ways to assign an item ID:

1. Use the same 5-digit number assigned to the consumable GTIN of the item in the case. Bonus packs, promotional packs, special displays, and product containers with matching UPC item numbers and standard pack replenishment item numbers must be identified by a unique item number used in conjunction with a packaging indicator of 0. On these items, a unique packaging indicator may be used to differentiate these products.
2. Use a unique 5-digit number for each level of packaging of the same product. A unique item number must always be used to identify assortments with more than one consumer package UPC inside the inner case or shipping container. When the item number is different than the product inside the shipping container, you must use 0 as the packaging indicator.

Digit Fourteen: Check Digit

The check digit is based on the data from the other 13 digits and the following formula:

Shipping container code: 0 0012345 67890 5

1. Starting with the packaging indicator, add all the characters in the odd positions.
 $0+0+2+4+6+8+0=20$
2. Multiply the sum by three.
 $20 \times 3 = 60$
3. Add all the characters in the even positions.
 $0+1+3+5+7+9=25$
4. Add the product from the second step to the sum of the third step.
 $60+25=85$
5. The check digit will be the number that gives the next highest multiple of 10 when added to the sum of step 4. $85+5=90$ The check digit is 5.

Use verification equipment to test the shipping container code. Be sure to verify all 14 digits, including the check digit.

Additional Information

For detailed information on shipping container codes, contact the GS1 US: www.gs1us.org.

ITF-14 Orderable GTIN Barcode

14-Digit Case GTIN Interleaved 2 of 5 Barcode

Walmart **requires** the 14-digit supplier pack (orderable) GTIN on all vendor pack cases that contain multiple selling units when shipping to Walmart Distribution Centers, Fulfillment Centers, Consolidation Centers, and Direct Store Delivery. The ITF-14 format barcode is one of 2 acceptable barcode formats to convey the GTIN to Walmart.

- All PDQ displays are **required** to have two 14-digit case GTIN barcodes.
- Bearer Bars around GTIN Barcode are recommended.
- All Barcodes are **required** to have the ability to be scanned by equipment within the Walmart supply chain. Some issues that may affect the ability to scan include, but are not limited to:
 - Print Quality - GTIN and print-and-apply barcodes are **required** to meet or exceed the ANSI standard grade B or higher. Barcodes printed directly on the corrugated board are **required** to meet or exceed the ANSI standard grade C.
 - Size - GTIN is **required** to be compliant with the GS1 Standard. Minimum Allowable Size for GTIN is 3" in length and 3/4" in height.
 - Location - GTIN is **required** to be located at least 3/4" from the edge of the case wall and at least 1.25" from the bottom of the case. If your carton height is less than 2.25" tall the barcode should be centered on the carton.
 - White Space - also referred to as Quiet Zone, is **required** on each end of the printed GTIN. Minimum of 0.25" of white space is **required** on the left and right side of the printed bars. This minimum space requirement is proportional to the overall size of the bar code. Refer to GS1.org for additional detail.
- Barcode is **required** to be scannable through any applied plastic films. Barcode is **NOT ALLOWED** to be applied under a plastic seam or bullet hole.
- Print and apply labels are **required** to maintain a flat surface.
- Ink applied to plastic film, print and apply labels, or any other materials are **NOT ALLOWED** to smear when contacted by another surface.

If you are not able to meet any of these requirements, contact the Walmart Inbound Quality Senior Manager at logpkg@wal-mart.com.

Creating the Shipping Container 14-Digit Case GTIN

It is the Supplier's responsibility to create the 14-digit case GTIN. Walmart does not provide the tools or software necessary to create barcodes.

The 14-digit barcode provides a unique SKU identification number that is cross-referenced at the DC to a specific Walmart item and pack. The 14-digit case GTIN provides additional pack level identification for any given case.

The 14-digit case GTIN is very similar to the 12-digit UPC product code. Both symbols use a unique manufacturer's number that identifies the merchandise producer or labeler and a 5-digit item number assigned by the manufacturer to a specific product.

Additional Information

For detailed information on shipping container codes and barcode specifications, contact the GS1 US: www.gs1us.org.



Red laser scanning devices are blind to red, blue, brown, and shades of purple. DO NOT use these colors when creating your barcode label. Contact logpkg@wal-mart.com for questions on barcode color or background.

Single packed items with only one selling unit in the vendor pack case may use the ITF-14 barcode or the selling unit UPC/EAN barcode. The barcode must be visible on the item when it is received and must match the orderable GTIN published to Item 360. If you use a removable UPC or tear-off UPC label, it must be applied so it can withstand the conditions of the warehouse receiving systems so it does not come off.

GS1-128 Barcode

GS1-128 Barcode

The GS1-128 barcode (data carrier) provides a global standard for exchanging data between different companies. GS1-128 not only encodes the data but also defines the meaning of the data contained within the barcode with the use of Application Identifiers (AI). The GS1-128 barcode (formerly known as UCC/EAN-128) is based on CODE 128 symbology and incorporates the use of a flagging character (FNC1) and Application Identifiers.

Walmart will be expanding the use of data identification and capture methods that align with industry sectors across our end-to-end supply chain. The adoption and deployment of the GS1-128 barcode within the Walmart ecosystem is currently in place for Regional Suppliers in the DSDC Program, Grocery Suppliers for the Produce Traceability Initiative (PTI), Meat, Poultry, and Seafood packaging, DSD Suppliers, and Healthcare Suppliers for the Drug Supply Chain (DSCSA) and Unique Device Identification (UDI) efforts.

Where Walmart Uses the GS1-128 Barcode

A GS1-128 barcode may be used for the following items:

- Supplier Pack (Orderable) GTIN Conveyance:
 - **Required** for Dept 93 – Meat, Poultry, and Seafood cartons.
 - **Required** for Dept 94 – Produce cartons.
 - **Required** for Dept 38 Prescription Pharmaceutical cartons.
 - Optional for all Other Departments.
 - Other data fields may be required within the barcodes for specific items or departments above.
 - Suppliers may add additional data fields into the GS1-128 barcode that are not required by Walmart at their own discretion.
- As an SSCC-18 Logistics Unit Identifier:
 - **Required** on all shipping/pallet labels with the following exceptions: GNFR items, DSV shipments, WFS shipments.

GS1-128 Barcode Physical Attributes

- Bearer Bars around the GS1-128 are recommended but not required.
- All Barcodes are **required** to have the ability to be scanned by equipment within the Walmart supply chain. Some issues that may affect the ability to scan include, but are not limited to:
 - Print Quality - print-and-apply barcodes are **required** to meet or exceed the ANSI standard grade B or higher. Barcodes printed directly on the corrugated board are **required** to meet or exceed the ANSI standard grade C.
 - Size - GS1-128 is **required** to be compliant with GS1 standards. Minimum allowable size for the GS1-128 is 3" L x .75" H.
 - Location - GTIN is **required** to be located at least 3/4" from the edge of the case wall and 1.25" from the bottom of the case. If your carton height is less than 2.25" tall the barcode may be centered on the carton.
 - White Space - also referred to as Quiet Zone, is **required** on each end of the printed GTIN. Minimum of 0.25" of white space is **required** on the left and right side of the printed bars. This minimum space requirement is proportional to the overall size of the bar code. Refer to GS1 for additional detail.
 - Barcode is **required** to be scannable through any applied plastic films. Barcode is **NOT ALLOWED** to be applied under a plastic seam or bullet hole.
 - Print and apply labels are **required** to maintain a flat surface.
 - Ink applied to plastic film, print and apply labels, or any other materials are **NOT ALLOWED** to smear when contacted by another surface.
- If you are not able to meet any of these requirements, contact the Walmart Inbound Quality Senior Manager at logpkg@wal-mart.com.

For questions regarding the electronic submission of ASNs and SSCC, contact EDI support at 479-273-8888.



GS1-128 Barcode, w/SSCC-18 Application Identifier, cont...

GS1-128 Barcode with SSCC-18

SSCC-18 is the GS1 identifier included in an ASN or EPCIS event for traceability of logistical units across the Walmart end-to-end supply chain. Walmart **requires** this barcode standard to be applied in conjunction with ASN or EPCIS information.

SSCC-18 barcode values are used to match the logistical shipping unit with Advanced Shipping Notice (ASN) data. Each Supplier is **required** to comply with matching the ASN "MAN" fields with the SSCC barcode value, as seen in the diagram below.

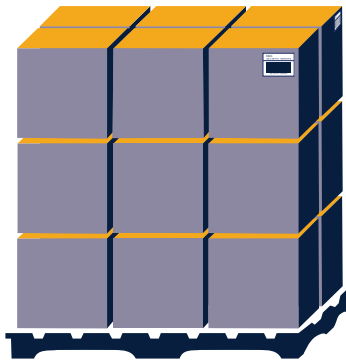

NOTE - For detailed technical requirements, see the EDI 856 Technical Specifications Guide: Walmart Retail Link Path: Retail Link > Academy > Getting Started > EDI.

Case Requirements:

- Department 38 Pharmacy RX shipments
- Shipping a PO Type 73 (DSDC)
- Shipping a PO Type 37 (DSD)
- Small Parcel Shipments
- Floor Loaded Shipments into eCommerce
- Shipments into GM Consolidation Centers

Pallet Requirements:

- All unitized shipments (mixed or single SKU)

NOTE - Suppliers who use a 3rd party consolidator are required to submit an ASN and may utilize a single SSCC-18 barcode that will be used to identify each consolidated supplier PO and/or item that is included on the pallet.

18-Digit GS1-128 Barcode Format

Format the SSCC as follows:

GS1 Application Identifier	SSCC (Serial Shipping Container Code)			
	Extension Digit	GS1 Company Prefix	Serial Reference	Check Digit
0 0	N ₁	N ₂ N ₃ N ₄ N ₅ N ₆ N ₇ N ₈ N ₉ N ₁₀ N ₁₁ N ₁₂ N ₁₃ N ₁₄ N ₁₅ N ₁₆ N ₁₇		N ₁₈

GS1 Application Identifier provides information about the structure of the encoded data. An Application Identifier (AI) is a prefix that identifies the meaning and format of the following data. SSCC-18 barcodes should always use AI "00" which represents the Serial Shipping Container Code data format.

AI	Full Title	Data Title	Format
0 0	Serial Shipping Container Code	SSCC	N ₂ + N ₁₈

Extension Digit can have any value from 0 to 9 and is used to increase the numbering capacity. Its use is at the discretion of the company allocating the SSCC.

GS1 Company Prefix (GCP) is allocated by GS1 Member Organizations to the company that allocates the SSCC, in this case the physical builder or the brand owner of the logistic unit.

Serial Reference is a serial number created by the company allocating the SSCC. The simplest way to allocate the serial number is sequentially, for example ...00000, ...00001, ...00002.

Check Digit is calculated using the algorithm defined by GS1. (GENSPECS, 7.9.1), also see <https://www.gs1.org/services/check-digit-calculator> for calculator.

FNC1 Character is used to distinguish the GS1-128 from regular Code 128 barcodes using the special Function 1 character (FNC1) after the start character.



NOTE - For more detailed information on shipping container codes and barcode specifications, contact the GS1 US: www.gs1us.org.

General Case Markings

General Case Markings

The following information is **required** on a minimum of two sides on all standard shipping cases with at least one side being the longest. Applying markings to both long sides, or one long and one short side, is acceptable. Case markings may be printed directly to the carton, applied by label, or a combination of these 2 methods. Case markings may be applied to more than 2 sides at suppliers discretion.

NOTE - Meat/Poultry/Seafood/Produce/Eggs/D80 Bakery/D98 Deli, and DSV shipments have unique case marking requirements. See those specific sections of this manual for labeling requirements.

The standard shipping case is a full supplier pack case matching the quantity published to Item 360. Suppliers are **required** to ship in the published supplier pack (orderable) case quantity.

- See **ITF-14 and GS1-128 barcode section for additional details on barcode specifications.**
- **Multiple flavor descriptions or multiple unique UPCs are NOT ALLOWED to be printed on the case.**
- When applicable, the Lot Code/Best if used by date is **required** to use a minimum font size of 1/2"/48pt. Preferred date format of **MM/DD/YYYY** (**required** on 1 side only).
- Country of origin (COO) is **required** for all produce. It is recommended for all other items.
- Item 360 is **required** to match what is printed on the vendor case pack, including 14-digit case (orderable) GTIN and Supplier Stock Number. **Verify that the information printed on your cases matches Item 360.**
- One side of the case may be left open to allow for regulated items that **require** a hazardous material marking or label.
- Product ID label is a suggested format only. General Case markings may be applied via label, direct printing to the carton or any combination of these methods.

- The case GTIN barcode (GS1-128, ITF-14, UPCA/E) is **required** to have at least one side facing outward on the pallet/slip sheet if the cases are unitized.
- If your shipping case is also your retail packaging, the selling unit GTIN barcode (UPC-A /E, EAN-13) will satisfy general carton marking requirements. Your selling unit GTIN and orderable GTIN fields in Item 360 are **required** to match in order to use these barcode formats.



Product ID label (example only)

Vendor Pack Case Labeling

Case markings should not be confused with shipping labels. Case markings identify all information that is specific to the shipping case, while the shipping label identifies information that is specific to the PO. General case markings and shipping/pallet labels are 2 separate and unique requirements which must both be met.

Cases that are cylindrical, such as a pail or bucket, only require 1 set of general case markings.

Orderable GTIN Compliance may be met with the use of 2 ITF-14, 2 GS1-128, or 1 of each barcode to convey GTIN information.

REQUIRED

- **14 Digit Supplier Pack (Orderable) GTIN Barcode:** ITF-14 and/or GS1-128 (w/ appropriate application identifier) format, Black ink only
- **Brand/Sub-Brand**
- **Item Description**
- **Case Pack Quantity**
- **Color, Size, or Style:** (when available)

- **Supplier Stock Number:** Must match supplier stock number field published to item 360.
- **Walmart Item Number:** Assortments, shoes, and apparel only
- **Lot Code/Best if used by date:** (when available)
- **Department Number:** Private brand general merchandise items only



Inner Pack Case Markings

Inner Pack Markings

All inner packs flowing through the Walmart Supply Chain need to be properly marked for clear identification of the item.

- Warehouse packs where the UPC-A or EAN-13 barcode is clearly visible: no additional markings are **required**.
- Warehouse packs where the UPC-A or EAN-13 barcode is not clearly visible:
 - A scannable 14-digit GTIN barcode is **required** in either ITF-14 or GS1-128 format w/ appropriate application identifiers.
 - Visible product description is **required**.
 - Supplier Stock Number (internal item number) is **required**.
 - Pack size is **required** for warehouse packs greater than 1.
 - Walmart item number **required** for assortment packs.
 - Private brands may **require** additional markings.
- Apparel Items see FDC section of this guide.



Shrink Pack Tray Case Markings

Shrink Pack Tray Guidelines

- Shrink pack trays have the same case marking requirements as all other cases.
- Product information is **required** to be printed on a minimum of two sides of the tray with at least one side being the longest. Applying markings on both long sides, or one long and one short side, is acceptable.
- The GTIN barcode is **NOT ALLOWED** to be covered by plastic wrap seam.
- Corrugated trays are **required** to have a minimum 2" high side wall (see "Fragile Product Packaging" section for tray requirements for glass items).
- If the dimensions of the item limit the information that can be clearly printed on the tray walls, a label may be used to record the supplier stock number, temperature requirements, best if used by date, and lot codes.
- Recommended label sizes include 4" x 6" and 3" x 4"



Case Weight and Hazmat Case Markings

Weight and Size Considerations

Keep these general guidelines in mind:

- Position graphics on the box so they are visible when the box is stacked.
- Consider placing handhold cutouts in the box to make handling easier for heavy cases.
- A **Team Lift** graphic is **required** on cases weighing over 50 lbs. or when one side of the case measures greater than 44". **Team Lift** icon should be placed on 3 sides of the case (1 on top panel and on both short side panels).
- Cases shipped to Grocery DCs are **NOT ALLOWED** to exceed 50 lbs. unless approved.



FOR ITEMS OVER 50 lbs
DO NOT LIFT ALONE

Hazmat Labeling Compliance

Shipping cases containing hazardous materials are **required** to be marked in compliance with DOT regulations.

- Cases that do not comply with DOT regulations will be re-labeled prior to shipment at the Supplier's expense.
- Hazmat markings are **NOT ALLOWED** to be obstructed or covered by any other labeling.
- Hazmat labels or markings are **NOT ALLOWED** to be folded over the edge of the shipping case.
- Directional arrows are **required** on 2 opposing sides for liquids.



Obstruction of hazmat case markings is **NOT ALLOWED**

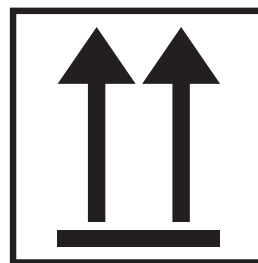

THIS SIDE UP
Required for liquids

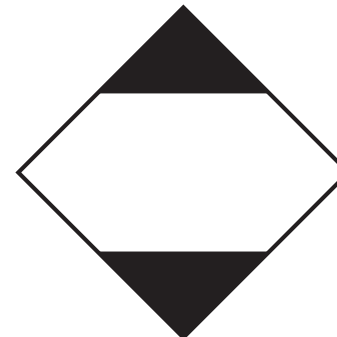

Supplier Notice Regarding Hazardous Materials Package Labeling

Walmart Stores, Inc., including Sam's Club, **requires** Suppliers who ship hazardous materials to any of our facilities to review their package markings and/or labeling to ensure compliance with Dangerous Goods regulations.

Fully-regulated hazardous materials **require** DOT labeling to identify the hazard of the contents. The labeling specifications are found in <https://www.govinfo.gov/content/pkg/CFR-2011-title49-vol2/pdf/CFR-2011-title49-vol2-sec172-407.pdf>. This regulation gives specific guidelines for these labels, including durability, design, color, and size. If your company preprints the **required** labeling on the box instead of using labels, it must also meet the criteria defined in the regulations.

Hazardous materials that take the Limited Quantity exceptions are also standardized. The requirements for these markings are found in <https://www.govinfo.gov/content/pkg/CFR-2011-title49-vol2/pdf/CFR-2011-title49-vol2-sec172-315.pdf>.

Box markings not in compliance with DOT regulations listed above will be **required** to be re-labeled prior to shipment at the Supplier's expense to meet the regulations.

Call the Walmart Compliance Hot-line at **1-800-530-9923** with questions.

Lithium Battery Case Markings

Lithium Battery Requirements

The safe packaging of lithium batteries for transport is dependent on both the type of product and battery being shipped.

One of the major risks associated with the transport of batteries and battery-powered equipment is short circuit of the battery as a result of the battery terminals coming into contact with other batteries, metal objects, or conductive surfaces. Packaged batteries or cells must be separated to prevent short circuits and damage to terminals. They are **required** to be packed in strong outer packaging requiring drop testing or be contained within equipment.

Shipping cases are **required** to be marked with DOT regulations.

- Cases that are shipped to Walmart that do not comply with DOT regulations will be re-labeled prior to shipping to the customer at the Supplier's expense.
- DOT case markings are **NOT ALLOWED** to be obstructed or covered by any other labeling.
- DOT regulated labels are **NOT ALLOWED** to be folded over the edge of the shipping case. (Check with IATA and DOT for instruction when cartons are too small to contain this label size.)
- Li-ion label size is **required** to be a minimum of 5" wide X 4" tall.

Because lithium batteries are considered a dangerous good, it is the Supplier's responsibility to fully understand and comply with all regulations set forth by the IATA and DOT – Pipeline and Hazardous Materials Safety Administration (PHMSA). This guide is not intended to and does not provide legal guidance on compliance requirements that may be applicable to your company. Consult with your company's internal compliance partners and/or counsel to ensure compliant shipments. For additional information regarding this regulation refer to 49 C.F.R. §173.185 or HM 215N in the Federal Register.

Refer to reg. 49 CFR 173.185 for more information. <https://www.govinfo.gov/content/pkg/CFR-2010-title49-vol2/pdf/CFR-2010-title49-vol2-sec173-185.pdf>

Walmart Stores, Inc. **requires** products that are/contain a chemical, aerosol/compressed gas, pesticide, and specific battery types (lead-acid and lithium) to obtain a compliance assessment by <https://www.ulwercsmart.com/> prior to item creation. The assessment data provides Walmart with necessary information to comply with federal, state, and local regulations.



NOTE - Label size requirements may be modified as required only if the minimum size stated will not fit on any panel of the carton without being folded over an edge.

Case Shipping Label - Domestic

Domestic Shipping Labels

Suppliers are **required** to include the information shown below on their shipping labels. Walmart does not provide a template for this label or **require** a specific format for this label. It is the Supplier's responsibility to create the label.

A domestic shipping label is **required** on each case for the following shipments:

- Small parcel shipments
- All floor loaded shipments into eCommerce Fulfillment Centers
- All shipments into GM Consolidation
 - **See Consolidation Section of the Supply Chain Standards for detailed information on Shipping and Pallet Labels when shipping to our Consolidation Centers. Information in this section is not applicable to consolidation centers.**
- If shipping a unitized (palletized) load, see pallet label section

■ **NOTE - See appendix A and B for FedEx and UPS small package labeling instructions.**

The recommended size for shipping labels is 4" x 6" when including the barcode information but can vary with different sized boxes as needed. Standard shipping labels are **required** to contain the following:

REQUIRED	
<ul style="list-style-type: none"> • SSCC-18 Barcode in GS1-128 Format w/ appropriate application identifier 	
RECOMMENDED	
<ul style="list-style-type: none"> • Ship From Address: Suppliers address, city, state, zip code • Ship To Address: Walmart DC address, city, state, zip code and Walmart DC Number (e.g. 6094) • Department number: (Walmart DEPT number, e.g., 00013) • Walmart Item number: (WMIT) 	<ul style="list-style-type: none"> • Department number: (Walmart DEPT number, e.g., 00013) • PO type: (PO TYPE, e.g., 0020) • PO number: 10 digits (<i>ORDER #</i>) • Carrier name (<i>if available</i>) • BOL number (<i>if available</i>) • Pro number (<i>if available</i>)

Label Placement (Individual Case)

Place case shipping labels left of center on the longest side of the case if possible. If the height of the case does not allow, place the shipping label on top of the case. If artwork or graphics printed on case do not allow for label placement left of center, alternative placement is acceptable.

Shipping Label and Barcode Verification

For support on shipping labels, Suppliers can email questions, concerns, and sample labels. Labels will be reviewed to ensure all the **required** information is on the shipping label and that the barcode scans in the correct format. We do not verify that the information on the label is correct. This is the Supplier's responsibility.

Send correspondence to WMBarcodeLabeling@walmart.com.

Ship From: Any Vendor Any Address City, State, Zip	Ship To: Walmart DC 6094A - ASM DIS City, State, ZIP code - GLN address Facility Location - 5 digits	
CARRIER Carrier Name PRO: 1234567890 B/L: 1234567890		
DC# 6094	TYPE DEPT 0033 00012	ORDER# 1234567890
WMIT: 001286123		
 (00) 0 0614141 123456789 0		

Shipping label
(example only)

SSCC-18
(Required)



■ **NOTE - Specific networks may have additional shipping label requirements. Be sure to check with your network standards (e.g., DSDC, RX, etc.) for additional instruction.**

Pallet Shipping Labels - Domestic

Single SKU and Mixed Item Pallet Labels

A pallet label is **required** when shipping unitized items to the Walmart Distribution and Fulfillment Centers. Walmart does not provide a template for this label or require a specific format for this label. It is the Suppliers responsibility to create the label.

The **SSCC-18 barcode** is the **required** barcode format for all pallet labels. A Mixed Item pallet label is **NOT ALLOWED** to contain the orderable GTIN in either ITF-14 or GS1-128 formats.



- Pallet labels are **required** on at least 2 adjacent sides of the pallet, preferred on the upper right corner. It is best practice to place the label between layers of stretch wrap.
- The use of SSCC-18 barcode does not negate the requirement of the orderable GTIN barcode at the case level.

REQUIRED

- **SSCC-18 Barcode in GS1-128 Format w/ appropriate application identifier**

RECOMMENDED

- | | |
|---|--|
| <ul style="list-style-type: none"> • Ship From Address: Suppliers address, city, state, zip code • Ship To Address: Walmart DC address, city, state, zip code and Walmart DC Number (e.g. 6094) • Department number: (Walmart DEPT number, e.g., 00013) • Walmart Item number: (WMIT) | <ul style="list-style-type: none"> • Department number: (Walmart DEPT number, e.g., 00013) • PO type: (PO TYPE, e.g., 0020) • PO number: 10 digits (<i>ORDER #</i>) • Carrier name (if available) • BOL number (if available) • Pro number (if available) • # of cases on Pallet |
|---|--|

NOTE - 3rd party consolidators are required to submit an ASN with SSCC-18 barcode that will be used to identify each supplier PO and/or item that is included on the pallet.

NOTE - Specific networks may have additional pallet label requirements. Be sure to check with your network standards (e.g. DSDC, RX, etc.) for additional instruction.

Ship From: Any Vendor Any Address City, State, Zip	Ship To: Walmart RDC 0000G 5841 SW Regional Airport Blvd Bentonville, AR 72712		
CARRIER Carrier Name PRO: 1234567890 B/L 1234567890			
GDC# 0000	TYPE 0033	DEPT 00012	ORDER# 1234567890
WMIT: 001286123			
# of cases: (48 cases)			
 (00) 0 0614141 123456789 0			

Single SKU pallet label

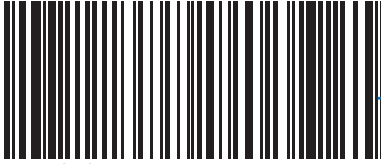
Ship From: Any Vendor Any Address City, State, Zip	Ship To: Walmart GDC 0000A - ASM DIS 5841 SW Regional Airport Blvd Bentonville, AR 72712		
CARRIER Carrier Name PRO: 1234567890 B/L 1234567890			
GDC# 0000	TYPE 0033	DEPT 00012	ORDER# 1234567890
WMIT: MIXED PALLET			
# of cases: (48 cases)			
MIXED PALLET			
 (00) 0 0614141 123456789 0			

Mixed pallet label

SSCC-18
barcode
(Required)

SSCC-18
barcode
(Required)

Pallet Shipping Labels – Pallet Pull / PDQ

Pallet Pull and PDQ Display Pallet Labels

A pallet label is **required** when shipping unitized items to the Walmart Distribution and Fulfillment Centers. Walmart does not provide a template for this label or require a specific format for this label. It is the Suppliers responsibility to create the label.

The SSCC-18 barcode is the **required** barcode format for all pallet labels. In addition to the SSCC-18 barcode, the 14-digit case (orderable) GTIN is **required** on the pallet label only when the item is a full Pallet Pull or PDQ Display.

- Pallet labels are **required** on at least 2 adjacent sides of the pallet, preferred on the upper right corner. It is best practice to place the label between layers of stretch wrap.



REQUIRED



- SSCC-18 Barcode in GS1-128 Format w/ appropriate application identifier**
- 14 Digit Supplier Pack (Orderable) GTIN Barcode:** ITF-14 and/or GS1-128 (w/appropriate application identifier) format

RECOMMENDED

- | | |
|---|---|
| <ul style="list-style-type: none"> Ship From Address: Suppliers address, city, state, zip code Ship To Address: Walmart DC address, city, state, zip code and Walmart DC Number (e.g. 6094) Department number: (Walmart DEPT number, e.g., 00013) Walmart Item number: (WMIT) | <ul style="list-style-type: none"> Department number: (Walmart DEPT number, e.g., 00013) PO type: (PO TYPE, e.g., 0020) PO number: 10 digits (ORDER #) Carrier name (if available) BOL number (if available) Pro number (if available) # of cases on Pallet |
|---|---|

Ship From: Any Vendor Any Address City, State, Zip	Ship To: Walmart GDC 0000A - ASM DIS 5841 SW Regional Airport Blvd Bentonville, AR 72712		
GDC# 0000	TYPE 0033	DEPT 00012	ORDER# 1234567890
WMIT: 001286123			
# of cases: (48 cases)			
 0 00 12345 67890 5			
PALLET PULL			
 (00) 0 0614141 123456789 0			

Pallet Pull pallet label

Ship From: Any Vendor Any Address City, State, Zip	Ship To: Walmart GDC 0000A - ASM DIS 5841 SW Regional Airport Blvd Bentonville, AR 72712		
GDC# 0000	TYPE 0033	DEPT 00012	ORDER# 1234567890
WMIT: 001286123			
# of cases: (48 cases)			
 (01)10847976000040(13)191120(10)ABC1234			
PDQ DISPLAY			
 (00) 0 0614141 123456789 0			

PDQ display pallet label

Pallet Placards

Pallet Placards

A pallet that **requires** a placard will also be **required** to meet the pallet label requirements. A placard is not a substitute for the pallet label.

The 14-digit case (orderable) GTIN is **required** to appear on the pallet label only when the item is a full pallet pull or PDQ display.

Items that **require** a pallet placard include:

- **PALLET PULL** - A palletized item that is shipped to store where the entire pallet is considered one case.
- **PDQ DISPLAY** - A pre-assembled display ready for the store floor.

- Program/Network Specific Items - Other items, such as shipments to the Grocery Consolidation Centers, annual event pallets, or MPP program pallets may **require** a specific placard in addition to these requirements. Follow additional requirements as needed.
- Placards must have bold lettering and be easy to identify as a pallet pull or PDQ display. These types of pallets are **required** to be labeled as shown below.
- **Required pallet placard size:** 8 1/2" x 11".
- When required, the pallet placard is **required** on all 4 sides of each pallet.

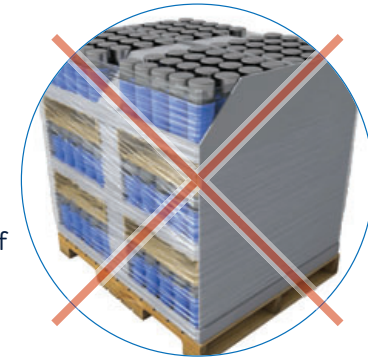

NOT ALLOWED
(no shroud)



Item and PO Configurations

Unitized Loading by Item and PO

To facilitate the effective and accurate receiving of your product, follow the guidelines below.

Multi-Item Pallet

- You are **required** to load each item completely by layer.
- You are **required** to ensure the information clearly differentiates each case and is easily identifiable on each case.
- Use tier sheets to each item.
- We recommend** using different font sizes and/or colors to help distinguish similar cases.

Example only

IN02000K34	IN01000K34
IN02003K34	IN01003K34

- Do not** mix layers by column stacking multiple items.
- Do not** place loose cases on top of the pallet.

Multi-PO Pallet (Same PO Type- Staple Stock or Assembly)

- You are **required** to load each PO completely by layer.
- You are **required** to label pallet as "Multi-PO."
- Use tier sheets to separate each PO.
- Do not** load staple stock and assembly POs on the same pallet.
- Do not** load POs for multiple DCs on the same pallet.
- Do not** place loose cases on top of the pallet.

NOTE - For Consolidation Centers, refer to the Consolidation Center Section. This instruction is not applicable for Consolidation Centers.

These instructions are not applicable for Direct Store Delivery. Refer to the Direct Store Delivery Section.

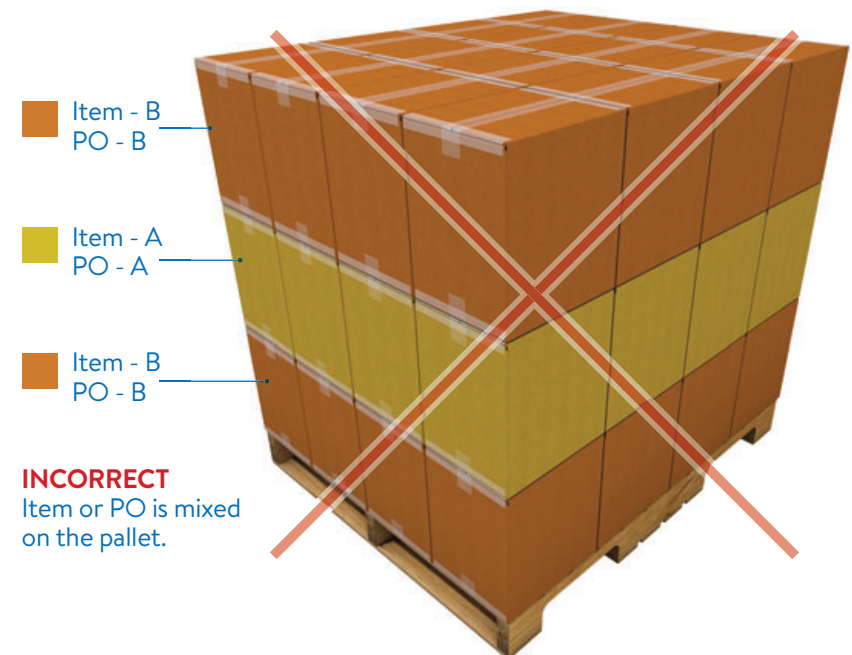
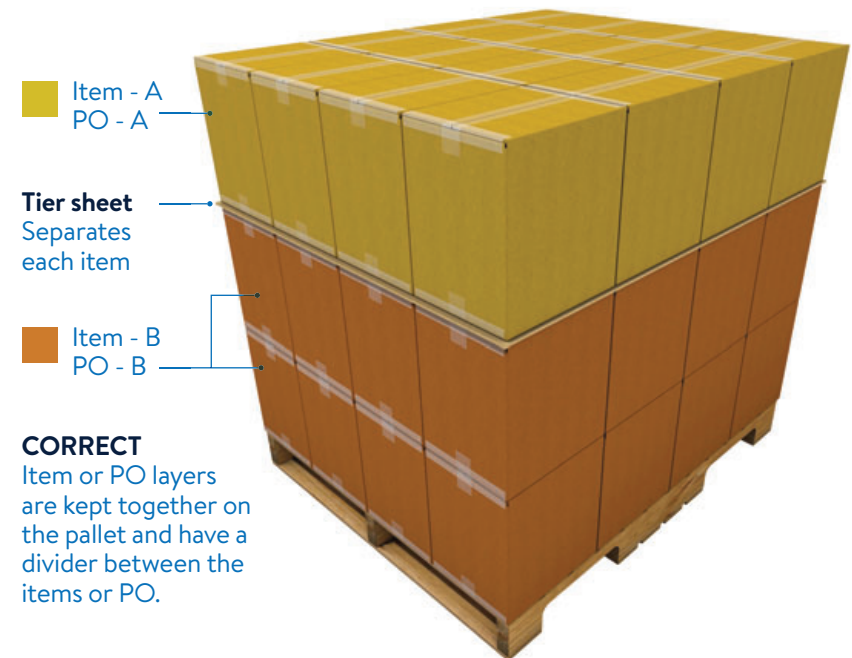

Pallet Standards

Minimum Grade A Stringer Pallet Standards

- **Full pallet 48" +/- .25 x 40" +/- .25"**
Partial four-way entry.
- **Half pallet 48" +/- .25 x 20" +/- .25"**
for approved programs only.
- **Quarter pallet 24" +/- .25 x 20" +/- .25"**
for approved programs only.
- Condition of the pallet is **required** to meet or exceed Grade A, 4-way, flush, and non-reversible specifications.
- Pallets are **required** to accommodate a standard pallet jack and/or forklift equipment with adequate top board spacing so forklift blades will not impact freight.
- Maximum spacing between each deck board is 4".
- Must be of sound material, free of knots.
- Pallets are **required** to have a minimum of 7 top boards and 5 bottom boards (*board minimum of 5/8" thick x 3.5" W +/- 1/8" tolerance to board thickness and widths shown.*)
- Pallets are **required** to have 3 stringers (*board minimum of 1.25" W x 3.5" H) +/- 1/8" tolerance to board thickness and widths shown.*)
- Oversized pallets are allowed only if the packaging size does not fit onto a standard 48" x 40" pallet without overhang. Oversized pallets must meet all other pallet requirements.

If only 1 dimension of your product is too large to fit on the standard 48" x 40" pallet footprint, you are allowed to grow the 40" width of the pallet to fit your product. The 48" standard pallet length and all other pallet quality standards are required to be maintained.

Odd-sized pallets are NOT ALLOWED when shipping through the Grocery Network. Product must ship on a standard 48" x 40" full pallet.

Pallet Standards

For domestic orders, the expected method of delivery into a Walmart DC is on a pallet. For direct import orders, refer to Direct Import Section of these standards. Product may be stored in a standard rack on a Supplier's pallet for an extended period of time. Pallets are **required** to support the weight of the product shipped on them.

© 2023 Walmart Stores, Inc. The examples shown are for reference only.

- Grade A pallet maximum loaded weight is 2,100 lbs.
- Block pallet maximum loaded weight is 2,800 lbs.
- Staple stock items are **required** to be palletized. All other items are preferred to be palletized.
- Pallets contaminated with items not shipped on that pallet (cross-contamination) or contaminated prior to being loaded for shipment are **NOT ALLOWED**.
- **Fees or charge-backs may be assessed if pallets fail to meet Walmart's pallet requirements.**

Alternative Pallet Materials

Walmart supports the use of alternative pallet materials such as plastic, metal, etc. Approval may require proof of structural capability and/or fire rating. All standard pallets must be edge rackable. Corrugated pallets are not acceptable to ship into the Walmart DCs.

The use of non-standard size or alternative material pallets must be approved by the Walmart Inbound Quality Senior Manager via logpkg@wal-mart.com.

Wood Packaging Materials (WPM)

Global standards for Wood Packaging Material (WPM) address the proper treatment requirements for WPM shipped into Walmart. This document can be found on Walmart Retail Link by following the path below. Walmart supports the ISPM 15 wood packaging material requirements. All regulated wood packaging material shipped into Walmart must be properly treated by heat treatment or methyl bromide fumigation.

2,4,6 tribromophenol (TBP) is banned in the United States, Europe, and Canada. TBP is not a registered pesticide with the Environmental Protection Agency (EPA). Therefore, it is not legal for sale or use in the United States. TBP is not a recognized wood preservative by the American Wood Protection Association (AWPA).

[Retail Link > Docs > W > Wood Packaging Material Requirements](#)



Full pallet (48" x 40")

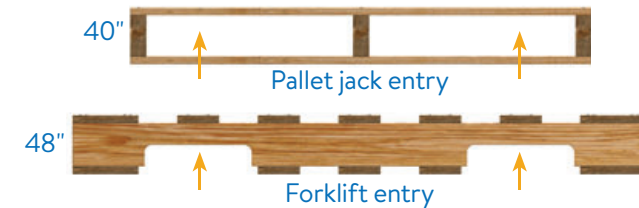

Half pallet (48" x 20")
(For approved programs only)



Quarter pallet (24" x 20")
(For approved programs only)

Pallet Standards, cont...

Stringer Wood Pallets Must Meet the Following Conditions:

- Unsecured or broken deck boards across the width of the pallet are **NOT ALLOWED**.
- Missing wood from leading edge boards greater than 1.5" diameter is **NOT ALLOWED**.
- Pallets with exposed nails outside the perimeter of the pallet are **NOT ALLOWED**.
- Raised nails greater than 1/8" on any surface of the pallet are **NOT ALLOWED**.
- Partial footings are **NOT ALLOWED**. Partial footings occur when 1/4 of the stringer board width or length that connects it to a bottom board has been removed or when securing nail shanks are exposed in the stringer.
- Tapered breaks with a depth of 1" along a 10" or greater run are **NOT ALLOWED**. (If at the 10" distance the depth is less than 1", the pallet is good. The pallet is unacceptable if the 1" depth runs the entire length of the board.)
- Stringers are preferred to be solid, unbroken, and without visible cracks on three sides longer than a 1" run. Weathering cracks that are not continuous and not visible from three sides are acceptable.
- Double stringers, patched boards, or metal repair plates are **NOT ALLOWED**.
- Pallets are not required to be bleached white but should be clean and odor free.
- Clean pallets are free of debris and stains, but discoloration due to aging is acceptable.
- Stapling, gluing, or taping PDQ displays or case layers to the pallet is **NOT ALLOWED**.
- Pallet restraining devices that penetrate trailer flooring are **NOT ALLOWED**.
- Pallets with broken, split wood and/or exposed nails are **NOT ALLOWED**. Missing or broken boards are **NOT ALLOWED**. Exposed splinters greater than 3" in length are **NOT ALLOWED**.



Cracks on the top or bottom boards greater than 1/8" W x 15" L are **NOT ALLOWED**.



Raised nails greater than 1/8" are **NOT ALLOWED**.



Double stringers, patched boards, or metal repair plates are **NOT ALLOWED**.

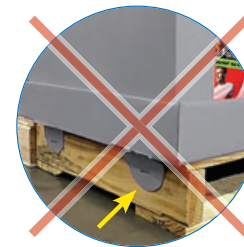

Stapling or gluing is **NOT ALLOWED**.



Pallet restraining devices that penetrate trailer flooring are **NOT ALLOWED**.

Pallet Standards, cont...

Minimum Unbranded, 9 Block Pallet Standards

- Full pallet 48" +/- .25" x 40" +/- .25" - Full four-way entry
- Hard and soft wood lumber is **required**. Plywood is **NOT ALLOWED**.
- Full perimeter bottom base is **required**.
- Must be of sound material, free of knots.

Top deck:

- Minimum 2 lead boards are **required** (40" +/- .25" L x 5.5" +/- .5" W x .5" D)
- Minimum 5 interior boards are **required** (40" +/- .25" L x 3.5" +/- .5" W x .5" D)
- Minimum 8 total top deck boards are **required**

Top stringer board:

- 3 boards are **required** (48" +/- .25" L x 3.5" +/- .5" W x 1.5" D)

Bottom perimeter deck:

- 2 lead boards are **required** (40" +/- .25" L x 5.5" +/- .5" W x .688" D)
- 3 interior boards are **required** (37" +/- .25" L x 3.5" +/- .5" W x .688" D)

Blocks:

- 3 center blocks are **required** (3.5" +/- .25" L x 3.5" +/- .25" W x 3.5" +/- .25" H)
- 6 outer blocks are **required** (7.5" +/- .25" L x 3.5" +/- .25" W x 3.5" +/- .25" H)

Pallet Poolers

Walmart Suppliers have the option of leasing a pooled pallet from any number of service providers or purchasing a one-way white wood pallet. Walmart does not endorse or recommend any specific pallet manufacturer or pooling service. All pallets must meet or exceed the Grade A specifications.

Approved pallet poolers:

www.chep.com | www.pecopallet.com | www.rm2.com | www.igps.net

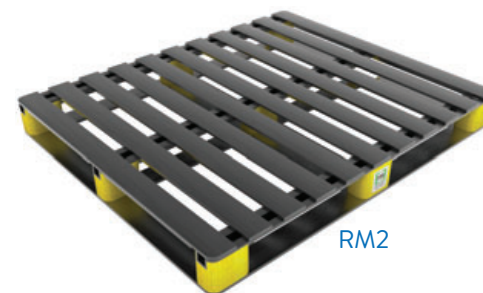

Pallet Standards, cont...

Block Wood Pallets Must Meet the Following Conditions:

- Pallets with exposed nails outside the perimeter are **NOT ALLOWED**.
- Raised nails greater than 1/8" on any surface of the pallet are **NOT ALLOWED**.
- Pallets missing greater than 1/3 of their blocks are **NOT ALLOWED**.
- Unsecured or broken deck boards across the width are **NOT ALLOWED**.

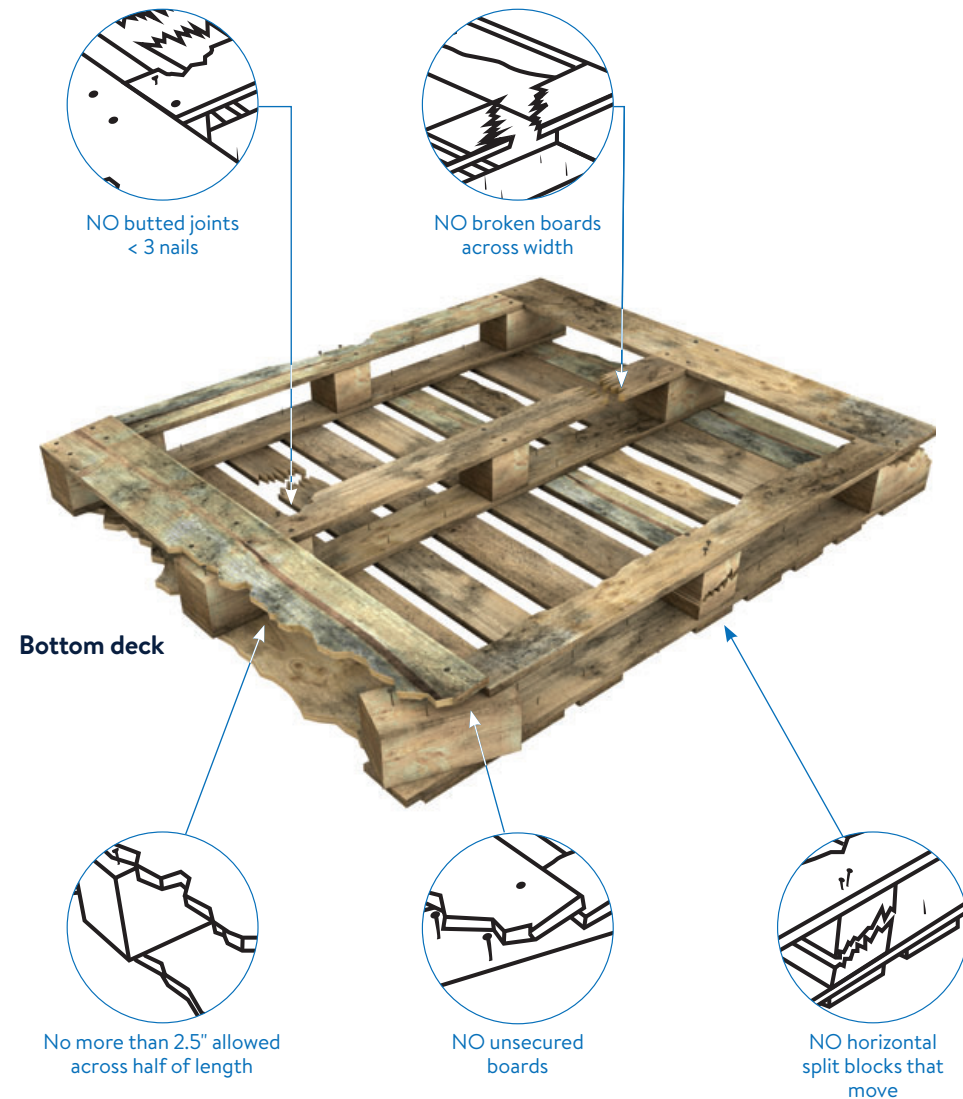
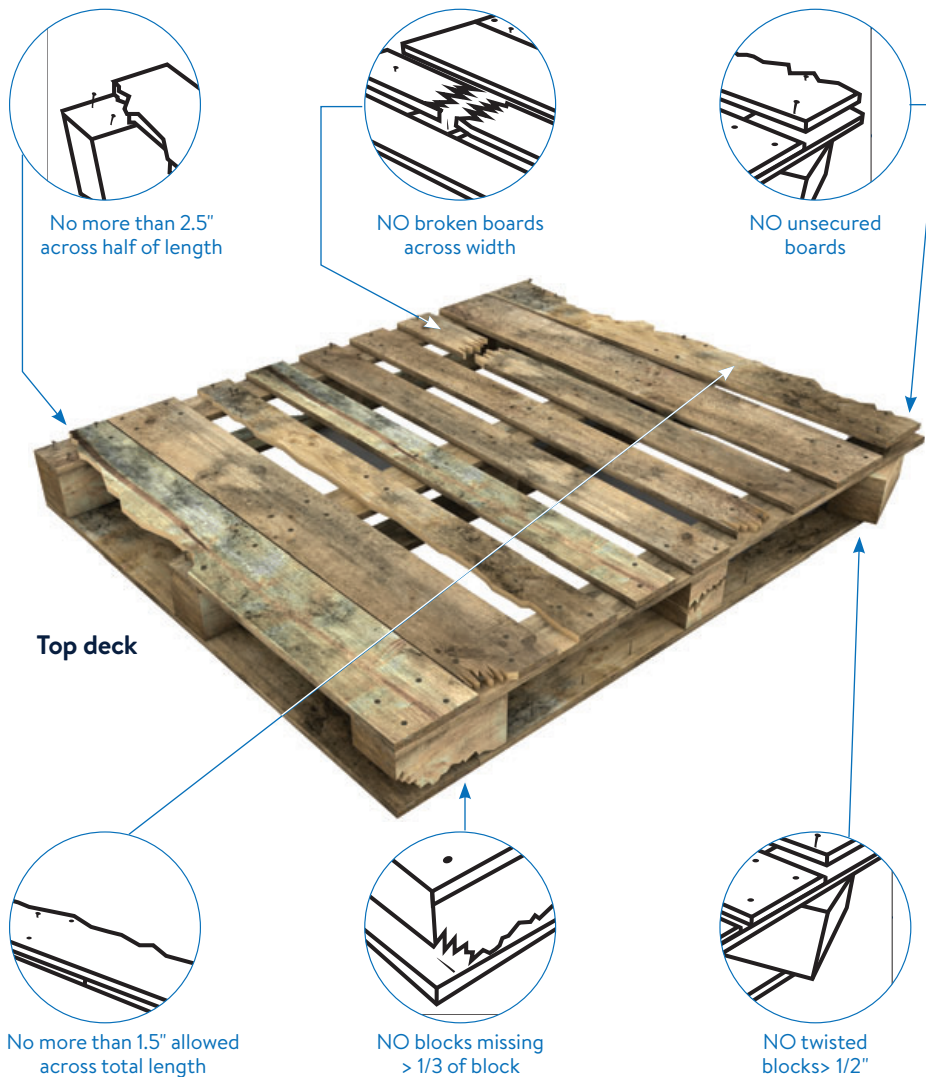

Slip Sheet Requirements

Slip Sheet Requirements

Unitized loads shipped on slip sheets to Walmart Distribution Centers are allowed only under the conditions below.

- Slip sheets can be used for certain approved items when trailer cube utilization is a significant factor. If the item weighs out before it cubes out on a trailer, a pallet is **required**.
- Slip sheets are **required** have 3" to 6" flaps.
- Slip sheet flaps are **NOT ALLOWED** to be wrapped under the pallet stretch wrap.
- Domestic slip sheet shipments **require** merchandise to be stacked on a 48" x 40" footprint with no overhang so the load can be placed on a 48" x 40" pallet and moved within the DC.
- The DCs will use slip sheet equipment to handle units that arrive on slip sheets. However, if the slip sheet is compromised or is of poor quality, be aware that clamping methods will then be used. These shipments will be subjected to side clamping forces that may expose the displays to damage not tested for during normal ISTA 3E testing protocols.
- Walmart **requires** the use of solid fiber slip sheets. Plastic slip sheets may be approved through the exception process by the Walmart Inbound Quality Senior Manager.

NOTE - The Walmart Inbound Quality Senior Manager for packaging must approve any products shipped on slip sheets prior to shipping at logpkg@wal-mart.com.

- Corrugated slip sheet is **NOT ALLOWED**. Solid Fiberboard is **required**.
- Slip sheet flaps are **required** to face outward from trailer or shipping container.
- Slip sheets that interlock with case are **NOT ALLOWED**.

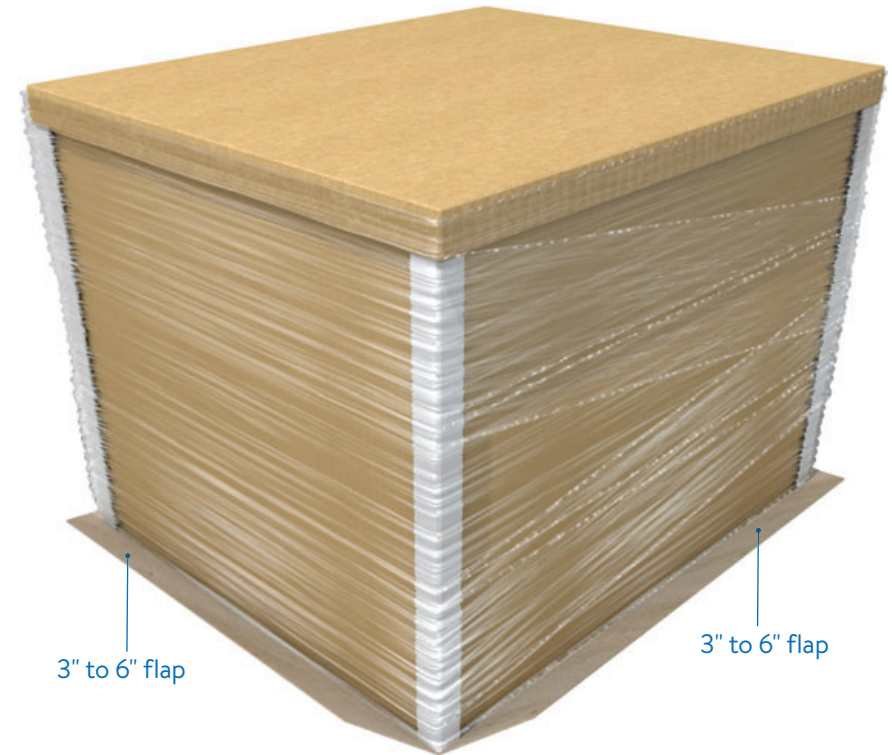

Single flap



Adjacent flaps

Preferred for domestic shipments



Opposite flaps

Preferred for import shipments



Four-sided flaps

Tier Sheet Requirements

Tier Sheet Requirements

Use of tier sheets on unitized loads is acceptable to help aid in pallet stability.

- Tier sheets and a hybrid stacking pattern can be used to help improve pallet stability. An example of a hybrid stacking pattern would be the two bottom layers column stacked and the top layer interlocked.
- Tier sheets are **required** to have no overhang and no less than 1/2" underhang.
- Tier sheets need to have a solid surface. Materials with holes or other perforations that extend through the thickness of the material are **NOT ALLOWED**.
- Tier sheets are **required** between each layer of unsupported shrink pack items unless the pallet is a full pallet pull.
- Tier sheets are **required** to be comprised of solid fiber or corrugated materials. Plastic tier sheets may be approved through the exception process by your Walmart Inbound Quality Senior Manager.

NOTE - The Walmart Inbound Quality Senior Manager for packaging must approve any alternative tier sheet materials prior to shipping at logpkg@wal-mart.com.

- Tier sheets that do not meet **required** specifications will not allow for automated depalletization of product.



Double Stacking - Inbound to Walmart

Unitized Stacking - Inbound

When stacking merchandise using pallets and slip sheets, refer to the following diagrams which illustrate proper heights and widths when shipping inbound on a dry trailer with swing doors.

- **NOTE - 96" is the maximum pallet height allowed when shipping to Walmart.**
- **85" is the maximum height when shipping a full pallet pull.**
- **Dept 4 Consumer Paper Goods allows maximum pallet height of 108", single or double stacked.**

Double Stacking

Pallets may be double stacked in the trailer, providing the weight and/or height permits double stacking without risk to packaging or product integrity.

ISTA 3E testing is highly recommended on all unitized pallets or product with slip sheets.



Double Stacking - Outbound from Walmart

Double Stacking - Outbound

- Walmart will ship double stacked pallets in a trailer from DCs to stores.
- Product will be double stacked, possibly with heavy product on the top of the stack.
- Labeling of a pallet with “DO NOT DOUBLE STACK” or any similar verbiage is **NOT ALLOWED**.
- Product must be designed to double stack. Even if your product weighs out a truck, it will be double stacked somewhere in the supply chain.

Lightweight Pallet

(Individual pallet configurations weighing **under 750 lbs.**)

The bottom layer of the pallet is **required** to support an additional **1,500 lbs.** without crushing, bending, or tearing the merchandise or packaging throughout the entire supply chain process.

Heavyweight Pallet

(Individual pallet configurations weighing **over 750 lbs.**)

The bottom layer of the pallet is **required** to support an additional **2,500 lbs.** without crushing, bending, or tearing the merchandise or packaging throughout the entire supply chain process.

Individual pallet load weight greater than 2,500 lbs., including pallet, is NOT ALLOWED.



Unitized Stacking

There are 2 main types of pallet stacking configurations. The pallet pattern chosen will depend on the individual tray/case design and material selection. Ship testing should be conducted to determine the most suitable pallet stacking pattern.

Creating layers that are not rectangular in shape, have gaps/holes in the center, or that are inconsistent in height across the layer are **NOT ALLOWED**. For shipments into any automated facilities, layers are **required** to be consistent. For instance, if you choose to use a tier sheet between any layers of your pallet, all layers will **require** the use of a tier sheet. For additional details and/or requirements, refer to other sections within Supply Chain Standards that may be applicable to where you are shipping your product.

- Staple stock items are **required** to be palletized. All other items are preferred to be palletized.

■ **NOTE** - Dept. 4 Suppliers only are not required to palletize staple stock items.



Column stacking

Column Stacking

- Column stacking is best for strength but is less stable than interlocking.
- Column stacking is the most common stacking pattern and is required for items that have a square footprint (ie. length = width).
- When stacking in columns, make sure that all boxes are properly aligned.
- If boxes are misaligned by as little as 1/2" (1.27 cm) in a three stack arrangement, stacking compression performance will drop by as much as 29%.
- Consider the use of tier sheets to help improve pallet stability when column stacking is used.
- Regardless of stacking configuration, unitized pallet loads must be able to be handled and remain stable without wrap or corner boards.



Tier sheet
between
case layers

Unitized Stacking, cont...

Interlock Stacking

- Interlocking pallet patterns are more stable than column stacking. Each layer is arranged in opposing directions and boxes do not align, resulting in reduced compression strength.
- The four corners of the container do not all align; three of the four sides rest on the side panel of the container below. This type of stacking results in a 45% to 55% loss in compression strength.



Interlock stacking

Hybrid Stacking

- Hybrid pallet patterns combine elements of both column stacking and interlock stacking patterns to gain the benefits that may be seen within both designs.
- A common type of hybrid stacking is called the 60/40 rule, where the bottom 60% of the pallet uses column stacking and the top 40% uses interlock stacking
- In the example below, we see a 90% increase in compression strength using a hybrid stacking pattern.
- Walmart recommends the use palletization software to analyze your pallet loads.
- Corrugated suppliers can often help with this analysis if you do not have in house capability for this.



Column Stacking -
Case size (13" x 6" x 10")

Hybrid stacking -
60/40 split example

Unitized Shipments

Unitized Bagged Products

Bagged products such as dog food, potting soil, and fertilizer are **required** to be layered on pallets with no overhang. These unitized loads are **required** to have separation between the product and the pallet. A 4" tall tray around the bottom two layers using a minimum of 200 lb. corrugated material is recommended. If it is not possible to use a tray, a slip sheet or tier sheet may be used as a barrier between the pallet and product. If the product is affected by moisture or high humidity, a moisture resistant material is **required**. Layers are **required** to be stacked using the interlocking method to provide stability.

Palletized Height and Loading

- When shipping merchandise on pallets, your first concern should be cubing out the trailer as long as the items can support the weight.
- For GM, dry grocery, and perishable products, the total pallet height is **NOT ALLOWED to exceed 96"** (single stack or double stack). Dept. 4 only is **NOT ALLOWED to exceed 108"** (single stack or double stack).
- Pallets are **required** to be unitized with the same case count per layer (TI) that matches the Pallet TI field in Walmart's Item File.
- When freight is ordered in full pallet quantity, the layers per pallet (HI) are **required** to match the Pallet HI field in Walmart's Item File.

Suppliers are **required** to properly block and brace all shipments to withstand the rigors of transportation from their ship point location to the DC. Cases are **required** to be secured to pallet with stretch wrap. Gluing or taping layers of cases together is **NOT ALLOWED**. Gluing or taping layers of cases to layers above or below on the unitized load is **NOT ALLOWED**. Gluing or taping layers of cases to pallet is **NOT ALLOWED**.

NOTE - When shipping into the eCommerce network, common slot sizes are 50", 70", and 108" in height. It may help to consider how your pallet height fits within these slots.

NOTE - Excess debris and dunnage on pallet is NOT ALLOWED.

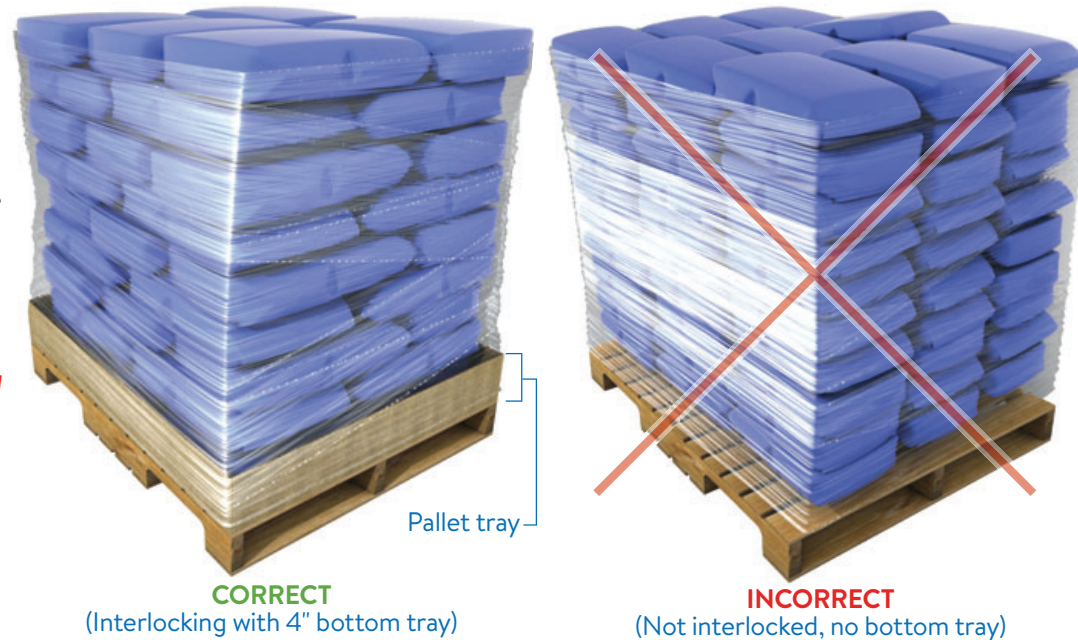

No overhang

Pallet Overhang and Underhang

Overhang and underhang can lead to damaged product and an underutilized trailer cube.

Pallet overhang - When merchandise is placed on pallets, ensure there is no freight overhanging the edge of the pallet. Merchandise is **required** to fit within a 48" x 40" pallet footprint. Pallet overhang is **NOT ALLOWED**.

Oversized pallets are allowed only if the packaging size does not fit onto a standard 48" x 40" pallet without overhang.

Overhang not to exceed 2" on any side of the pallet is allowed for Dept. 4 only.

Pallet underhang - Should be minimized to support the unitized load.

Unitized Shipments, cont...

Palletized Consistency Requirements

Pallets are required to ship to Walmart with consistent layer height, case orientation and in a configuration that matches the Ti-Hi that is published to Item 360 for your specific item. When developing a Ti-Hi, the use of a Chimney Gap, or other gaps in the pallet footprint, is **NOT ALLOWED**.

Produce items that require unrestricted airflow must be secured to pallet with ventilated stretch wrap and/or corner boards with plastic banding. The use of plastic banding for all other refrigerated/frozen products is **NOT ALLOWED**. Please review the Produce Shipments section of these standards for pallet building requirements for produce items.

Fiber Corner Boards

In order to increase recyclability, we strongly encourage the use of corner boards made of 100% plastic or 100% fiber. Mixed material corner boards such as composite or those with a metal or plastic interior and fiber exterior cannot be recycled from our DCs and stores.

- Can be unwrapped (natural fiber) or wrapped (white).
- Prefer no logos or other colors.
- Can be polycoated.
- Metal or composite materials are **NOT ALLOWED**.
- Gluing, taping, or any other method of fastening the corner boards to the pallet and/or cases is **NOT ALLOWED**.
- Suppliers have the responsibility to ensure length, width, and thickness of corner board is designed to properly protect and support the product.
- The use of corner boards on refrigerated/frozen products is **NOT ALLOWED**, with the exception of produce and fresh egg products. Please see the Produce Shipments and/or Egg Pallet Build sections of these standards for these items.

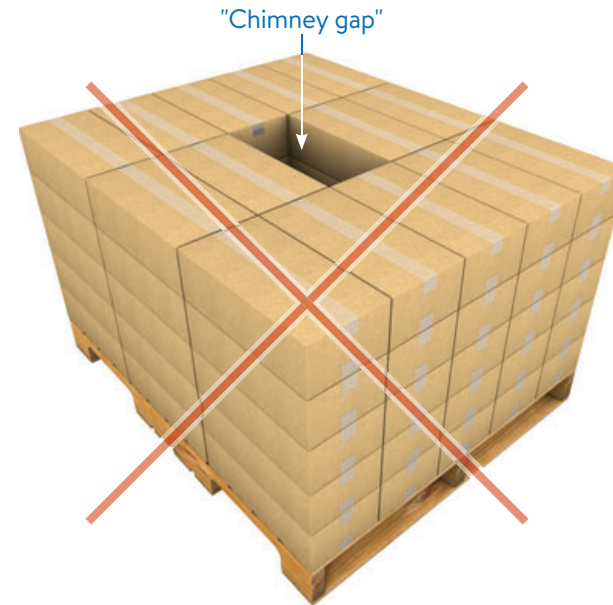

NOT ALLOWED
“Chimney gap” in the middle of the pallet prevents automated depalletization of your product.

PDQ Display – General Pack-Out

PDQ Display Pack-Out

- Do not stack heavy products on top of light products. Product must be stacked properly to avoid damages.
- Stacked product that is leaning or unstable on the pallet is **NOT ALLOWED**.
- Product cannot be configured on the pallet such that it falls over when moved with a forklift or when the stretch wrap is removed while in the DC racks.
- Edge protectors can be used for additional protection from banding as needed.
- A pallet shroud is **required** for palletized PDQ displays.
- The shroud height for a top cap style shroud is **required** to be the exact height from floor to the top of the display. Leaving air space between the display and shroud can cause collapse during shipment.
- Shrouds are **required** to withstand clamping up to a maximum of 2,500 psi. Direct imports are susceptible to pallet clamping.



- Stretch wrap is **required** to keep all display components secure during shipping.
- Plastic straps are **required** to secure display and shroud to pallet. Metal bands are **NOT ALLOWED**.
- Four fiber corner boards are **required** for additional double stacking strength. Corner boards can sit on top of the pallet or extend to the floor.
- Properly sized pallets are **required** to allow movement of the PDQ display throughout the DCs.

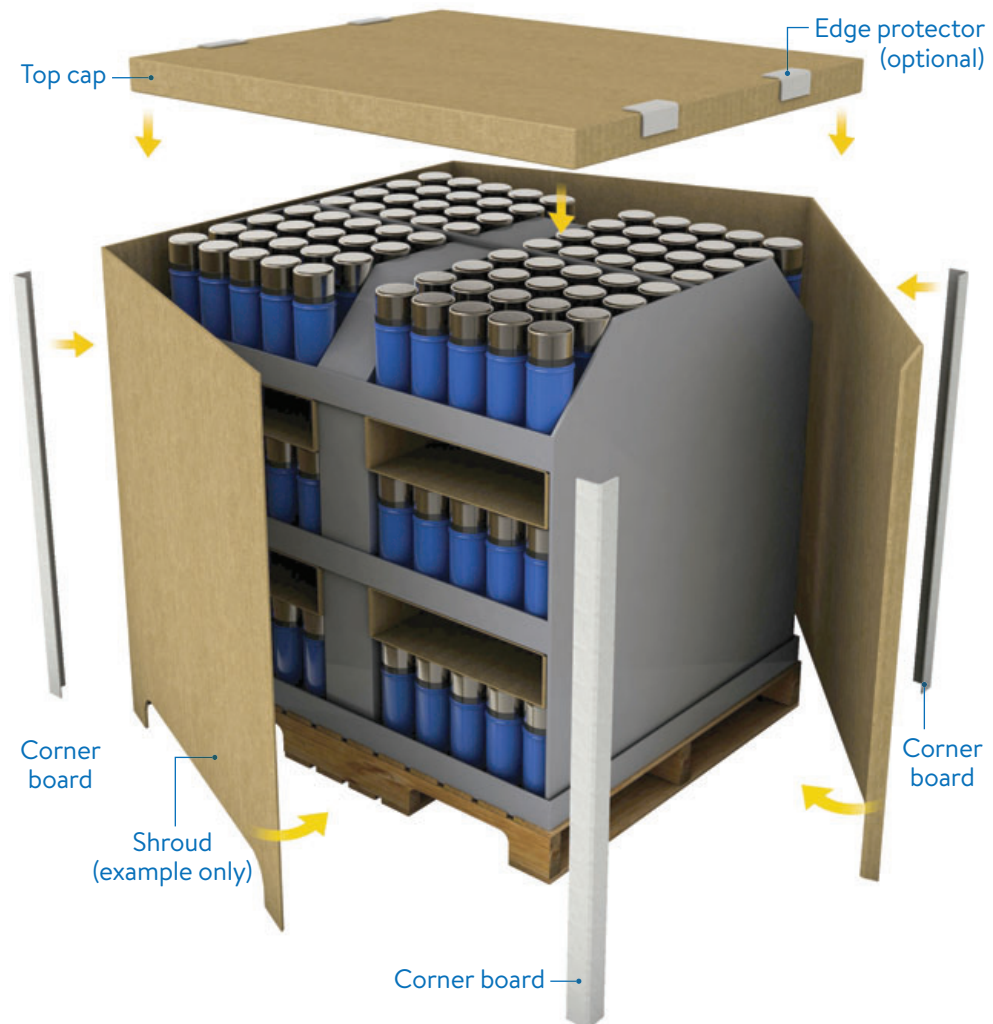

PDQ Display – Approved Shipping Shroud Types

PDQ Shrouds

- Standard pallet sized shrouds are **required** to be a 2-piece or 3-piece top cap shroud.
- Quarter pallet and half pallet displays may use the shroud style that works best for the intended display.
- Quarter pallet and half pallet displays are allowed for approved programs only.

Unacceptable shrouds



One-piece shroud with a flat top sheet. Does not have double stacking strength.

Acceptable shroud styles

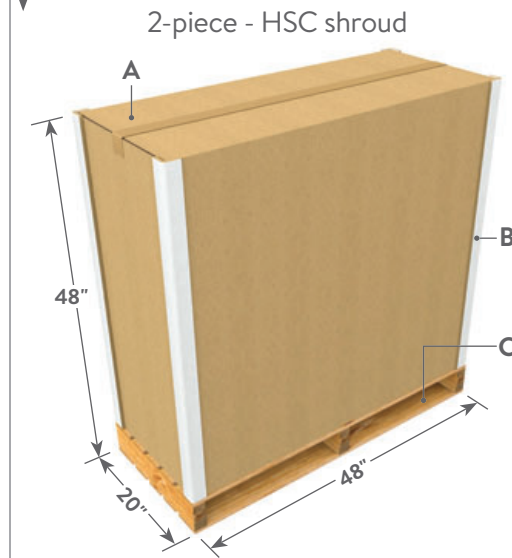

Constructed using 2 pieces, two side walls with taped top flaps.

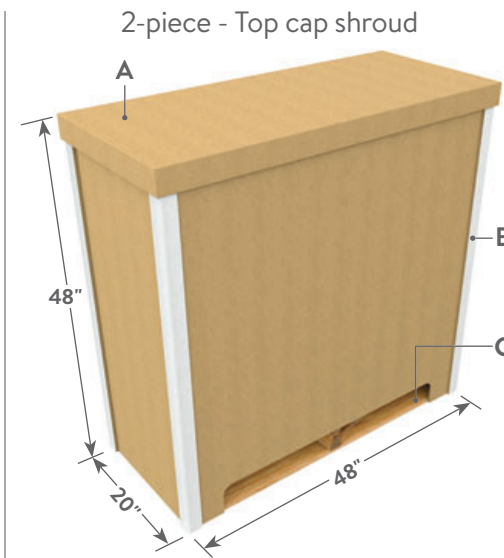
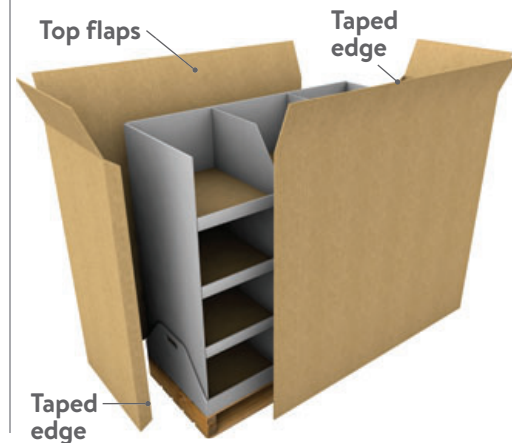

Constructed using 2 pieces, top cap and 1-piece wall.

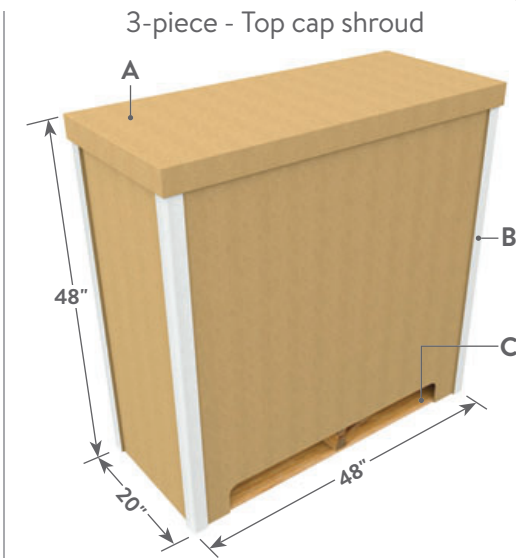
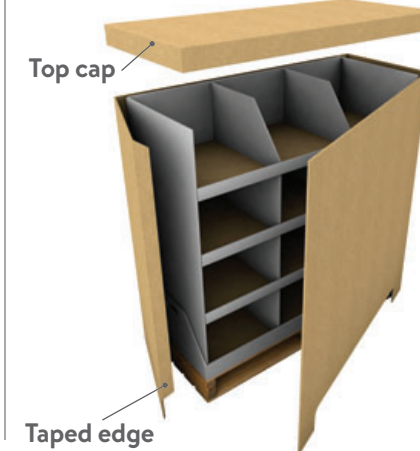

Constructed using 3 pieces, top cap, and 2-piece walls.

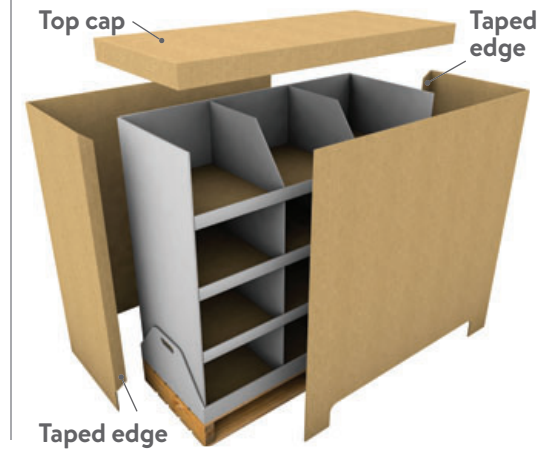

PDQ Display – Shipping Options

Fully Shrouded Displays Under 50 lbs. in Weight

- A fully shrouded display may ship on its own pallet or be combined onto a full size, standard 48" x 40" pallet. Strap the shrouded display, with its own corner boards applied to the front and back of the shroud, to the pallet.

Multiple Pallet Display

- Two half pallet or 4 quarter pallet fully shrouded displays may be shipped on a single standard 48" x 40" master pallet.
- Each display is **required** to be individually shrouded.
- A bottom cap is **required** to be used to allow easy removal from the master pallet at the DC.
- Each shrouded display is **required** to be individually labeled.
- Each individual display is **required** to have four corner boards applied.
- Each individual display is **required** to have a minimum of two plastic straps to secure the shroud to the top and bottom caps of the display.
- Individual displays are **required** to be placed on the master pallet, stretch-wrapped together, then strapped to the master pallet.
- A "Master Pallet" placard is **required** to be placed on the outside of the stretch wrap on all four sides of the pallet.
- Quarter pallet and half pallet displays may be placed on a wooden quarter pallet or half pallet before being placed on a standard 48" x 40" pallet only if the total palletized height is 48" or less.

Fully Shrouded Displays over 50 lbs. in Weight

- A fully shrouded half pallet or quarter pallet display over 50 lbs. in weight is **required** to ship on its own pallet.
- Stacking 2 half pallet or 4 quarter pallet displays next to each other on a master 48" x 40" pallet is **NOT ALLOWED** if the total height of the displays and pallet is over 48" in height.
- No bottom cap is required for the display when it is strapped to an individual pallet.

NOTE - Quarter pallet and half pallet displays are allowed for approved programs only.

NOTE - When displays are separated at the DC, they may be laid on their sides as they are loaded onto trailers. If the display must remain upright to prevent damage, it is required to ship on its own pallet and be marked with "This side up" and appropriate directional arrows.



Master Pallet Placard



Master Pallet Placard



Stretch Wrap

Stretch Wrapping

Merchandise placed on pallets or slip sheets is **required** to be stretch-wrapped to contain and prevent damage during shipping. Stretch wrap specifications are based on the containment force requirements outlined below.

- When stretch wrap equipment is unavailable, stretch wrap must be top quality and a minimum of 80 gauge, 15" wrap.
- Wrap from the bottom of the pallet upwards in an overlapping pattern.
- Ensure the bottom layer is double wrapped. Double wrap while overlapping every 2-4 inches. Covering pallet fork entry holes with stretch wrap is **NOT ALLOWED**.
- Pallet labels may be secured between or on the outside of stretch wrap layers.
- Colored stretch wrap is **NOT ALLOWED**. Exceptions may be given to support special events. Black corrugated or black stretch wrap is **NOT ALLOWED**.
- Netting and twine for pallet containment is **NOT ALLOWED**.
- Using more than 10 layers of stretch wrap is **NOT ALLOWED**.
- Stretch wrap tails are **NOT ALLOWED**. The end of the stretch wrap is **required** to be pressed firmly against the unit load.
- Ventilated stretch wrap is allowed as needed for product.
- Cases are **required** to be secured to the pallet with stretch wrap.

Containment Force

- Containment force is the amount of force the wrap exerts on a load in order to hold it together for the duration of the shipping process.
- Containment force is the only consistent measurement that can be taken regardless of the gauge of wrap, manufacturer of wrap, or wrapping method (type of equipment used vs. hand application).
- This is the most important measurement to monitor when down-gauging or converting to or qualifying new wraps. The containment force is **required** to be held to a consistent number, appropriate for the load, in order to ensure that the product is delivered to its destination in good condition.

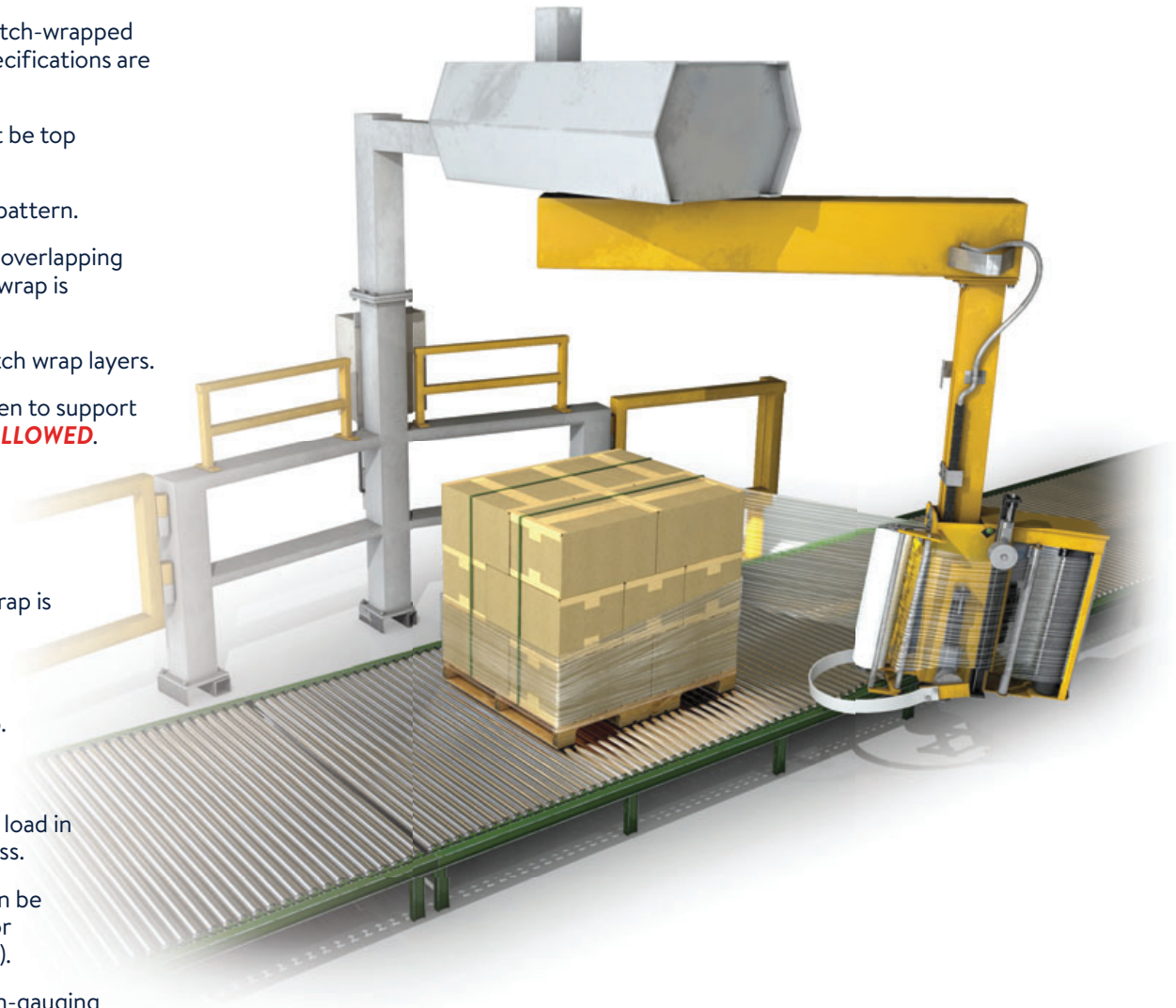

Trailer Loading

PO Trailer Separation

All pallets that belong to the same PO must be kept together throughout the trailer. Always load staple stock purchase orders items in the nose of the trailer and Distribution Assembly (DA) purchase orders items on the tail of the trailer. Overweight axle concerns may prevent some pallets from being separated by PO. It is the responsibility of the Supplier to ensure that trailer is loaded in compliance with DOT regulations.

All PO types are required to be separated on the trailer with truckload shipments. PO types cannot be mixed within the trailer or on the same pallet.

PO pallet trailer configuration (colors represent different POs)

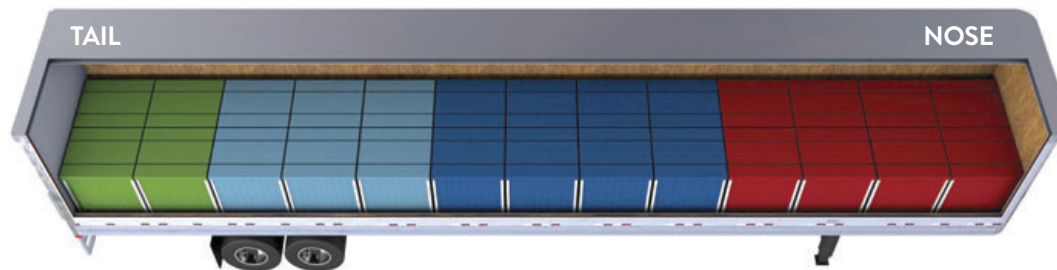

CORRECT
Pallets of the same PO/items are kept together in the trailer.



INCORRECT
Pallets of the same PO/items are mixed throughout the trailer.

Item Trailer Separation

All pallets of the same item, PO, and PO Type are **required** to be kept together throughout the trailer. Overweight axle concerns may prevent some pallets from being separated by item. It is the responsibility of the Supplier to ensure that trailer is loaded in compliance with DOT regulations.

PO separation is 1st priority, item separation is 2nd priority.

DSV Suppliers see the DSV section for specific BOL requirements for your shipments.

Item pallet trailer configuration (colors represent different POs)

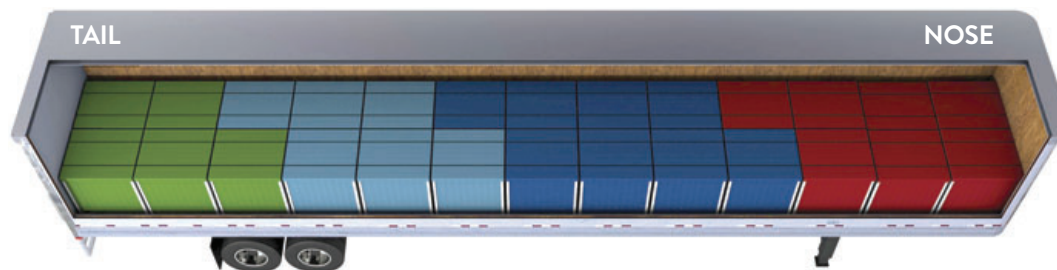

CORRECT
Pallets of the same PO/items are kept together in the trailer.



INCORRECT
Pallets of the same PO/items are mixed throughout the trailer.

Trailer Measurements

53 ft. swing door dry van 636" L x 102" W x 110" H	53 ft. rollup door dry van 636" L x 102" W x 108" H	48 ft. rollup door 576" L x 99" W x 108" H	53 ft. swing door reefer 636" L x 102" W x 110" H (up to 3 reefer units)	53 ft. rollup door reefer 636" L x 102" W x 108" H (up to 3 reefer units)
Max loadable internal space 630" L x 96" W x 104" H	Max loadable internal space 626" L x 96" W x 98" H	Max loadable internal space 566" L x 93" W x 98" H	Max loadable internal space 628" L x 96" W x 104" H	Max loadable internal space 624" L x 96" W x 98" H
Floor stacked - 3,640 cubes	Floor stacked - 3,408 cubes	Floor stacked - 2,985 cubes	Floor stacked - 3,608 cubes	Floor stacked - 3,377 cubes
Straight	Straight	Straight	Straight	Straight
Single stacked - 26 pallets Double stacked - 52 pallets	Single stacked - 26 pallets Double stacked - 46 pallets	Single stacked - 22 pallets Double stacked - 38 pallets	Single stacked - 26 pallets Double Stacked - 49 pallets	Single stacked - 26 pallets Double Stacked - 43 pallets
Pinwheel	Pinwheel	Pinwheel	Pinwheel	Pinwheel
Single stacked - 28 pallets Double stacked - 56 pallets	Single stacked - 28 pallets Double stacked - 50 pallets	Single stacked - 24 pallets Double stacked - 42 pallets	Single stacked - 28 pallets Double stacked - 53 pallets	Single stacked - 28 pallets Double stacked - 47 pallets
48" wide load	48" wide load	48" wide load		
Single stacked - 30 pallets Double stacked - 60 pallets	Single stacked - 30 pallets Double stacked - 54 pallets	Single stacked - 26 pallets Double stacked - 46 pallets		
				
96" maximum height	96" maximum height	96" maximum height	96" maximum height	96" maximum height

Trailer Load Patterns

Use one of the suggested loading patterns to reduce air space and freight damage.

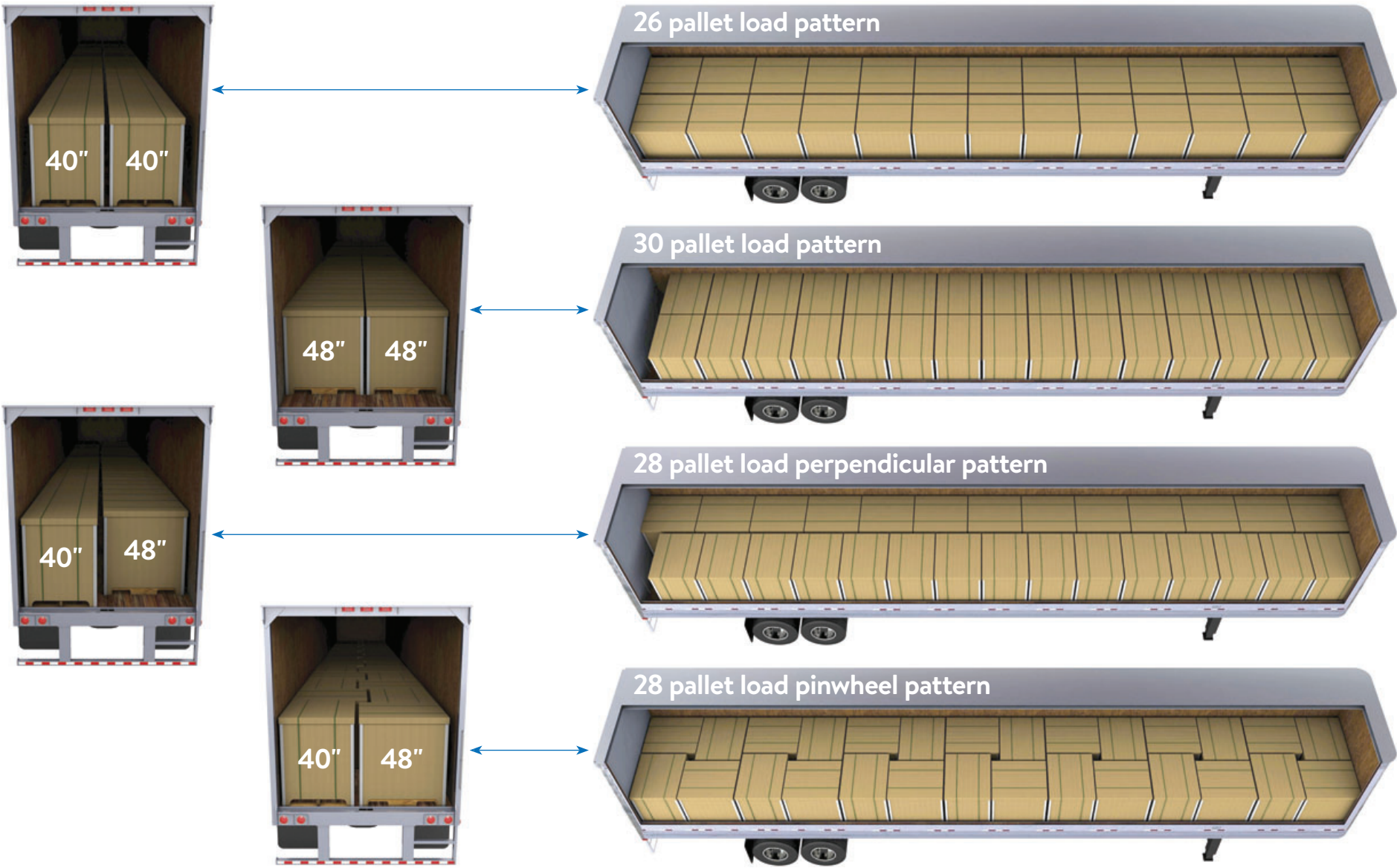

Packing Slips and Global Location Number (GLN)

Packing Slip

A packing slip is **required** for use:

- LTL shipments - If shipping LTL, a packing slip is **required** to be attached to the outside of one case for each purchase order.
- Full Truckload shipments to the eCommerce Fulfillment Centers and the Grocery Distribution Centers.
 - **Required** to be attached to the outside of the last box loaded on the trailer.
 - **Required** to face outward on the pallet or box in clear view of the unloader.
- A second packing slip is **required** to be made available to the carrier with the BOL and the freight bill for presentation at the warehouse transportation office.

A packing slip is **not required** for use:

- Full Truckload shipments to the Regional and Fashion Distribution Centers.
- Small parcel shipments.

The following information is **required** on packing slips:

- PO number
- PO type number
- Location number (store or DC number)
- Department number
- Shipper's name and address
- Supplier stock number and/or Walmart item number
- Case count per item
- Total case count shipped

Guidelines for GLN Address Information

The following Ship To addresses will be used for all US and Canada PO shipments to Walmart DCs. The cross-reference table to the right identifies the Walmart PO type associated with the actual delivery address that must be used on all BOLs and shipping labels.

Address information is available via EDI (816) or Walmart Retail Link. For EDI updates, contact the Help Desk at 479-273-8888.
Retail Link > Tools > Store/Club/DC & GLN Lists

DC GLN ADDRESS / PO TYPE CROSS-REFERENCE							
GLN SEQ	DC	GLN	Address Line 1	Address Line 2	City	State	Zip
1	6094	0078742035222	WAL-MART DC 6094R-REGULAR	5821 SW REGIONAL AIRPORT BLVD	BENTONVILLE	AR	72712
2	6094	0078742035239	WAL-MART DC 6094C-GENERAL	5821 SW REGIONAL AIRPORT BLVD	BENTONVILLE	AR	72712
3	6094	0078742035246	WAL-MART DC 6094T-TAB	5821 SW REGIONAL AIRPORT BLVD	BENTONVILLE	AR	72712
4	6094	0078742035253	WAL-MART DC 6094D-DSDC	5821 SW REGIONAL AIRPORT BLVD	BENTONVILLE	AR	72712
5	6094	0078742035260	WAL-MART DC 6094J-JIT	5821 SW REGIONAL AIRPORT BLVD	BENTONVILLE	AR	72712
6	6094	0078742035277	WAL-MART DC 6094P-PAD	5821 SW REGIONAL AIRPORT BLVD	BENTONVILLE	AR	72712
7	6094	0078742035284	WAL-MART DC 6094W-WPM	5821 SW REGIONAL AIRPORT BLVD	BENTONVILLE	AR	72712
8	6094	0078742035291	WAL-MART DC 6094I-IMP ASM	5821 SW REGIONAL AIRPORT BLVD	BENTONVILLE	AR	72712
9	6094	0078742035307	WAL-MART DC 6094A-ASM DIS	5821 SW REGIONAL AIRPORT BLVD	BENTONVILLE	AR	72712

EXAMPLE: GLN DC ADDRESS CROSS-REFERENCE							
GLN SEQ	DC Nbr	GLN	Address Line 1	Address Line 2	City	State	Zip
1	6094	0078742035222	WAL-MART DC 6094R-REGULAR	5821 SW REGIONAL AIRPORT BLVD	BENTONVILLE	AR	72712
2	6094	0078742035239	WAL-MART DC 6094C-GENERAL	5821 SW REGIONAL AIRPORT BLVD	BENTONVILLE	AR	72712
3	6094	0078742035246	WAL-MART DC 6094T-TAB	5821 SW REGIONAL AIRPORT BLVD	BENTONVILLE	AR	72712
4	6094	0078742035253	WAL-MART DC 6094D-DSDC	5821 SW REGIONAL AIRPORT BLVD	BENTONVILLE	AR	72712
5	6094	0078742035260	WAL-MART DC 6094J-JIT	5821 SW REGIONAL AIRPORT BLVD	BENTONVILLE	AR	72712
6	6094	0078742035277	WAL-MART DC 6094P-PAD	5821 SW REGIONAL AIRPORT BLVD	BENTONVILLE	AR	72712
7	6094	0078742035284	WAL-MART DC 6094W-WPM	5821 SW REGIONAL AIRPORT BLVD	BENTONVILLE	AR	72712
8	6094	0078742035291	WAL-MART DC 6094I-IMP ASM	5821 SW REGIONAL AIRPORT BLVD	BENTONVILLE	AR	72712
9	6094	0078742035307	WAL-MART DC 6094A-ASM DIS	5821 SW REGIONAL AIRPORT BLVD	BENTONVILLE	AR	72712



Packing slip (example only)

Bill of Lading (BOL)

BOL Requirements

A separate BOL is **required** to be filled out for each delivery address (GLN Address Line 2). All PO numbers are **required** to be listed on the BOL with the appropriate location number (DC number), PO type, and department number, with total cases by PO. Use supplemental pages for additional PO if needed. In order to eliminate any delays in timely processing, proper delivery, and segregation of these shipments, the GLN address information is **required** to be used on the Ship To Address.

For LTL shipments, multiple PO types shipped from the same origin ship point to the same DC on the same day can be listed on the same BOL.

The Ship To address used should be Walmart DC 60XXG-GENERAL.

The BOL must show the proper classification description as stated in the National Motor Freight Classification tariff and list all POs being shipped and the number of cases for each PO.

When carrier drivers sign a BOL, they are signing for a specific number of shipping units (cases, floor load pieces, or pallets), not single selling units. You must record the quantity of shipping units and all PO numbers on the BOL. If the shipment is palletized, drivers are to sign for the number of pallets, not the number of cases or pieces.

Handwritten corrections on the BOL are NOT ALLOWED.

POs for the same Walmart DC address should be shipped on one BOL. At many Walmart facilities, distribution and staple stock POs have different addresses. Freight delivered to one of these split-address locations must be shipped on separate BOLs. If there are multiple POs on a truckload shipment, each PO must be loaded separately. A master BOL must be used when shipping to a Walmart center point or consolidator.

- The BOL must have the carrier name and pro number. If a trailer number is available, include it on the BOL. If Walmart is to pay freight charges, the BOL must be marked "Collect."
- If a Walmart load number is available, it must be on the BOL in the SID field.
- The Must Arrive By Date (MABD) should be specified on the BOL (Must Deliver By Date) field so that the carrier clearly understands the delivery date expectation.
- For BOLs that have multiple POs and different MABDs, the earliest MABD should be specified.

Walmart eCommerce makes use of multiple 3PL providers within its fulfillment center network. All 3PL fulfillment centers within the Walmart.com network have a Walmart store number that will be included on all routing instructions for collect freight to these FCs. When filling out bills of lading for loads going to these facilities, vendors should fill out the consignee field on the BOL to match the destination as it appears on the routing instructions received from Walmart.com.

© 2023 Walmart Stores, Inc. The examples shown are for reference only.

For collect shipments, failure to indicate correct consignee name and address, freight terms, Walmart load number, and PO numbers may result in chargebacks to the Supplier.

VICS BOL Example

Our long-term strategy is to support implementation of the VICS Standard BOL. For more information go to www.gs1us.org.

BOL Required Information

- Ship from address
- Ship to address
- Consignee ID # (CID) - Imports Only
- BOL number
- Payment terms for freight charges
- Check box when using master BOL
- 10-digit PO number
- Number of Cases
- Weight of Cases
- 4-digit PO type
- 5-digit department number
- Indicate if product is unitized (pallets or slips)
- 5-digit destination number (WM facility number)
- Trailer seal number
- Unit and commodity information
- General description of the product
- National Motor Freight Classification item number
- NMFC freight class
- Shipper's signature protecting consignee default
- Carrier's signature indicating receipt of product listed on BOL on specified date
- Select party that counted freight
- Select party that loaded freight
- Shipper's signature indicating BOL accuracy
- Must Arrive By Date (MABD = Expected DC delivery/arrival date)
- Set Temperature for temperature-controlled trailers

BOL Optional Information

- Shipment ID # (SID # - Walmart load # if available)
- Carrier information numbers: Trailer, SCAC, and Pro
- Provide any additional details or comments.

DSV suppliers see the DSV section for specific BOL requirements for your shipments.

SHIPMENT	PO	UNIT	WEIGHT	TYPE	CLASS	FR	TO	DATE	QTY	WT	PKGS	UNIT	
1	00111111	30	100	10	1000	0001	0001	0001	1	100	1	1	
2	00111111	30	100	10	1000	0001	0001	0001	1	100	1	1	
3	00111111	30	100	10	1000	0001	0001	0001	1	100	1	1	
4	00111111	30	100	10	1000	0001	0001	0001	1	100	1	1	
5	00111111	30	100	10	1000	0001	0001	0001	1	100	1	1	
GRAND TOTAL										500	5000	5	5

Advanced Ship Notice (ASN)

ASN is the Electronic Data Interchange (EDI 856) notification used to inform Walmart about the contents of a shipment prior to delivery.

ASN Benefits

For Walmart

- Better labor planning for advanced visibility to incoming freight.
- Improved receiving efficiencies with fewer freight problems to reconcile.
- Better inventory management.
- Reduced manual processing.
- Source traceability of recalled products.

For Supplier

- Improved invoicing accuracy and quicker payment, leading to faster turnaround of trailers.
- Better OTIF performance.
- Reduced manual processing and paperwork.
- Auto PO Update – Reduction in manual PO change forms reviewed/processed and quicker re-ordering of shorted goods to drive in-stock.

ASN Onboarding

Pre-onboarding requirements

- Valid Walmart Retail Link ID must be connected to the Supplier number being onboarded.
- Validate GTINs and ensure data is current and synchronized between Supplier and Walmart item file.
- Review Walmart ASN specifications document and complete mapping of data elements from your current system.

Onboarding

- Complete 856 and 824 testing in Vendor Self-Test Portal.
- Reach out to EDI or ASN onboarding team to move the TP from testing into production.
- Send ASN for active PO and follow response on the EDI 997 Functional Acknowledgments and EDI 824 Application Advice.
- Review and correct possible errors.
- Contact EDI Helpdesk or ASN Onboarding Team with questions.
- Transmit ASNs for all sequences and departments shipping to the DC.

Supplier Resources

EDI support

- For questions, contact EDI Supplier Support at **479-273-8888**.
- Open a ticket under the Supplier self service app on Retail Link.
- For Produce Traceability Initiative (PTI) questions, reference www.producetraceability.org

EDI 856 specification:

[Retail Link > Apps > E > EDI-B2B](#)

Inbound Appointment Scheduling

All inbound product deliveries made to a Distribution Center should have a scheduled delivery/appointment. The DC Appointment Scheduler application is a web-based application used by Suppliers, carriers, and DC associates for managing inbound deliveries. The scheduler application allows users to view and modify delivery appointments based on each user's profile.

Appointment Compliance

All Suppliers are expected to meet our appointment compliance requirements. Maintaining high appointment compliance has mutual benefit for Walmart, Suppliers, and Carriers, including:

- Better labor planning through advanced visibility to incoming freight.
- Improved gate-in and receiving efficiencies.
- Reduced manual processing, paperwork, and rework.
- Improved inbound capacity and availability.

Appointment Compliance Expectations

Appointment Accuracy

The following information is **required** to be updated and accurate in DC Scheduler prior to the load's arrival at the DC:

- SCAC (Standard Carrier Alpha Code) - The appointment is **required** to have a valid SCAC that matches the carrier that will be delivering the load.
- POs Numbers on the Load - All POs delivered on the load are **required** to be included on the appointment with valid Walmart PO numbers.
- Case Count - The appointment is **required** to reflect the correct number of cases on the load by PO.

Appointment On-Time

- Loads are **required** to gate in on-time per the scheduled appointment.
- A delivery is **required** to be rescheduled prior to the appointment time if there is a known delay.

Supplier and Carrier Resources

Scheduler Support - For questions regarding DC Scheduler functionality or system issues, contact dcschadm@wal-mart.com.

DC Scheduler Training and User Guides - [Retail Link > Academy > Ordering & Replenishment > Scheduling DC Appointments > DC Appointment Scheduler](#)

Additional Resources and Guidance - [Retail Link > Academy > Ordering & Replenishment > Scheduling DC Appointments > Inbound DC Scheduling](#)





Product Packaging

Certain product types **require** additional packaging standards to help ensure as damage-free a transit as possible.

Tabletop Packaging

- Handling warnings such as **Fragile, Handle With Care, No Clamp**, and stacking limits must be printed on the shipping case.
- Up Arrows are **required** to indicate stacking and handling directions.
- Cases containing individual dishware are **required** to be constructed with a burst strength that allows a 5-foot stack height.



Furniture Packaging

- Arrows indicating stacking and handling directions are **required** to be printed directly on the shipping case.
- Handling warnings such as **Team Lift** are **required** to be printed on the case.
- When products are packed in multiple cases, each case is **required** to indicate Box 1 of 2, Box 2 of 2, and so forth.
- The case is **required** to be constructed with a burst strength that allows a 5-foot stack height in the warehouse.



Large TVs, All-in-One Computers, and Monitors Packaging

Due to their very fragile nature, large electronics such as computers, TVs, and monitors **require** special packaging to ensure safe transit through the transportation network.

- We strongly recommend double-boxing all large electronics by placing the manufacturer's box in another, slightly larger box.
- UP Arrows indicating stacking and handling directions are **required** to be printed on the shipping case.
- Large-screen TVs **require** 3 sets of UPC-S/N labels. One set to be located on the short side, one set on the large side, and one set on the top to meet in-store requirements.
- Large-screen TVs are **required** to ship on a pallet sized appropriately to accommodate them with no overhang and no more than 1" of underhang. The pallet size must maintain the build style of a standard, 4-way Grade A 48" x 40" pallet. The 48" length is **required**. The 40" width is allowed to grow as needed to accommodate the TV packaging.
- Large-screen TVs are **required** to pass a Walmart-specific TV test protocol. Suppliers can obtain a copy of the **required** test protocol on [Retail Link > Academy > Ordering & Replenishment > Shipping, Routing, Packaging, Labeling > Transit Testing](#).





Fragile Product Packaging

Fragile Merchandise Packaging

Glass, ceramic, and fragile items are **required** to be properly packaged to minimize the risk of damage throughout the supply chain. Cases may encounter heavy compression and vibration during transportation and on a DC conveyor and automation system.

Packaging Requirements

- See the following page for tray specifications for glass or ceramic bottles/jars shipped in trays.
- Plastic film is **required** to fit tightly around the tray to minimize movement.
- Pack dimensions with an aspect ratio (height/width) greater than 1.6 are **required** to ship in a full-corrugated case and will be automation ineligible.
- All cases containing fragile merchandise are **required** to be clearly marked with a graphic icon depicting the fragility of the merchandise.

Protective Packaging Options

- Corrugated dividers or partitions are strongly preferred to eliminate glass-on-glass contact and prevent breakage.
- Use of protective coating on the glass container or bottle is preferred.
- Padding on the bottom of the case must be sufficient to protect against bottom tray wear during conveyance.

Ship Testing

Suppliers are **required** to conduct a Food & Consumable 3A ship test for multi packs of glass or ceramic bottles and jars to ensure adequate packaging protection.

- Suppliers can obtain a copy of the **required** test protocol on [Retail Link > Academy > Ordering & Replenishment > Shipping, Routing, Packaging, Labeling > Transit Testing](#).
- Send a copy of your passing ISTA ship test to ISTAtesting@wal-mart.com.
- The test above must be conducted before requesting a test shipment through the Walmart DC.

Do not over pack or reinforce packaging during your ship test. Ship exactly how you intend to ship to the Walmart DC.

Sustainability goals should not compromise the packaging needed to protect the product throughout the supply chain.

NOTE - Glass packaging shipping through the eCommerce network must pass eCommerce shipping standards. See General Requirements for more detail.





Fragile Product Packaging , cont...

Glass/Ceramic Shrink-Wrapped Tray Guidelines

Glass bottles or jars that are shipped to Walmart in shrink wrap plastic are **required** to be shipped in a corrugated tray to help prevent damage. Cases may be contained with shrink wrap as long as the mil (thickness) can withstand abrasion, stacking, or protrusions encountered in normal handling, conveying, loading, and unloading. Corrugated trays are used to help with automation and conveyance through our distribution centers. The tray will help contain products and protect them from damage that occurs during conveyance and induction into automated facilities.

Packaging Requirements

- The case base and top are **required** to be continuous flat surfaces.
- Corrugated trays are **required** to have a minimum 3" high side wall, or to extend beyond the largest diameter of the bottle, whichever is smaller.
- Plastic shrink film is **required** to fit tightly around the case with no loose ends.
- Pack sizes with an aspect ratio (height/width) greater than 1.6 are required to ship in a full corrugated case and will be automation ineligible.
- Product shipped in trays is **required** to be weight bearing.
- Currogated or paperboard dividers are recommended between glass items.
- Pack configurations with an aspect ratio greater than 1.6 will be automation ineligible.
- Transparent film is preferred.
- See Case Quality, Shrink Wrap Items section of these standards for guidance on window/cutout allowances for trays.



Shrink Pack

Example Bottle Types



Apparel Packaging

This page provides standardized packaging guidelines for apparel items, enabling accurate shipping of product through the Fashion Distribution Centers (FDCs). This instruction applies to replenishment orders that flow through the FDC's only. Initial set items and eCommerce items are out of scope.

Apparel Carton Sizes

- Cartons shipping into our Fashion Distribution Centers will be received and sorted on equipment that is unique within our distribution system. The size of shipping cartons into our FDC's are **required** to fit within the following size constraints:

	Length	Width	Height	Weight
Minimum	6.4" (163mm)	5" (127mm)	2" (51mm)	1 lb (0.45 kg)
Maximum	36" (915mm)	24" (610mm)	16" (406mm)	50 lbs (23kg)

- Shipping cartons that are closest to the maximum dimensions shown will improve the efficiencies of our distribution centers and are more desirable. Cartons should be designed to maximize these efficiencies whenever possible.



NOTE - Hangtags for apparel garments should be visible through poly bag.

NOTE - Barcodes are to be located on the bottom right corner of standard polybags.

Inner Pack – Apparel Packaging

Similar to shipping cartons, apparel inner packs should be designed to maximize the efficiencies of our unique equipment whenever possible. Apparel items should be folded and placed into a polybag with the following maximum dimensions:

	Length	Width	Height
Maximum	19" (483mm)	17" (432mm)	9" (229mm)

- Inner packs are preferred to have the hangers completely enclosed within the polybag.
- Internal packs are **NOT ALLOWED** to be attached to the interior of the carton in any way.

Vacuum Sealed Inner Packs

- Vacuum Sealed Packs are **required** to maintain all of the same size and marking standards as inner packs in standard poly bags.

Inner Pack - Markings

Barcodes are **required** to be UPC-A

- Barcode may be pre-printed to polybag or applied via label.
- Hangtags are **required** to be visible through the polybag.

NOTE - Inner packs are NOT ALLOWED to hang from the carton in any way.



Shoe Packaging and Labeling

This section provides standardized packaging guidelines for shoe Suppliers, enabling accurate shipping of product through the Fashion Distribution Centers (FDCs).

Shoe Run Assortment

- Assortment shipping cases for shoes are **required** to include the size run marking on at least one of the long sides of the shipping case.
- A printed size run is **required**. The size run consists of a horizontal row indicating the sizes inside the case (starting with the smallest size on the left and ending with the largest size on the right).
- Below the first row is a second horizontal row indicating the number of pairs for each size listed above. **Exception:** *If a shipping case contains multiple size runs, the Supplier does not print the size run marking on the shipping case.*



Private label shoe shipping case

Shoe Carton Physical Requirements

- Shoe Cartons are **required** to meet the minimum material standards as shown below.
- Cartons should fit within the maximum physical weights and dimensions as shown below.
- If you are not able to meet the size requirements as shown, please reach out to the Senior Packaging Manager for approval at logpkg@wal-mart.com.

BURSTING STRENGTH	
Shoe Box	Outer Carton
450 P - ≥ 7.5 kg/cm ²	Refer to Corrugated Board Section of these Standards.
500 P - ≥ 8.0 kg/cm ²	
More than 500 P, or Corrugated Carton ≥ 8.8 kg/cm ²	

BOX / CARTON	MAX DIMENSION / WEIGHT	
Outer Carton	Max Dimensions	36" L x 24" W x 16" H 915 mm x 610 mm x 407 mm
	Weight	50 lbs
Shoe Box	Max Dimensions	18" L x 14" W x 7" H 457 mm x 356 mm x 178 mm

Shoe Packaging and Labeling - Inner Pack

This page provides standardized packaging guidelines for shoe Suppliers, enabling accurate shipping of product through the Fashion Distribution Centers (FDCs).

Inner Pack - Shoe Packaging

1. Plain brown corrugated box (the preferred package)

- These boxes are **required** to adhere to the minimum and maximum unit specifications shown on this page.
- Each individual box is **required** to be properly sealed on both ends and have an air hole punched in two sides where one of the holes must be accessible when the master case is opened. Holes are used to help remove the inner box from master case.
- Case packs should be packed for easy removal of product without tearing of cardboard, sealing tape, or otherwise damaging the barcode or exposing the pair inside the inner box.
- With box placed on the lowest center of gravity, barcode labels should be centered on the lower edge of side facing the direction of travel. The side facing the direction of travel is usually the side measuring the least width.

2. Poly bags must meet the following guidelines:

- Bags are **required** to fit tightly around the item with no excess plastic and be sealed securely to ensure product does not fall out of the poly bag.
- Bags should be opaque and not highly reflective.
- Shoes are **required** to be positioned in the bag in a manner that creates a flat surface on at least one side, allowing pairs to properly travel both powered and gravity conveyors and automation systems.
- A piece of chipboard placed under the shoe may be necessary to create a flat surface.
- Barcode labels are **required** to be centered on top of bag and work best when placed perpendicular to the direction of travel.

3. Anti-Mold Labels

- Anti-mold technology stickers are **required** to be placed on the inside of the polybag facing the shoes when chipboard is not used
- When chipboard is used, anti-mold technology stickers are **required** to be placed on the side of the chipboard that faces the shoes.

4. Examples of vendor pack/warehouse pack

- Packed 6/1 - Vendor must pack each pair individually. There will be 6 poly bags with 1 pair in each poly bag.
- Packed 6/2 - Vendor must pack 2 pair in each poly bag. There will be 3 poly bags with 2 pair in each poly bag.



Anti-mold sticker incorrectly placed on the chipboard facing away from the shoe.



Anti-mold sticker correctly placed on the chipboard facing the shoe.

NOTE - Shoe hangers are NOT ALLOWED in the eCommerce networks.

Unit Specifications

	Length	Width	Height	Weight
Minimum	6"	4"	2"	6 ounces
Maximum	18"	14"	7"	7 pounds

NOTE - There is no tolerance on the maximum height.

Unacceptable poly bags are dry cleaner bags and import poly bags made from polypropylene, referred to as PP.

Inner Pack - Barcodes

Barcodes are **required** to be EAN-13 printed on a 1" x 2" label

- 15 mil bar height .625"
- Pattern length 1.48"
- Examples of barcode placement



Barcode on side of least width on plain craft box



Barcode bottom left edge on standard shoebox



Barcode centered on poly bag, perpendicular to direction of travel

RFID Apparel Packaging, Introduction / Packaging Type

Introduction

To serve our customers right the first time, Walmart U.S. Supply Chain (store only) will be following all industry standards set forth by GS1 RFID serialized encoding standard, GS1 RFID tag placement standards, and Auburn University RFID Lab ARC inlay standards.

Seasonal Programs and Events

All seasonal program items are **required** to be RFID tagged. The only exception to this requirement is for Annual Event items.

Determine Inlay Manufacturer

National, Proprietary, and Supplier Brands

- Brand owners may select any Auburn University-approved inlay manufacturer listed on their website. Any inlay manufacturer not listed on the Auburn website cannot produce inlays for packaging being shipped to Walmart. Even if using an approved inlay provider, you must still submit samples to Auburn for final approval.

Private Brands

- All Walmart private brands must use an approved inlay manufacturer using W1-W6 specs, found on the Auburn University website: <https://rfidarc.auburn.edu/temp/suppliers.php>.

NOTE - This is not only about serialization of the tags as it pertains to the manufacturing of the blank inlays. Even if using an approved inlay provider, you are **required** to submit samples to Auburn for final approval rfidlab@auburn.edu.

Other Walmart nominated packaging resources are **required** to purchase their blank inlays from one of the four (4) companies below:

- Avery Dennison/Smarttrac
- Checkpoint
- R-PAC
- SML

RFID Apparel Packaging, Introduction/Packaging Type, cont...

All apparel brands that are being shipped into and sold at any of our Walmart U.S. stores **require** RFID tags. This includes all national, proprietary, Supplier, and private brands. SIOC items are out of scope. **All Apparel Items require** all shipments to both Store or eCommerce to **require** RFID tags. All items that are eCommerce only brands, team sports apparel and sports licensed hardlines “hot-market” Championship product (e.g. Superbowl, World Series, etc.) and items where RFID technology is not compatible, as identified through Auburn RFID Lab, are out of scope.

Apparel Departments that **Require** RFID Tagging

23-Mens Wear	29-Hosiery	33-Girls Wear
24-Boys Wear	29-Ladies Sleepwear	34-Misses & Juniors
25-Footwear	30-Bras & Shapewear	34-Plus Size & Maternity
26-Infant	31-Accessories	34-Outerwear & Sleepwear
29-Ladies Socks	32-Jewelry & Sunglasses	41-Team Sports



Example
RFID hangtag

RFID Application Based on Packaging Type

These are general guidelines. Consult the GS1 apparel placement guideline manual for product-specific placement, and adhere to GS1 standards.

EXISTING PACKAGING TYPE	RFID APPLICATION
Primary Branded Hangtag	Embed inlay into hangtag.
Size Strip	Add a joker ticket or embed inlay into primary hangtag; RFID placed within the size strip is NOT ALLOWED .
Joker Ticket/Sunglasses	Add a separate paper-based sticker or embed inlay into joker ticket .
Backer Card	Add a separate paper-based sticker.
Bellyband	Add a separate paper-based sticker.
Blisters/Clamshells	Add a separate paper-based sticker.
Header Card	Add a separate paper-based sticker.
Folding Carton	Add a separate paper-based sticker.
Jewelry Carding/Box	Add a separate paper-based sticker/email Auburn for further direction.
Wallet/Belt/Watch	Add a separate paper-based sticker or attach hangtag directly to item.
Poly bag	Add a separate paper-based sticker.
Collar Card	Add a generic embedded inlay hangtag.
Plastic Bottle	Add a separate paper-based sticker.
Metal Can	Email rifidlab@auburn.edu for further direction.

RFID Apparel Packaging, cont...

Tagging

- Sewing RFID inlay tags into the physical apparel item is **NOT ALLOWED**. Tags Sewn in that are easily removable by the customer are acceptable.
- RFID inlay stickers are **required** to be placed on packaging only.
- Staples, perfs, swiftach, folding, or diecuts through the inlay are **NOT ALLOWED**.
- RFID inlay placement on the bottom of poly bags, boxed items, or near the underwire for bras is **NOT ALLOWED**.
- Applying RFID to an EAS tag is **NOT ALLOWED**, unless you have special permission from Auburn University well in advance for proper testing.

Additional Information

For more information on the RFID program for apparel, including additional design details and packaging Sample submission instructions, review the Walmart RFID playbook located on Retail Link.

[Retail Link](#) > [Supplier Academy](#) > [Item Setup & Management](#) > [Business Specific Resources](#)

Online Submission Form

Complete the online submission form at <https://rfidlab.org/WalmartApparel/>.

Walmart Apparel Submission Form

Submit one UPC per Submission Form. Not all UPCs supplied by a supplier requires a validation, select one representative UPC (SKU) per:

1. Product Supplier
2. Brand
3. Packaging Type
4. RFID Packaging Provider
5. RFID Inlay Model
6. Tagging Location

If anything from 1-6 changes for any item, please submit that item in a new submission form.

Please note that this submission will not be processed and will fail automatically if any information is incorrect, incomplete, or not provided. This includes a correct/complete item file and tagging location photos. This submission process will have to be restarted if the validation fails which includes submitting a new form and shipping new samples.

Vendor Name *

Vendor ID *

This should be a six digit number.

Contact Name

Contact Email *

This will be the email address the PDF confirmation is sent to once the form is completed.

RFID Hardline Packaging

Introduction

To serve our customers right the first time, Walmart US Supply Chain (store only) will be following all industry standards set forth by GS1 RFID serialized encoding standard, GS1 RFID tag placement standards and Auburn University RFID Lab ARC inlay standards. All Sporting Goods brands that are being shipped into and sold at any of our Walmart U.S. stores **require** RFID tags. This includes all national, proprietary, Supplier and private brands.

DSV, Pay from Scan items, 3rd party WFS, D18 Seasonal, D56 Horticulture, and D67 Celebration items are out of scope. All orders that are NOT shipping to stores are out of scope, however it can still carry the RFID tagging if like item is at the store.

Hardline Departments that **Require** RFID Tagging

03-Stationery*	17-Home Décor
05-Media & Gaming*	19 -Crafts*
06-Cameras & Supplies*	20-Bath and Shower
07-Toys	21-Books*
09-Sporting Goods	22-Bedding
10-Automotive*	42-Automotive (Tires Only)
11-Hardware*	71-Furniture and Luggage
12-Paint*	72-Electronics
14-Kitchen & Dining	74-Closet and Organization
	87-Wireless

Determine Inlay Manufacturer

- Brand owners may select any Auburn University approved inlay manufacturer listed on their website. Any inlay manufacturer not listed on the Auburn website cannot produce inlays for packaging being shipped to Walmart. Even if using an approved inlay provider, you must still submit samples to Auburn for final approval.
- All brands must use one of the following approved inlay manufacturers from Auburn University website <https://rfid/auburn.edu/arc> using one of the W1-W6 specs.

NOTE - This is not about serialization of the tags as it pertains to the manufacturing of the blank inlays only. Even if using an approved inlay provider, you are **required to still submit samples to Auburn for final approval rfidlab@auburn.edu.**

All Items in departments indicated with (*) are required to be in compliance for all shipments that arrive in store on or before February 1, 2024.

Seasonal Programs and Events

All seasonal program items are **required** to be RFID tagged.

RFID Application based on Packaging Type

These guidelines are general in nature. Consult the GS1 apparel placement guideline manual for product specific placement and adhere to GS1 standards.

RFID Packaging, Hangtags

Branded Embedded Hangtag

Private Brands Only

- Changes to dielines or artwork will be managed through Walmart U.S. Packaging Team and their nominated packaging resources.

All Brands

- Embed inlay is **required** in branded hangtags.
- If you cannot execute for initial roll-out (S3 2021), you may use generic embedded hangtag for **initial shipment only**.

Generic Embedded Hangtag Format

Hangtag Dimensions: 83 mm x 25 mm | **INLAY size:** 70 mm x 14 mm (+/- 2 mm)

Minimum Copy **Requirements**

- UPC# (no bars; human readable)
- EPC logo
- Item description (from primary packaging)
- Additional information is allowed

Specifications

- Embed inlay between C2S paper stock
- **Material:** 14 pt.C2S minimum; glossy both sides
- **Font:** 12 pt. Bogle Regular (centered vertically and horizontally from left side of logo to right side of swift tag hole)
- **EPC logo:** Centered vertically and placed as shown below
- **Color:** Black ink on 1 side of tag

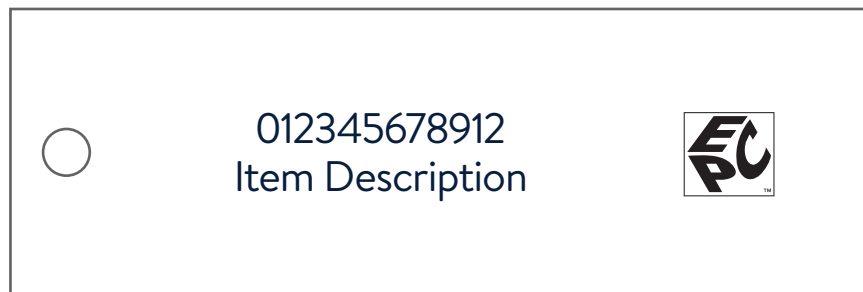

■ **For all garment tag locations, refer to GS1 US Placement Guidelines:** www.gs1us.org.

Folded Programs Only with Size Strip

- Fasten Swiftach embedded inlay hangtag through the inside left neck/left waist seam. Swiftach length is 1/2".
- If the item contains a joker ticket, either embed inlay into joker or add a separate generic embedded sticker. A scannable UPC is allowed on one or the other, not both.

Hanging Programs—Long Sleeve (all brands)

- Armhole placement is allowed.

D25 Shoe Hangtags (all brands)

- RFID hangtag is **required** to be affixed to shoe.
- Embed inlay into branded hangtag or add a generic embedded inlay hangtag.
- Attaching RFID stickers anywhere on the shoe box is **NOT ALLOWED**.

License Hangtags (all brands)

- May use RFID embedded Walmart generic price ticket.

RFID Packaging, Stickers

Generic Embedded Sticker with Scannable UPC Code

If you do not already have a scannable UPC barcode on the pack, Walmart prefers to use an EPC combo sticker as shown below.

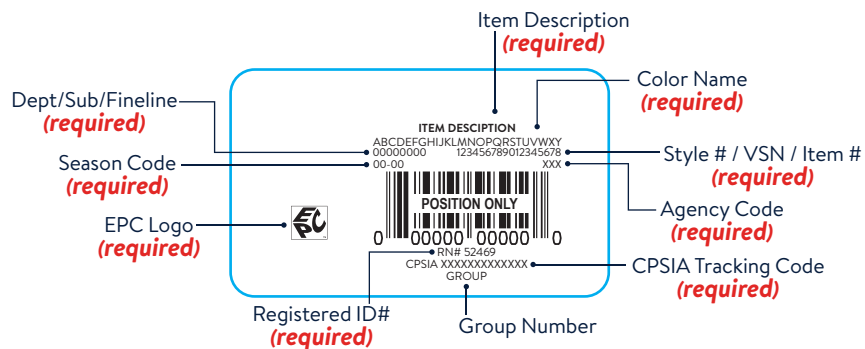

Specifications

- Embed inlay: 50 x 30 mm (+/- 2 mm)
- Tag dimensions: Supplier determines
- Material: Minimum 60#/8 pt Glossy (non-removable)
- Font: Bogle 5.5 pt
- Color: Black

Minimum Requirements

Private/Proprietary Brands:

- Barcode/UPC #
- EPC logo (place at bottom of UPC bars and scale to half of the bar height, minimum of 4.5 mm)
- Item Description (from primary packaging)
- Season code
- Dept/Sub/Fineline
- Color name
- Style number/VSN number /Item number
- Agency Code
- Registered Identification Number (RIN)
- CPSIA Tracking Code (D24/D26/D33 Only)

National/Supplier Brands:

- Barcode/UPC #
- EPC logo (place at bottom of UPC bars and scale to half of the bar height, minimum of 4.5 mm)
- Item Description (from primary packaging)
- Additional information is allowed

Generic Embedded Sticker without Scannable UPC Code

If you already have a scannable UPC barcode without an inlay, use a separate EPC sticker.

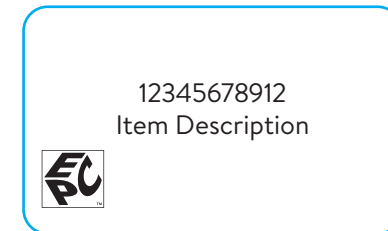

A generic embedded paper-based sticker can be added to the interior side (non-printed side) of the packaging as long as the EPC logo is added to the visible area (printed side) of the packaging, in proximity of the UPC barcode.

All Brands

- UPC # (no bars)
- EPC logo
- Item Description (from primary packaging)

Specifications

- Embed inlay: 50 x 30 mm (+/- 2 mm)
- Tag dimensions: Supplier determines
- Material: Minimum 60#/8 pt Glossy (non-removable)
- Font: Bogle 10 pt (centered vertically and horizontally)
- EPC logo position: Lower left corner (as shown)
- Color: Black

RFID Packaging, cont...

EPC Symbol

- The EPC logo example represents the bare minimum of information that should be shown on your packaging to identify RFID tagging.
- Any packaging that has an RFID tag is **required** to have the Electronic Product Code (EPC) symbol displayed on the packaging where customers and store associates can see it.
- The EPC symbol is **NOT ALLOWED** on any packaging that does not contain an RFID iLab, attaching tags with an EPC logo and/or inlay but not properly encoded can cause major confusion within the process.
- Go to this link for the EPC symbol image file and related documentation: www.gs1.org/standards/epc-rfid/guidelines

UPC to EPC Conversion

For information regarding the EPC data structure, visit the GS1 website. The EPC data structure is an industry standard and is maintained by GS1. The EPC Encoder/Decoder Tool can be found here: www.gs1us.org/tools/epc-encoder-decoder

Supplier Accountability

- Product Suppliers are **required** to have a process in place to ensure all tags leaving the facility are unique.
- Quality checking includes ensuring there are no duplicate tags or codes and that each tag is properly encoded for the item it is on.
- Any errors arriving at the stores will be the responsibility of Suppliers and all costs will be incurred by the Supplier.

Walmart Corporate, General Questions: WalmartRFID@Walmart.com
Websites:

<https://corporate.walmart.com/newsroom/videos/how-walmart-uses-electronic-product-codes>
<https://corporate.walmart.com/privacy-security/notices/>

Auburn University RFID Lab, General Questions: rfidlab@auburn.edu

ARC Website: <https://rfid.auburn.edu/arc/>

Shipping address:

Send five RFID inlays (no product unless called out differently) and photo showing tagging of item.

Auburn University RFID Lab
 Attn: WM Apparel RFID Validation
 1550 East Glenn Avenue
 Auburn, AL 36849 USA
 +1 (334) 844-7513

GS1 U.S., General questions about RFID encoding standards: walmartrfid@gs1us.org

Tag Data Standards, www.gs1.org/standards/epcrfid-epcis-id-keys/epc-rfid-tds

Apparel Placement Guideline, <https://tinyurl.com/2p8s2rjr>

Solution Partners, <https://tinyurl.com/ykbe6k2y>

RFID Packaging Providers, <https://RFIDpackagingResources.org>

Direct Store Delivery - ASN Shipping Label Requirements

Shipping Labels on Pallets, Totes, and RPCs

Suppliers are **required** to use a shipping label From: ASN deliveries.

- The GS1-128 barcodes embedded with an SSCC-18 on the physical products are **required** to match delivery paperwork.

■ **NOTE** - DEX deliveries do not require a shipping label

The following information is **required** on the shipping label:

- Store # - 5 digits (example, store # 00078)
- Last 3 digits of the invoice # (not applicable for Pay From Receipt - PFR- Suppliers)
- GS1-128 barcode embedded with an SSCC-18

The following information is **optional** on the shipping label:

- Ship From Address: Supplier's address, city, state, zip code
- Ship To Address: Walmart DC address, city, state, zip code including expanded GLN address
- Postal barcode
- Carrier name (if available)
- PO type - 4 digits (PO TYPE, e.g. 0020)
- BOL number (if available)
- Pro number (if available)
- Department number - 5 digits (Walmart DEPT number, e.g. 00013)

ASN Label Placement Guidelines:

- **Pallets:** Shipping label is **required** to be placed in the upper right corner. If multiple SSCC-18s apply to a single pallet, apply each shipping label to its corresponding layer in the upper right corner.
- **Totes or RPCs:** Shipping label is **required** on the front center.

Ship Form:		Ship To:	
SHIP TO POSTAL CODE (420) 33970		CARRIER	
		PRO:	
		B/L	
STORE#	TYPE	DEPT	INVOICE#
00078	0007	00056	356
ASN DELIVERY SCAN BAR CODE			
(00) 0 0843269 000012039 9			



Example only



Example only

Direct Store Delivery - Multi-Dept. Deliveries

Pallets and Racks

Cases are **required** to be separated by department.

For ASN: • A single delivery should reside as one shipment on one ASN document.
• Each pallet, rack, PO, and/or invoice **requires** a unique SSCC-18.

For DEX: • Each department **requires** an individual DEX invoice.
• Use tier sheets to separate each department.

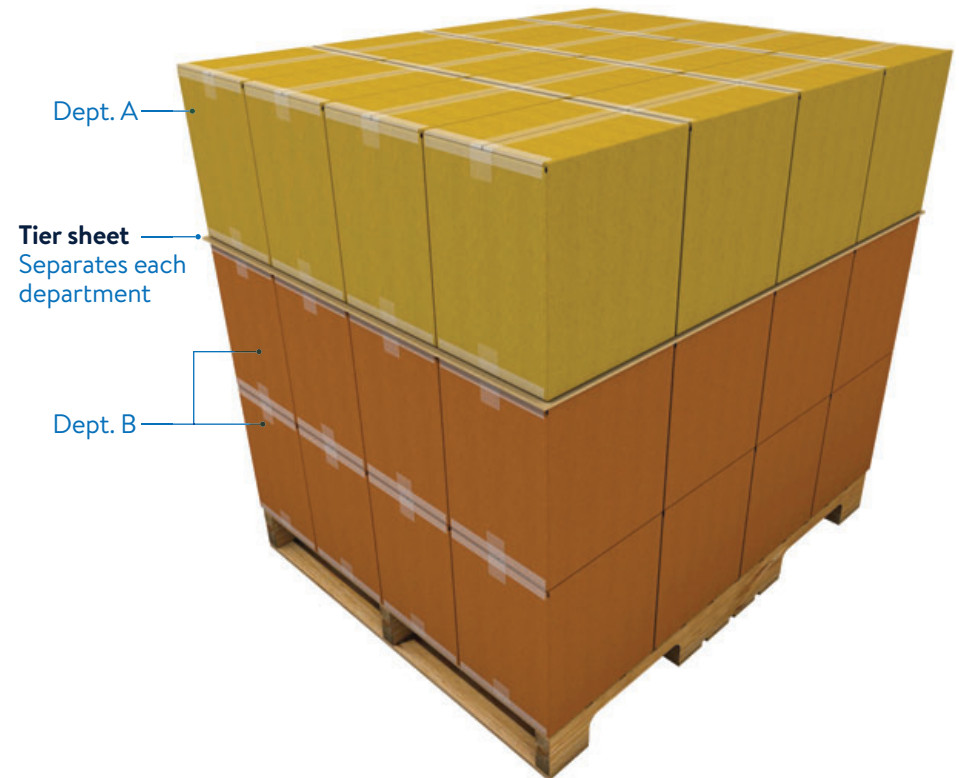

Totes and RPCs

Totes and/or RPCs are **required** to be separated by department.

For ASN: • A single delivery should reside as one shipment on one ASN document.
• Each tote and/or RPC **requires** a unique SSCC-18.

For DEX: • Each department **requires** an individual DEX invoice.



Direct Store Delivery - Case Markings

Accurate Deliveries Begin with Accurate Item File Setup

■ **GTINs allow associates to scan product without opening boxes.**

Corrugated Cases and Trays

- Orderable GTIN barcode is **required** in either ITF-14 for GS1-128 format.
- Orderable GTIN is **required** on a minimum of 2 sides with at least 1 side being the longest.
- See GTIN section of this guide for additional information on print quality and GTIN requirements.
- Cases and trays include all RRP/SRP/PDQ style packaging.

Totes and RPCs

Reusable plastic packaging used for Direct Store Delivery has no case marking requirements.



Sellable Unit Marking Requirements

Domestic Unit Markings for General Merchandise and Dry Grocery

Each selling unit is required to have a UPC or EAN GTIN barcode printed on it or label adhered to it. This GTIN is required to match the “Consumable” GTIN Field that is published to Item 360. If the item is individually poly bagged or placed in a case, then the case or poly bag must also include a matching selling unit barcode. This barcode is **required** to match what is entered in Online Item File (Item Setup).

- When the vendor pack is a single item or multiple items to be sold as a single selling unit (1/1), the UPC-A (GTIN12) or EAN (GTIN13) format barcode is **required** on the outer case.
- The 1/1 “Sellable Case Packs”, “SIOC – Ships In Own Container”, or “Ready To Ship” shall be labeled as such so the warehouse does not inadvertently separate or open such cases. See examples.

NOTE - Best Practice:

Include labeling - “THIS IS A SET. DO NOT SEPARATE.”

Location of this label can be either on the top of the case across the tape seam or beside the case GTIN barcode.

**THIS IS A SET
DO NOT
SEPARATE**

Figure A – Consumable GTIN



- Outer case contains the consumable GTIN barcode which is different from that of the inner units UPC.
- Because the selling unit quantity is ‘1’ (the entire case), the consumable GTIN barcode is used. Case is also pre-printed with ‘Ready To Ship’ markings.

Figure B – Orderable GTIN



- Outer case contains the orderable GTIN barcode.
- This barcode is suitable at the distribution level in instances where the case is not the intended selling unit. Because the case is the intended selling unit, GS1 Standards indicate a point of sale barcode should appear on the outer case.

Ships In Own Container (SIOC)

SIOC Packaging

Many items within the eCommerce environment **require** packaging that will allow the product to ship as-is to a customer with no additional packaging required. Any merchandise that is designated as “**ship-alone**” or “**ship as-is**” or “**ships-in-own-container**” must be capable of serving as the outbound shipping case when shipped to the customer. These items will not be over boxed by Walmart prior to shipment.

When is my item required to be SIOC?

If any one of the following conditions are met, your product is **required** to ship in its own case with and have packaging tested to comply with SIOC requirements. Other items outside of this list may be considered “SIOC” as well if determined by yourself or your merchant to have packaging that will ship to customer without requiring the item to be placed in an over box for shipping.

- Any item shipped into Walmart as a 1/1 item
- Any single side of case is greater than 25" in length - OR -
- The second largest side of case is greater than 20" in length - OR -
- The smallest side of case is greater than 14" in length - OR -
- The case weighs more than 30 pounds - OR -
- Volume is greater than 3.25 cubic feet - OR -
- Any item defined as “collectible”

Do not over pack or reinforce packaging during your ship test. Ship exactly how you intend to ship to the Walmart DC.



Protective Packaging Options

- Shipping case is **NOT ALLOWED** to contain cutouts or windows.
- Item is **required** to be no smaller than 75% of the outer packaging cube.
- Rugs, mattresses, and cushions in sturdy plastic bags that can ship as-is are acceptable.
- The poly bag, white or clear, should be at least 3 mil thick, be completely sealed, and include a UPC-A label on the outside of the poly bag.
- Rugs should be rolled with the pile on the inside for eCommerce shipments.
- Items that nest (stack inside each other), like plastic bins and garbage cans, are acceptable without ships as-is packaging.
- Supplier pack case weight and dimensions are **required** to be submitted to the Walmart.com buyer prior to initial shipment to the Walmart eCommerce network.
- Individual pack case weight and dimensions are **required** to be submitted to the Walmart.com buyer prior to initial shipment to the Walmart eCommerce network.

Ship Testing

Suppliers are **required** to conduct an ISTA ship test in accordance with Walmart standards. See General Requirements of this document for further information.

For concerns with SIOC requirements or to submit your passing ISTA ship test, contact Returns Management at: ISTATesting@wal-mart.com.

Collectible items are defined as an item that may be valued and sought by collectors (collectible sub-category and bobble-heads) with an emphasis on the product and cosmetics of the primary packaging. If the primary packaging is received by customer dirty, scratched, or dented, the item is considered damaged.

eCommerce Product-Specific Requirements

Liquid Packaging

Adequate packaging of liquid items flowing through the eCommerce network is critical to ensure the product does not leak before arriving at the customer's location. A package that leaks may also damage other products in the same case or in close proximity to the faulty liquid package. A liquid includes any chemical, food, or personal use liquid. Liquids are typically packaged with one of the following styles of packaging:

- **Spray Bottle:** Trigger is **required** to be blocked or shrink-wrapped to the side of the bottle to avoid damage.
- **Twist Cap Bottle:** Twist cap packaging is **required** to use shrink wrap, tape, an inner seal, or other sealing solution to prevent cap from unscrewing and/or leaking.
- **Flip Cap:** Flip caps are **required** to use shrink wrap, tape, or other solution to prevent cap from opening.
- **Pump:** Pump style packaging lids are **required** to use shrink wrap, tape, or other solution to prevent cap from opening.
- **Aseptic:** Aseptic style packaging is **required** to follow Walmart Fragile Packaging standards. Refer to Fragile Packaging section of this guide.



Granule Packaging

Granule packaging includes the packaging of any fine powder or granule product, such as sugar, baking soda, salt, and flour. Granule packaging is **required** to be in an airtight, sealed primary package or in a shrink-wrapped primary package.

Nesting Items

Product that nests and may create suction when separated causes inefficiencies in our processes and may cause damage to the product. Examples include plastic storage bins and plastic paint buckets. Nesting items are **required** to use paper, paperboard, corrugated board, or other material between the product to provide breaks in the airflow between the products and prevent damage from separation and vibration.

Sharp Items

Sharp products (i.e., any product that has a sharp or pointed edge such that, when exposed, the edge would present a safety hazard to associates, carriers, or customers receiving or unpacking the product) is **required** to be packaged so that the sharp or pointed edge will not become exposed during the normal course of order fulfillment (includes all processes from receipt to customer opening of the product).

- Cardboard or plastic sheaths alone are not sufficient protection unless the sheath is constructed of a rigid, durable plastic and secured to the product so it cannot slide off in transit.
- Sharp items are **NOT ALLOWED** to be packaged with non-sharp items.
- Outer boxes with sharp items are **required** to be labeled as such.



Drop Ship Vendors

NOTE – DSV Suppliers are **required** to adhere to all general case quality, plastic bag, pallet, lithium battery/hazardous material markings, and eCommerce test standards.

DSV Shipping, Packaging, and Labeling

Suppliers are **required** to ship with all carrier and shipping methods assigned by Walmart. Walmart will assign a carrier and ship method for each order. Suppliers are **required** to ship according to the Walmart assigned carrier method. Suppliers will only ship orders from inside the contiguous 48 states. Shipping from Hawaii or Alaska is **NOT ALLOWED**.

Suppliers are **required** to ship in plain, unbranded cases. Packing slips or marketing materials are **NOT ALLOWED** in the case.

Suppliers will print labels for both direct customer shipments (also referred to as Site to Home or S2H) as well as Site to Store shipments (also referred to as S2S). S2S shipments allow the customer to pick up their order from a Walmart store location of their choosing.

When creating a Site to Home (S2H) label, the following items are **required**:

- Return address is the Return Center closest to your location (see chart at right).
- Customer's address and phone number.
- The PO number for the order.

When creating a Site to Store (S2S) label, the following items are **required**:

- Return address is the Return Center closest to your location (see chart at right).
- Ship to address will read:
“PICKUP AT STORE”
Street address of store
Customer name
City/State/Zip/Phone of store location
- The PO Number for the order.
- ASN Barcode for the order
(may be printed and applied on a separate label as needed).



Plain, unbranded case

Label recommended placement left of center on long side of case. See next page for label samples.

Return Center Addresses

Vendors must choose which Walmart Return Center to have their items shipped to when a customer returns an order. Effective immediately, vendors should choose the closest Return Center to their facility from the addresses below when entering the return address on shipping labels. This change does not affect in-store returns.

Walmart.com

5795 N. Blackstock Road
Spartanburg, SC 29303

Walmart.com

2301 Corporation Parkway
Waco, TX 76712

Walmart.com

6719 W. 350 North
Greenfield, IN 46140

Walmart.com

3382 Marion Drive
Las Vegas, NV 89115

Walmart.com

1161 Enterprise Road
Johnstown, NY 12095

Jewelry Returns ONLY - Walmart.com

1206 S. Broadway
Marlow, OK 73055

NOTE - All jewelry items must be sent to Marlow, OK Return Center.

Drop Ship Vendors - Carrier Labels

FedEx Carrier Labels

The return address should be the Return Center closest to your facility.

The PO # should be visible here.

ORIGIN ID: (800) 356-8548
 RETURN CENTER
 2391 CORPORATION PARKWAY
 WACO, TX 76712
 UNITED STATES US

SHIP DATE: 21 APRIL 18
 ACTWGT: 1.00 LB
 CAD: 111444556/WS13200
 BILL SENDER

TO SAM WALTON
 702 S.W. 8TH ST.
 BENTONVILLE AR 72716
 (555) 555-5555

PO: 1ZWYX0360073 DEPT: 1ZWYX0360073

TRK# 7721 0445 6515 ** 2DAY **
 02971

SH ROGA 72716
 AR-US TUL

Site to Home (S2H) Label - Sample

The return address should be the Return Center closest to your facility.

The ship to address should always read "TO: Pickup at Store" followed by the street address and the customer's name

The ASN barcode should be included on the S2S shipping label.

FROM: (800) 356-8548
 RETURN CENTER
 2391 CORPORATION PARKWAY
 WACO, TX 76712
 UNITED STATES US

SHIP DATE: 21 APRIL 18
 ACTWGT: 1.00 LB
 CAD: 111444556/WS13200
 DIMMED: 5 x 8 x 13 IN
 BILL 3rd PARTY

TO PICKUP AT STORE
 406 S WALTON BLVD
 John Smith
 BENTONVILLE AR 72716
 (555) 555-5555

PO: 1ZWYX0360073 DEPT: 1ZWYX0360073

TRK# 7721 0457 6807

72712
 9532 0417 0 (00 000 0000) 0 00 7721 0457 6807

Site to Store (S2S) Label - Sample

UPS Carrier Labels

The return address should be the Return Center closest to your facility.

The customer's phone number should be printed along with the address.

The PO # should be visible here.

Walmart.com/Jet RETURNS 3 LBS 1 OF 1
 6716 W. 350 NORTH GREENFIELD, IN 46140 DWT: 10.76

SHIP TO:
 JOHN SMITH
 123 Main Street
 (888) 555-4102

SEATTLE WA 98102

WA 981 9-01

UPS GROUND
 TRACKING #: 1Z S89 Y4Y 03 9508 SS97

Billing: 3RD PARTY

REF 1: 12788125
 REF 2: 12788125

Site to Home (S2H) Label - Sample

The return address should be the Return Center closest to your facility.

The customer's phone number should be printed along with the address.

The PO # should be visible here.

Walmart.com/Jet RETURNS 3 LBS 1 OF 1
 6716 W. 350 NORTH GREENFIELD, IN 46140 DWT: 10.76

SHIP TO:
 PICKUP AT STORE
 406 S Walton Blvd.
 John Smith
 Bentonville, AR 72712
 (888) 555-4102

AR 981 9-01

UPS GROUND
 TRACKING #: 1Z S89 Y4Y 03 9508 SS97

Billing: 3RD PARTY

REF 1: 12788125
 REF 2: 12788125

If the ASN barcode is not included, print an ASN label in Supplier Center.

Site to Store (S2S) Label - Sample

USPS Carrier Label

Click-N-Ship®
 P \$1152 US POSTAGE
 11/11/21 1 lb 0 oz

USPS TRACKING™ Number: 9409 9036 9930 0455 9403 89
 Priority Mail® Postage: \$7.48
 Total: \$7.48

USPS PRIORITy MAIL®
 0006
 Walmart.com/Jet RETURNS
 6719 W. 350 NORTH GREENFIELD, IN 46140

SIGNATURE REQUIRED

SHIP TO:
 ANNIK CLOVER
 850 CHERRY AVE
 SAN BRUNO CA 94066-3031

USPS TRACKING™
 420 97211 9405 5036 9930 0455 5403 89

Electronic Rate Approved #038555749

Online Label Record (Label 1 of 1)
 USPS TRACKING™ Number: 9409 9036 9930 0455 9403 89
 Print Office: 20000207 Priority Mail® Postage: \$7.48
 Transaction #: 20000207 Total:
 Ship Date: 05/11/2023
 Weight: 2 lb 0 oz
 From: FRANK RUDZ ZNAO
 10485 E WALKER DR RM R1000
 WACO TX 76712
 To: ANNIK CLOVER
 7911 N.E. 33RD DR STE 310
 COO 020225
 PORTLAND OR 97211-1988

Instructions
 1. Each Click-N-Ship® label is unique. Labels are to be used as printed and used only once. DO NOT PHOTO COPY OR ALTER LABEL.
 2. Place your label so it does not wrap around the edge of the package.
 3. Adhere your label to the package. A self-adhesive label is not required. Labels are printed on a white background. OVER MARKCODE. Be sure all edges are secure.
 4. To mail your package with PC Postage®, you may schedule a Package Pickup online, hand to your carrier, take to a Post Office™, or drop in a USPS collection box.
 5. Mail your package on the "Ship Date" you select when creating this label.

Thank you for shipping with the United States Postal Service!
 Check the status of your shipment on the Track & Confirm page at usps.com

NOTE – For additional information on DSV shipments, including onboarding, item setup and management, EDI, Retail Link, and other questions, visit [DSV Supplier Help](#). **You must be logged in to view this information.

Drop Ship Vendors - Freight Shipping Labels



Freight Shipping Labels

Suppliers are **required** to use one of the standard shipping label formats detailed on this page. Walmart does not provide a template for this label. It is the Supplier's responsibility to create the label.



A domestic shipping label is **required** for all freight shipments. The recommended size for shipping labels is 4" x 6" when including the barcode information, but can vary with different sized boxes as needed.

Standard shipping labels are **required** to contain the following:

<ul style="list-style-type: none"> • Return Address: Return address is the Return Center closest to your location. • Ship To Address (S2H): Customer's address and phone number • Ship To Address (S2S): Ship to address will read "PICKUP AT STORE" Street address of store Customer name City/State/Zip/Phone of store location 	<ul style="list-style-type: none"> • PO number - 10 digits (ORDER #) • Walmart Item Number (WMIT)
<ul style="list-style-type: none"> • Postal barcode (optional) • Carrier name (if available) 	<ul style="list-style-type: none"> • BOL number (if available) • Pro number (if available)

Return Address: Return Address is the Return Center closest to your location.	Ship To: CUSTOMER'S ADDRESS PHONE NUMBER	
POSTAL CODE (420) 72712 	CARRIER Carrier Name PRO: 1234567890 B/L: 1234567890	
PO# 0000000000	BOL 00012	PRO# 1234567890 WMIT: 001286123
 (00) 0 0614141 123456789 0		

Site to Home (S2H) - Sample

Return Address: Return Address is the Return Center closest to your location.	Ship To: CUSTOMER'S ADDRESS PHONE NUMBER	
POSTAL CODE (420) 72712 	CARRIER Carrier Name PRO: 1234567890 B/L: 1234567890	
PO# 0000000000	BOL 00012	PRO# 1234567890 WMIT: 001286123
 (00) 0 0614141 123456789 0		

Site to Store (S2S) - Sample

Walmart Fulfillment Services (WFS)

NOTE - WFS sellers are **required** to adhere to all general case quality, general carton markings, lithium battery/hazardous material markings, SIOC, product-specific requirements, BOL/packing list requirements,, and eCommerce test standards.

WFS Inventory Types

Sortable inventory is defined as items that weigh less than 30 lbs. with a maximum length of 25", maximum width of 20", and a maximum height of 14".

Non-sortable inventory can have a maximum weight of 150 lbs. with a maximum dimension of 108" and a length + girth measurement of no greater than 165". All cartons over 50 lbs. in weight are **required** to have "Team Lift" markings on the tops and sides. All cartons over 100 lbs. in weight are **required** to have "Mech. Lift" markings on the tops and sides.

Shipping and Palletization

All shipments that are not small parcel are **required** to be palletized. Grade A wooden pallets are **required** to meet Walmart pallet standards. The use of pooled pallets, generic block pallets, or any other type/style of pallet is **NOT ALLOWED**. Single pallet height is **NOT ALLOWED** to exceed 72". Double stacked pallets are **NOT ALLOWED** to exceed 108" in height, including the height of the pallet.

Labeling Requirements



For all shipments, sellers will print and place labels generated by the WFS Send Inventory Portal when you have created your shipment. The label information is **required** to include:

- WFS shipment ID
- WFS shipment ID barcode
- Return to (ship from) seller name and address
- Ship to address
- Pallet/box counts
- Label type: Mixed SKUs cartons, single SKU carton, or pallet
- A shipping label is **required** for each carton shipped.



Plain, unbranded case

Recommended placement of label left of center on long side of case. See below for label sample.

RETURN TO: SELLER NAME SELLER ADDRESS CITY STATE, 00000	Walmart Fulfillment Service
FILL OUT: BOX ____ OF ____ PALLET ____ OF ____	SHIPMENT ID: 01234567890 
SHIP TO: WALMART FC NAME FC NAME CITY STATE, 00000	
SHIPMENT ID BARCODE:  01234567890	
CIRCLE ONE: MIXED SKUS SINGLE SKU PALLET	

WFS shipping label

Walmart Fulfillment Services (WFS), cont...

Labeling Requirements, cont.

All palletized shipments will **require** 2 pallet labels.

- Pallet labels are **required** to be placed in upper right corner of pallet.
- Pallet label can be applied on top of or between stretch wrap layers.
- Pallet labels are **required** to be on adjacent corners of pallet.
- Each shipment ID is **required** to have an individual pallet label associated with it. For a palletized shipment with multiple shipment IDs, additional labels should be affixed below the initial label in the upper right corner.
- Single SKU items should be placed on a single pallet when quantities allow. Splitting quantities of the same product when they can fit on a single pallet is **NOT ALLOWED**.



Pallet labels are **required** to be in the upper right corner of adjacent sides of the pallet.

WFS Product Preparation

- All products are **required** to be in a sealed or closed container and ready for sale.
- All internal (saleable) units are **required** to be in clear or see-through poly bags. Fulfillment Centers will re-bag items packaged in non-clear or opaque poly bags before the items are available to sell, which may cause delays.
- Price tags, product labels, and/or any retailer-specific labels are **NOT ALLOWED**.
- All perishable goods are **required** to contain a visible expiration date on the selling unit packaging.
 - Lot Code/Best if used by date is **required** when applicable. Minimum font size of 1/2" 48 pt is **required**. Preferred date format of MM/DD/YYYY.
 - Products that expire and are contained in packaging that **requires** additional prep, such as glass jars or bottles, are **required** to have the expiration date accessible during receiving at the FC.
 - Perishable Items that **require** temperature control are **NOT ALLOWED** (e.g., ice cream that needs to be kept in a freezer or chocolates that may melt).
- Any item received as ready to ship (SIOC) will be packaged at the discretion of the FC.
- Marking all items with country of origin (COO) is preferred.
- Packaging inserts and other forms of marketing materials are acceptable. These materials should not be specifically designed for other non-Walmart Fulfillment Services platforms.
- Failure of the seller to properly prep and pack the shipment may result in seller being responsible for additional handling charges, which will be determined on an individual basis.
- Units that require assembly of multiple pieces by the FC are **NOT ALLOWED**.
- The following forms of packing materials are **NOT ALLOWED**:
 - Styrofoam peanuts
 - Biodegradable packing peanuts
 - Cornstarch packing peanuts
 - Crinkle wrap
 - Shredded paper

Walmart Fulfillment Services (WFS) Master Packs

Mixed Master Pack

- Master packs are allowed in **eCommerce network only**.
- A mixed master pack is a package shipped from the seller to the Fulfillment Center that contains multiple vendor packs inside a single case.
- It is not recommended to ship in mixed master packs. Purchase orders are written specifying the number of vendor packs ordered, and that should be the quantity configuration.
- Shipping in a configuration different than what the PO specifies may result in delayed payment, claims, wrong quantities to customers, delayed processing, product refusal, and many other issues.
- Within eCommerce environment smaller items may **require** mixed master packing. If your vendor pack does not meet the minimum automation eligible sort requirements, you are **required** to contact the Packaging/Labeling Team at: labeling@walmart.com for approval of mixed master packing.
- Seller is **required** to apply three STOP labels to master case.
 - One on each long side
 - One on top
 - At least one STOP label is **required** to be placed near the domestic shipping label.
- STOP labels are **required** to:
 - Use the following language: STOP | MIXED MERCHANDISE | RECEIVE AS BREAK PACK
- STOP label recommendations:
 - Font: Arial Bold | Minimum of 48 pt | ALL CAPS
(Smaller font may be used if master case is prohibitively small.)
 - Use red ink on a white background (black ink on a white background is acceptable).
- Domestic shipping label is **required** to state "MASTER PACK" in WMIT field.

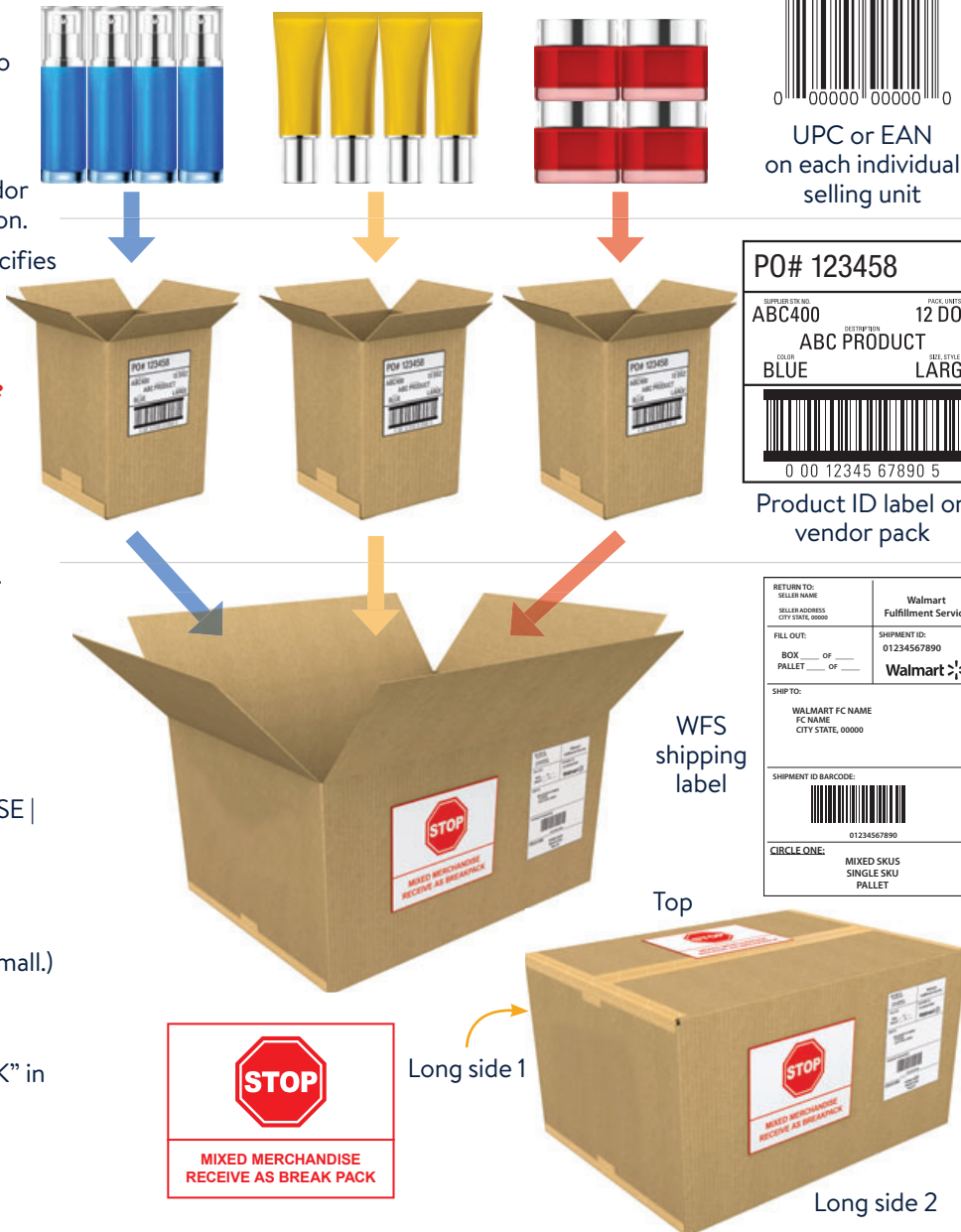



0 00000 00000 0
UPC or EAN
on each individual
selling unit

Selling Unit
Selling unit must be individually packaged (poly bag or case) and placed within the corresponding vendor pack.

PO# 123458
SUPPLIER SKU NO. ABC400 PACK UNITS 12 DOZ
COLOR BLUE PRODUCT ABC PRODUCT SIZE STYLE LARGE

0 00 12345 67890 5
Product ID label on
vendor pack

Vendor Pack
Each vendor pack is **required** to contain applicable case markings (product ID info) and orderable GTIN barcode in either ITF-14 or GS1-128 format. If possible, include WMIT.

RETURN TO:
SELLER NAME
SELLER ADDRESS
CITY STATE 00000
Walmart Fulfillment Service
SHIPMENT ID: 01234567890
Walmart ✨
SHIP TO:
WALMART FC NAME
FC NAME
CITY STATE 00000
SHIPMENT ID BARCODE:

01234567890
CIRCLE ONE:
MIXED SKUS
SINGLE SKU
PALLET

Master Case
Barcodes other than the postal code and the SSCC-18 are **NOT ALLOWED** on the domestic shipping label for master packs.

Combining multiple POs within the same master pack case is **NOT ALLOWED**.

STOP label is **required** to be clearly indicated on or alongside the domestic shipping label.

STOP label is **required** to be included on the two long sides of the master pack case.

DSDC Supplier Requirements

To be considered for conversion to DSDC, contact your Walmart Buyer, Replenishment Manager, or the DSDC Program Manager.

- Suppliers shipping DSDC need to adhere to all General Merchandise case marking and quality standards.
- Shipping label requirements for DSDC supersede General Merchandise shipping label requirements.
- For additional information, see [Retail Link > Supplier Academy > Ordering & Replenishment > Walmart's Supply Chain](#).

■ **NOTE** - Each vendor number is unique and is required to be treated separately. Suppliers with more than one vendor number are required to keep them separate in the DSDC system.

The following requirements must be met for the DSDC process to work correctly.

Electronic Data Interchange Requirements (EDI)

Each DSDC order **requires** an ASN sent from Supplier to facilitate receiving and shipment to store from the RDC.

The following transactions must be supported by Supplier:

- Mapping documentation for each item below can be obtained through the Walmart EDI Help Desk at 479-273-8888 or via Retail Link on the EDI/eCommerce site.

EDI-810 Electronic Invoice	EDI-824 Application Advice
EDI-850 Electronic Purchase Order	EDI-864 Text Message
EDI-997 Functional Acknowledgment	EDI-856 Advance Shipment Notification

■ **NOTE** - Suppliers are required to have access to Retail Link. Contact your Buyer for access.

- Collect Suppliers are **required** to establish a ship point ID (if none exists or for new locations). Open a ticket with Walmart Transportation at <https://wal-marttransportation.na1.teamsupport.com> for support.

DSDC Supplier Requirements, cont...

ASN Validation

Data Validation

- EDI-824 Application Advice (Critical Errors) – This document will be transmitted if any of the following errors occur during ASN transmission.
 - Structural integrity or...
 - Invalid item or...
 - Invalid GTIN or...
 - Overages
- Review EDI 997 Functional Acknowledgment and EDI 824 Application Advice error messages daily.
- Respond to any EDI 856 ASN errors within 2 hours of receiving notice of the errors. Merchandise will not be received at Walmart DCs without a successful ASN transmission.
- If it is necessary to send an update to an EDI 856 transaction, the complete transmission is **required** to be resent.
- Invoices are **required** to be consolidated at the PO/item level (not store level) and billed to the DC.
- ASNs are **required** to contain individual case content. Item quantities are **required** to be transmitted in single selling units and in warehouse pack multiples.

DSDC Replenishment Requirements

- DSDC POs are type 0073.
- Warehouse packs are **required** to equal vendor packs. Break packs are **NOT ALLOWED**.
- Back orders or item substitutions are **NOT ALLOWED**.
- When canceling POs or lines on the PO, cancellation is **required** to be executed in both Supplier's and Walmart's systems. Maintenance is **required** to be completed prior to the cancellation date in Walmart's system.
- ASN is **required** to reflect all changes made to the PO. If a change is received after an order has shipped, notify Buyer to change the PO back so that it matches what has been shipped.
- DSDC POs should not be changed in Walmart's system after transmission to Supplier.

DSDC Supplier Requirements, cont...

Custom Packed Cases

- All inner packs are **required** to have an exposed, scannable UPC barcode that does not require the pack to be opened to facilitate scanning.
 - Inner packs should not be labeled (exclusively) with an ITF-14 barcode.
 - Inner packs should have a barcode format that can pass point of sale (**UPC-A, UPC-E, EAN-13, EAN-8**).
- All warehouse packs are **required** to be packaged sufficiently to prevent items from being separated during transit or handling.
- All warehouse packs are **required** to remain intact. Single selling units cannot be split between multiple cases. Splitting single selling units in a warehouse pack between two or more cases will result in non-receipt of the split goods and a claim being filed against the invoice.
 - All ASNs are **required** to be sent with full multiples of the warehouse pack size.
 - This is an issue for Suppliers who ship in single selling units and have items set up with a pack size greater than 1.
- Only one store and one order can be packed into a single shipping container.
- Each shipping container is **required** to be identified with an approved SSCC-18/128 label.
- SSCC-18/128 number generation algorithm should not allow a pack “license plate” number to be repeated for 2 years.
- All shipping containers are **required** to be automation eligible.

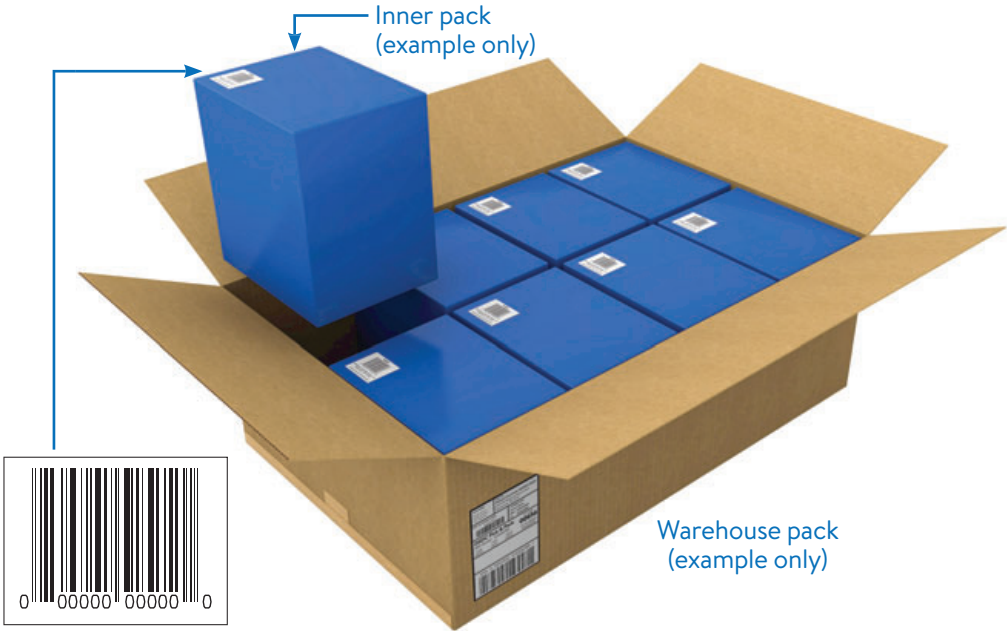

Minimum requirements
 6.4" L x 5.0" W x 2.0" H (minimum 1 lb.)
 163mm x 127mm x 51mm (0.45 kg)

Maximum requirements
 36" L x 24" W x 16" H (maximum 50 lbs.)
 915mm x 610mm x 407mm (23 kg)



DSDC Supplier Requirements, cont...

Multiple POs in One Container

- Some Suppliers that have merchandise in more than one department will be allowed to combine and pack multiple POs in the same container.
- Before shipping multiple POs in a single container, approval is **required** to be obtained from:
 - Buyer
 - EDI
 - DSDC Manager
- Orders should be combined by store number so that only one store is packed into a single container.
- Each shipping container is **required** to be identified with an approved SSCC-18/128 label. The label is **required** to list all POs within the container.
- All POs are **required** to be transmitted in one ASN. If there is a problem with one PO that **requires** ASN retransmission, all POs must be retransmitted.
- Suppliers not shipping weekly replenishment orders are **required** to send a test shipment at least 1 week prior to the **required** ship date. This is to allow time for identifying and working through any issues.



PDQ display (example only)



Warehouse pack (example only)

SHIP FROM: Supplier Name Supplier Address City, State, Zip		SHIP TO: Walmart Dist Center #6094D-DSDC 6841 SW Regional Airport Blvd Bentonville, AR 72712	
SHIP TO POSTAL CODE: (420) 72712		CARRIER INFO Carrier Name PRO: 1234567890 B/L 1234567890	
DSDC Multi-PO			
DC# 06094	TYPE 0073	DEPT 00012	PO NUMBER 1234567890
STORE# 04321		00023	2345678901
		00034	3456789012
		00045	4567890123
Vendor: 123456		00056	5678901234
(00) 0 0012345 123456789 1			
[Barcode]			

SSCC-18/128 (example only)

Multiple POs (example only)

DSDC Shipping Label Specifications

DSDC Shipping Labels

- Shipments are **required** to be palletized and stretch-wrapped.
- Multiple orders destined for the same DC can be combined on a pallet.
- One bill of lading clearly identifying all PO numbers and cases shipped is **required** per DC.
- Packing lists are not required.

DSDC Label Information

Each store-specific shipping container **requires** a single SSCC-18/128 shipping label.

This label is **required** to contain the following information:

Ship From	Supplier name Supplier address City, state, zip code
Ship To	Walmart distribution center (#_ _) D-DSDC Walmart address City, state, zip code
Ship For	Store number (5 digits)
PO #(s)	DC facility/location number (5 digits) Order type (4 digits) Department number (10 digits) DSDC pick & pack (order type SSCC-18) Serial shipping container barcode (20 digits)

DSDC Shipping Label Specifications, cont...

Optional Label Information

- Postal zip – barcode
- Walmart-assigned vendor number (6 or 9 digits)
- **If available at the time of print, the shipping label should also include:**
 - Carrier name
 - Pro number
 - B/L number

Barcode Segment Specifications

- Start Code/FNC1 **00 0 0012345 55555555 8** C Stop Character
- ST AI CT MI SN CD C1 SP
- **ST** SSCC-18/128 Start Code (consisting of Start - C plus Function Code 1)
- **AI** SSCC-18/128 Serial Shipping Container Application Identifier
- **CT** Shipping Container Type
- **MI** UCC/EAN Manufacturer ID Number including Number System Character preceded by zero
- **SN** Shipping Container Serial Number
- **CD** Modulus 10 Check Character
- **C1** Modulus 103 Check Character (symbol character)
- **SP** Stop Character

NOTE - *The SSCC-18/128 Serial Shipping Container Code is a numeric-only application standard. Only numeric data (other than start, modulus 103 check digit, and stop characters) are to be encoded in the symbol.*

DSDC Shipping Label Specifications, cont...

Sample Label Formats

SHIP FROM: Vendor Name Vendor Address City, State, Zip	SHIP TO: Walmart Dist Center #6094D-DSDC 6841 SW Regional Airport Blvd Bentonville, AR 72712		
SHIP TO POSTAL CODE: (420) 72712 	CARRIER INFO Carrier Name PRO: 1234567890 B/L 1234567890		
DSDC Pick & Pack STORE#			
WM Vendor: 123456789 00656			
DC#	TYPE	DEPT	PO NUMBER
06094	0073	00052	1234567890
(00) 0 0012345 123456789 1 			

Single PO per pack/container
(example only)

SHIP FROM: Supplier Name Supplier Address City, State, Zip	SHIP TO: Walmart Dist Center #6094D-DSDC 6841 SW Regional Airport Blvd Bentonville, AR 72712		
SHIP TO POSTAL CODE: (420) 72712 	CARRIER INFO Carrier Name PRO: 1234567890 B/L 1234567890		
DSDC Multi-PO			
DC#	TYPE	DEPT	PO NUMBER
06094	0073	00012	1234567890
		00023	2345678901
		00034	3456789012
		00045	4567890123
Vendor: 123456		00056	5678901234
(00) 0 0012345 123456789 1 			

Multiple POs per pack/container
(example only)

DSDC Shipping Label Specifications, cont...

DSDC Case Barcode Location

Case barcode is **required** to be placed on each case to ensure proper scanning in automated environments and to prevent damage of barcode due to “edge crush.” Adhere to these guidelines when placing case barcodes.

- Shipping container barcode is **required** to be placed to the left of center on the longest side of the case.
- Bottom of the bars are **required** to be no less than 1.25 inches and no more than 3 inches above the container’s natural bottom.
- Outer edge of the right quiet zone is **required** to be no closer than 0.75 inches from the right edge of the vertical face.
- Do not cover or obscure the product identification symbol (GTIN barcode) when affixing the SSCC-18/128 label.
- Supplementary identification (SSCC-18/128) should be placed to the left of the primary product ID when it appears on the same panel.
- If shipping container has a height of less than 3.5 inches and barcode symbol cannot be placed on the side of the package as specified above, shipping label may be placed on top of the package. In this case, label is **required** to be placed with the bars perpendicular to the shortest side and no closer than 1.25 inches from any edge.

For questions and concerns regarding conversion to DSDC contact your replenishment manager.



Place shipping label on top if it will not fit on the sides.

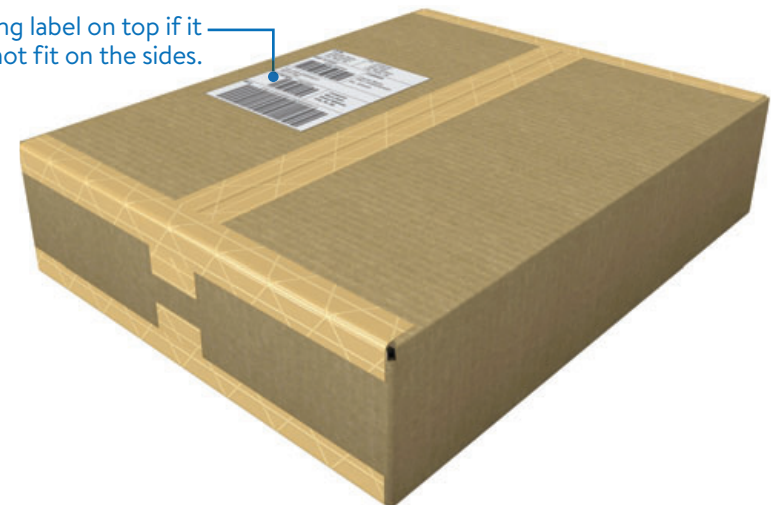

Consolidation Centers

ACC/MCC Special Requirements

NOTE - Suppliers shipping to Consolidation Network are **required** to adhere to all General Merchandise case markings, labeling, and quality standards as well as all Shipping and Routing Documentation standards.

If your shipping case does not meet these dimensional requirements, contact logpkg@wal-mart.com.

Dimensions		Length (in)	Width (in)	Height (in)	Weight (lbs.)
Cases	Max	48"	23"	30"	60
	Min	5"	3.5"	2"	1

Collect Suppliers Shipping to Walmart Consolidation Center



Consolidation centers play a specialized role in moving products quickly on their journey to the customer. These centers process or receive general merchandise from Suppliers, consolidate quantities of this freight in a full truckload (FTL), and ship it to Walmart regional distribution centers. Questions? logpkg@wal-mart.com

Routing

- **Confirm Shipment** by 4:00 P.M. (CST) the day after the order is transmitted, including weekends.
- Orders routed outside these parameters are non-compliant and are subject to OTIF fines.
- **Confirm Shipment** can be accessed via the Transportation Supply Chain Portal 2.0 app located under the Apps section on Retail Link.
- Suppliers may also be part of the Auto Ready or DC Pooling Programs.

Loading

- Single PO pallets
- MPP (Multiple POs on a single pallet) is a shipping method which **requires** following specific instructions. **Refer to following pages for information.**
- All cases are **required** to be clearly segregated by purchase order number.
- Loading staple stock and assembly POs on the same pallet is **NOT ALLOWED**.
- Ensure compliant labeling (case and pallet) per Walmart Secondary Packaging Standards.

Shipping

Packaging Requirements

Walmart Secondary Packaging Standards:
[Retail Link > Supplier Academy > Item Setup & Management > Packaging and Labeling](#)

Shipping Requirements

Walmart Shipping and Routing Guide:
[Retail Link > Supplier Academy > Quick Learning Articles > Ordering and Replenishment > Shipping, Routing, Packaging, and Labeling](#)

Consolidation Centers, BOL, Multi-Stop and Overflow

Consolidation Bill of Lading Requirements (GMC/MCC only), Master Bill of Lading Plus Individual Purchase Order/DC Destination

Master BOL	Individual BOL	Intermodal Rail Loads
<ul style="list-style-type: none"> Suppliers are required to provide a master bill of lading to the GM consolidation center. Consign the master bill to Walmart Stores Inc. The destination address on the master bill is required to be addressed to the Consolidation Dock. <p>Example: GMC 7100</p> <ul style="list-style-type: none"> Include all purchase order numbers for the total tender. Total number of cases, pallets/slips, cube, and weight by purchase order. Place bills in sequential order as loaded. Include the seal number on master BOL. Seal number on BOL is required to match the seal on the trailer or container without any hand-written amendments or alterations. 	<ul style="list-style-type: none"> Suppliers are required to prepare an individual bill of lading for each final destination address (example: Walmart DC 6092, Spring Valley, IL). Include number of cases, pallets/slips, cube, weight, department, and type by purchase order. Put all individual bills of lading for the POs on the load in one envelope and write "Deliver to CC XXXX" on the front. (XXXX represents the number designation for the consolidation facility, example: GMC 7100.) Attach the master bill of lading to the envelope. 	<ul style="list-style-type: none"> To avoid missing paperwork on intermodal rail loads, we require a packet containing all BOLs, including the master BOL, to be placed at the back of trailer (taped to the inside of the right-hand door) when shipping via rail. Place a temporary seal on the trailer. The temporary seal protects trailer integrity while waiting for pick-up. Prepare BOL packet with the final seal inside the packet. Driver arrives to pick up freight and sign all bills. Driver and someone from operations break the temporary seal, and either a supervisor or security guard tapes the packet inside the right-hand door of the trailer and re-seals with the final seal. Seal number on BOL is required to match the seal on the trailer or container without any hand written amendments or alterations.

Multi-Stop Pickup

- Multiple Suppliers may share a truck, called a Multi-Stop Pickup, to reduce transportation costs and also reduce Suppliers' "freight factor." Each Supplier is responsible for properly loading the trailer to accommodate multiple stops.
- Supplier is responsible for secure load/blocking in their product to ensure their product fits into the space requested during Request for Routing.
- Merchandise must be ready to ship on confirmed date of carrier appointment.
- See the next page** for more information on loading procedures.
- If product availability causes the incomplete shipping of a purchase order, it is the responsibility of the Supplier to revise the bill of lading to reflect the shipped quantity and ship the remaining cases prepaid to the destination of the purchase order.

Overflow

- If there is overflow resulting in the incomplete shipping of a PO or POs due to incorrect loading or improper keying during the routing request, enter a transportation portal ticket at <https://wal-marttransportation.na1.teamsupport.com> immediately.
- Suppliers are expected to utilize all available trailer space. Pictures of trailer and overflow <https://wal-marttransportation.na1.teamsupport.com> **required** to be included in the ticket.

Any additional freight costs for shipping the remaining POs to their final destination DC will be charged to the Supplier responsible for the overflow.

Consolidation Centers, Loading Procedures

Proper Loading Procedures

The figures below illustrate the importance of entering accurate cube information and successfully loading the freight on the trailer. When entering POs into Request for Routing, Walmart's optimization software expects to utilize trailer space from the floor up to the height of 8 feet.

Refer to the Walmart Transportation and Routing guide for more detail.

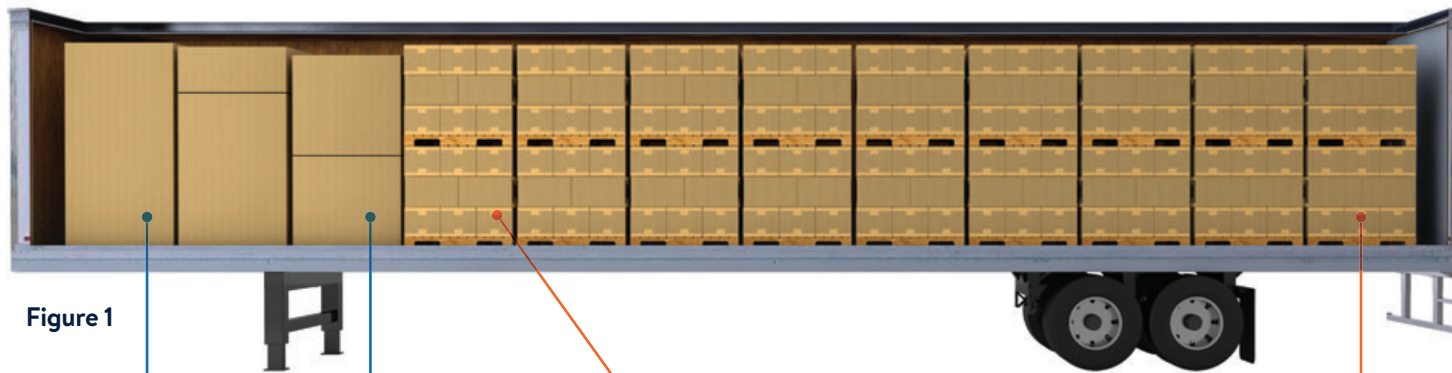

Figure 1

Figure 1 - Supplier 1 has entered their orders as Floor in RFR and fully utilized the space it has been allocated, allowing **Supplier 2** to fill the rest of the trailer with their palletized freight.

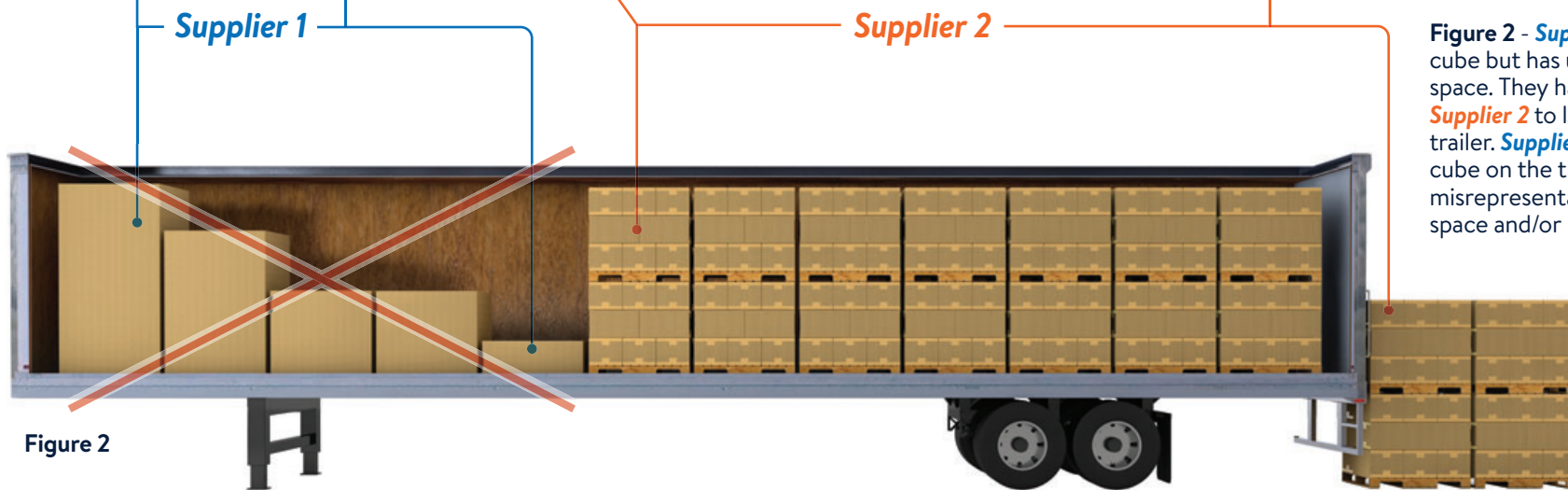

Figure 2

Figure 2 - Supplier 1 entered the same cube but has used significantly more space. They have made it impossible for **Supplier 2** to load all their pallets on the trailer. **Supplier 1** has rendered significant cube on the trailer as unusable through misrepresentation of needed trailer space and/or poor loading practices.

■ **NOTE - Use load securement to prevent product from shifting during transit.**

Consolidation Center Case Shipping Label

Case Shipping Labels

Suppliers shipping into the Walmart Consolidation Centers are **required** to include the information shown below on their case shipping labels. Walmart does not provide a template for this label or require a specific format for this label. It is the Supplier's responsibility to create the label.

A case shipping label is **required** on each case for all shipments into the GM Consolidation Centers (National PO's written to ACC/MCC* excluded).

Palletized shipments into the ACC/MCC* see the following page.

■ **NOTE** - See appendix A and B for FedEx and UPS small package labeling instructions.

The recommended size for shipping labels is 4" x 6" when including the barcode information but can vary with different sized boxes as needed. Standard shipping labels are **required** to contain the following:

REQUIRED	<ul style="list-style-type: none"> • Ship From Address: Suppliers address, city, state, zip code • Ship To Address: Walmart DC address, city, state, zip code • Destination Facility / Location # with minimum 3/8" character height: (Walmart DC number, e.g., 06094) 	<ul style="list-style-type: none"> • SSCC-18 Barcode in GS1-128 Format w/ appropriate application identifier • PO type: (PO TYPE, e.g., 0020) • PO number: 10 digits (ORDER #) • Walmart Item number: (WMIT)
OPTIONAL	<ul style="list-style-type: none"> • Department number: (Walmart DEPT number, e.g., 00013) • Expanded GLN Address (if available for the Ship To Address) 	<ul style="list-style-type: none"> • Carrier name (if available) • BOL number (if available) • Pro number (if available)

Label Placement (Individual Case)

Place case shipping labels left of center on the longest sides of the case if possible. If the height of the case does not allow, place the shipping label on the top of the case. If artwork or graphics printed on case do not allow for label placement left of center, alternative placement is acceptable.

Shipping Label and Barcode Verification

For support on shipping labels, Suppliers can email questions, concerns, and sample labels. Labels will be reviewed to ensure all the **required** information is on the shipping label and that the barcode scans in the correct format. We do not verify that the information on the label is correct. This is the Supplier's responsibility. Send correspondence to WBarcodeLabeling@walmart.com.

Ship From: Any Vendor Any Address City, State, Zip	Ship To: Walmart DC 6094A - ASM DIS City, State, ZIP code - GLN address Facility Location - 5 digits
CARRIER Carrier Name PRO: 1234567890 B/L: 1234567890	
DC# 6094	TYPE DEPT ORDER# 0033 00012 1234567890
WMIT: 001286123	
 (00) 0 0614141 123456789 0	

Shipping label
(example only)

SSCC18



■ **NOTE** - ACC/MCC Locations include DC# 6561, 7377, and 6938

Consolidation Center Pallet Shipping Labels

Pallet Shipping Labels

A pallet label is **required** when shipping unitized items to the Walmart Consolidation Centers. The pallet shipping label **requires** the same information as the case shipping label. The pallet label also **requires** the total number of cases on the pallet. Walmart does not provide a template for this label or require a specific format for this label. It is the Suppliers responsibility to create the label.

The **SSCC-18 barcode** is the **required barcode** format for all pallet labels.

A **Mixed Item pallet label** is **NOT ALLOWED** to contain the orderable GTIN in either **ITF-14** or **GS1-128** formats.

- If a unitized load is made up of one item, the label is **required** to list the Walmart item number below the purchase order number. If more than one item is on the pallet, the WMIT is **required** to read Mixed Pallet.
- Pallet labels are **required** on at least 2 adjacent sides of the pallet on the upper right side, preferably in between layers of stretch wrap.
- The use of SSCC-18 barcode does not negate the requirement of the orderable GTIN barcode at the case level.

REQUIRED	<ul style="list-style-type: none"> Ship From Address: Suppliers address, city, state, zip code Ship To Address: Walmart DC address, city, state, zip code Destination Facility / Location # with minimum 3/8" character height: (Walmart DC number, e.g., 06094) SSCC-18 Barcode in GS1-128 Format w/ appropriate application identifier 	<ul style="list-style-type: none"> PO type: (PO TYPE, e.g., 0020) Department number: (Walmart DEPT number, e.g., 00013) PO number: 10 digits (ORDER #) Walmart Item number: (WMIT) Qty of Cases on Pallet: (Pallet Label only)
	<p style="background-color: #0000ff; color: white; text-align: center; vertical-align: middle;">OPTIONAL</p> <ul style="list-style-type: none"> Department number: (Walmart DEPT number, e.g., 00013) Sequential Numbering of Pallets Expanded GLN Address (if available for the Ship To Address) 	<ul style="list-style-type: none"> Carrier name (if available) BOL number (if available) Pro number (if available)

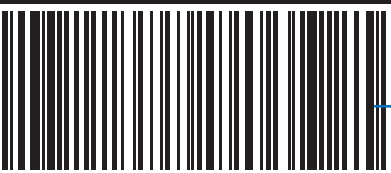
Ship From: Any Vendor Any Address City, State, Zip	Ship To: Walmart RDC 0000G 5841 SW Regional Airport Blvd Bentonville, AR 72712		
CARRIER Carrier Name PRO: 1234567890 B/L 1234567890			
GDC# 0000	TYPE 0033	DEPT 00012	ORDER# 1234567890
WMIT: 001286123			
# of cases: (48 cases)			
 (00) 0 0614141 123456789 0			

Single SKU pallet label

Ship From: Any Vendor Any Address City, State, Zip	Ship To: Walmart GDC 0000A - ASM DIS 5841 SW Regional Airport Blvd Bentonville, AR 72712		
CARRIER Carrier Name PRO: 1234567890 B/L 1234567890			
GDC# 0000	TYPE 0033	DEPT 00012	ORDER# 1234567890
WMIT: MIXED PALLET			
# of cases: (48 cases)			
MIXED PALLET			
 (00) 0 0614141 123456789 0			

Mixed pallet label



Pallet Shipping Labels – Pallet Pull / PDQ

Pallet Pull and PDQ Display Pallet Labels

A pallet label is **required** when shipping unitized items to the Walmart Consolidation Network. Walmart does not provide a template for this label or require a specific format for this label. It is the Suppliers responsibility to create the label.

The **SSCC-18 barcode** is the **required** barcode format for all pallet labels. In addition to the **SSCC-18 barcode**, the **14-digit case (orderable) GTIN** is **required** on the pallet label only when the item is a full Pallet Pull or PDQ Display.

- Pallet labels are **required** on at least 2 adjacent sides of the pallet, preferred on the upper right corner. It is best practice to place the label between layers of stretch wrap.
- Pallet Placards are **required** for both pallet pull and PDQ displays. See the Pallet Placards section of General Requirements for detail on pallet placards.



REQUIRED	<ul style="list-style-type: none"> Ship From Address: Suppliers address, city, state, zip code Ship To Address: Walmart DC address, city, state, zip code Destination Facility / Location # with minimum 3/8" character height: (Walmart DC number, e.g., 06094) 	<ul style="list-style-type: none"> SSCC-18 Barcode in GS1-128 Format w/ appropriate application identifier PO type: (PO TYPE, e.g., 0020) PO number: 10 digits (ORDER #) Walmart Item number: (WMIT) 14 Digit Supplier Pack (Orderable) GTIN Barcode: ITF-14 and/or GS1-128 (w/appropriate application identifier) format
	<ul style="list-style-type: none"> Department number: (Walmart DEPT number, e.g., 00013) Sequential Numbering of Pallets Expanded GLN Address (if available for the Ship To Address) 	<ul style="list-style-type: none"> Carrier name (if available) BOL number (if available) Pro number (if available) Qty of Cases on Pallet: (Pallet Label only)

Ship From: Any Vendor Any Address City, State, Zip	Ship To: Walmart GDC 0000A - ASM DIS 5841 SW Regional Airport Blvd Bentonville, AR 72712		
GDC# 0000	TYPE 0033	DEPT 00012	ORDER# 1234567890
WMIT: 001286123			
# of cases: (48 cases)			
 0 00 12345 67890 5			
PALLET PULL			
 (00) 0 0614141 123456789 0			

Pallet Pull pallet label

Ship From: Any Vendor Any Address City, State, Zip	Ship To: Walmart GDC 0000A - ASM DIS 5841 SW Regional Airport Blvd Bentonville, AR 72712		
GDC# 0000	TYPE 0033	DEPT 00012	ORDER# 1234567890
WMIT: 001286123			
# of cases: (48 cases)			
 [01]10847976000040[13]191120[10]ABC1234			
PDQ DISPLAY			
 (00) 0 0614141 123456789 0			

PDQ display pallet label

Consolidation Centers, Multiple POs per Pallet (MPP)

Why use MPP?

- Improved Cube Utilization
- Improved Accuracy
- Reduction in Handling

How to use MPP?

Email: logpkg@wal-mart.com
to verify eligibility.

See the following pages for requirements.

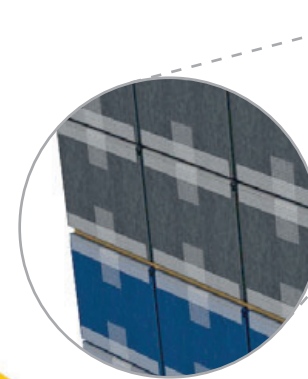

Use Tier Sheets
to separate
orders or items.

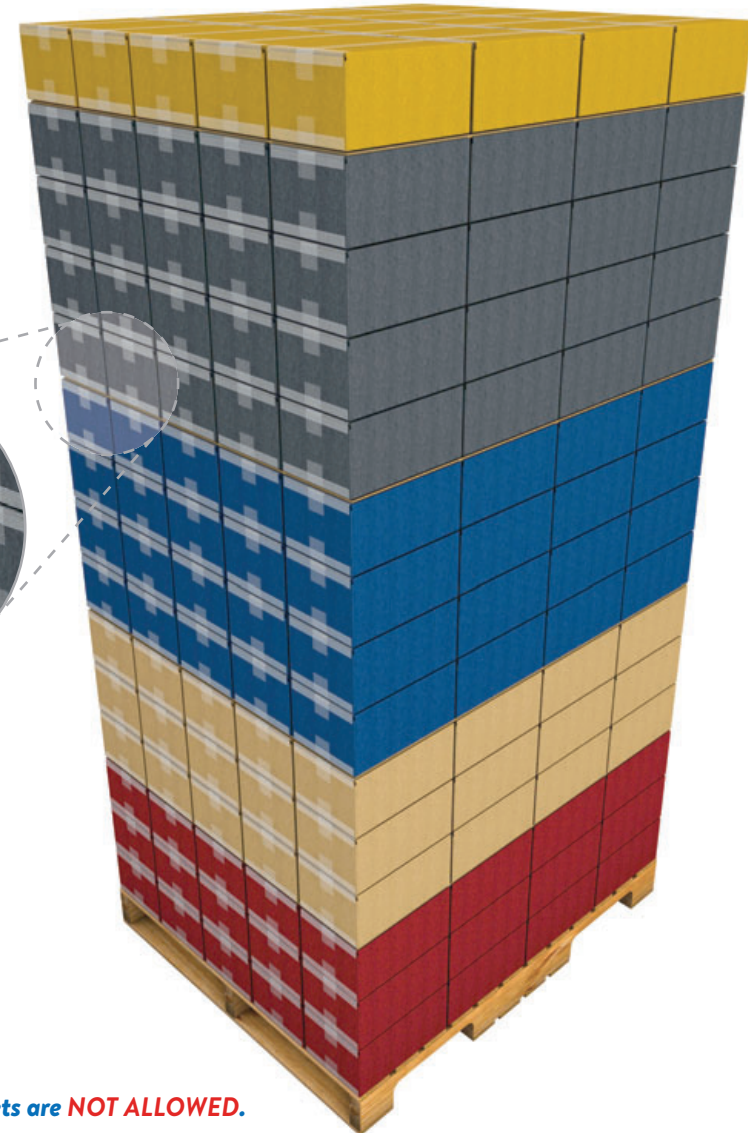

■ **NOTE - MPP-multiple destination pallets and slip sheets are NOT ALLOWED.**

BEFORE
Multiple POs on Multiple Pallets



AFTER
Multiple POs on One Pallet

Consolidation Centers, MPP Same Destination Pallet

Same Destination Pallet Requirements

- **When to use:** Suppliers with more than one department have orders with multiple POs for the same distribution center.
- Consolidation centers will not break down pallet. The entire pallet will ship to designated DC.
- Visible tier sheets are **required** to separate POs.
- BOL is **required** to have a pallet, case count, and weight for each PO.
- Cases are **required** to be individually labeled with a Walmart shipping label.
- PO TYPE
- You are **required** to use MPP placards. (See below.)
- Palletize orders in full layer or greater quantity.
- Configure pallets with flat tops to allow stacking of pallets.
- Small orders less than 1 layer should load as loose cartons in front of or on top of pallets in the trailer.

MPP Placard

- **Placard size:** 8.5" x 11"
- 1 placard is **required** on all 4 sides of every pallet grouping. The placard is **required** to be clearly visible to the unloader.
- **Required color:** Orange (PMS 165 C is preferred)
- **Font:** Arial Regular | **Font size:** 44pt. | **Font color:** Black
- DC Number is **required** to be **UNDERLINED**.
- List all POs and case counts combined on the pallet.

■ **MPP-multiple destination pallets and slip sheets are NOT ALLOWED.**

MPP placard
(example only)

MULTI PO SAME DC6092

POs
0123456789 - 20 CASES
3456789012 - 10 CASES
9876543210 - 15 CASES
6543217892 - 12 CASES

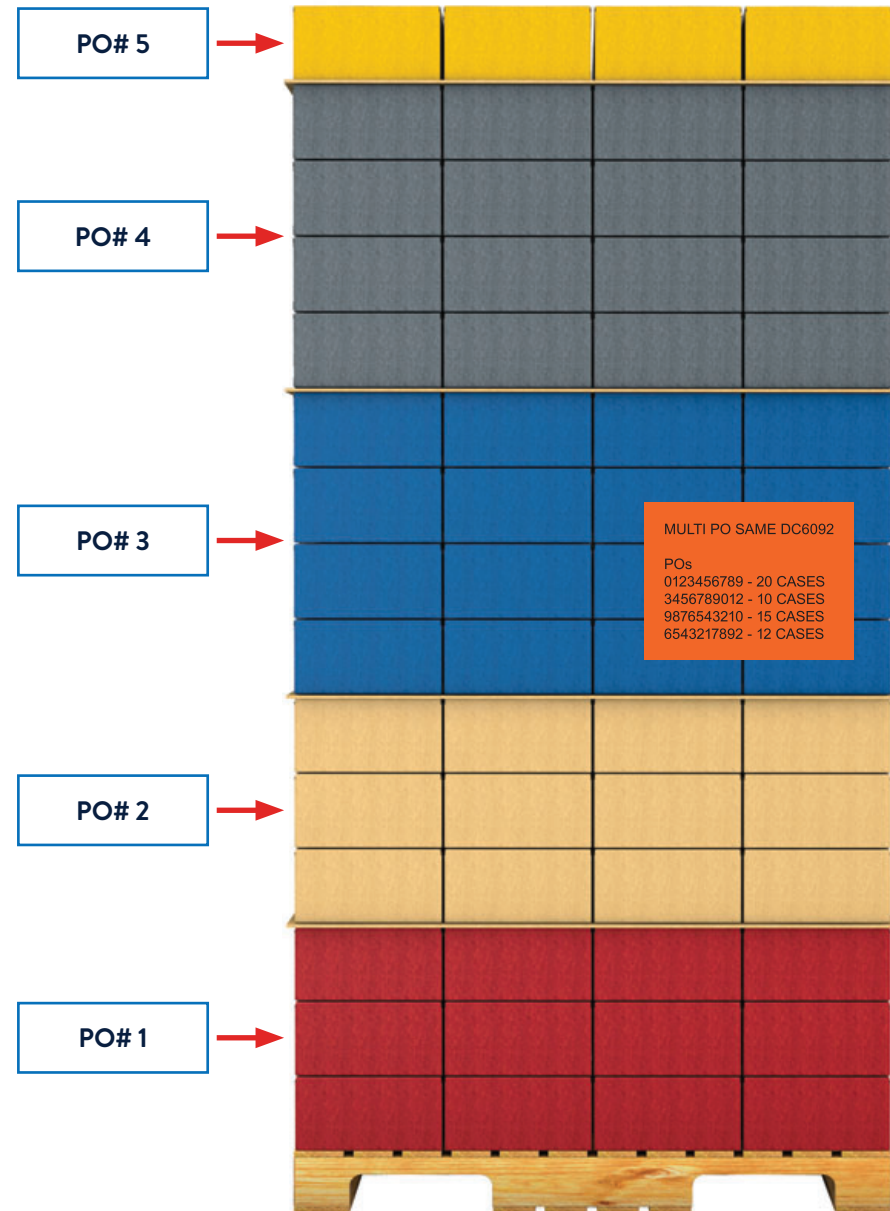

Consolidation Center, Order Unitization

Order Unitization

Some orders that ship into the consolidation network may not be large enough to ship as palletized freight. If a supplier has several small orders they may choose to unitize each order separately for delivery to the consolidation center. This method may not be used for any orders that create a full pallet layer or more of product. Please follow standard instruction for shipping those items. Unitized orders may be floor loaded to a trailer or placed loose onto a pallet for shipment to consolidation.

If you choose to use this method to ship your items, you are **required** to meet the following instruction:

- Unitized Orders must be smaller than a full pallet layer of product.
- Unitized Orders must consist of more than 1 carton of product.
- No less than 3 and no more than 5 layers of stretch wrap may be used on each Unitized Order.
- Pallet Shipping Label is **required** to be applied to each Unitized Order (Do not apply a pallet label to the full pallet if the unitized orders are placed on a pallet).
- If unitized orders are placed on a pallet, stretch wrap is **NOT ALLOWED** to secure the separate unitized loads to the pallet.
- Requirements for Master and Individual BOL's shown in this consolidation center section of the standards is **required** to be met.
- Unitized Order may not exceed 50 lb weight.
- Product cannot be configured on the pallet such that it falls over when moved with a forklift.
- Suppliers are **required** to properly block and brace all shipments to withstand the rigors of transportation from their ship point location to the DC.
- If placed onto a pallet the unitized orders must be capable of supporting a pallet stacked on top of it.
- If a unitized load consists of multiple PO's shipping to the same destination DC the supplier is required to use the same destination placard shown on the previous page.

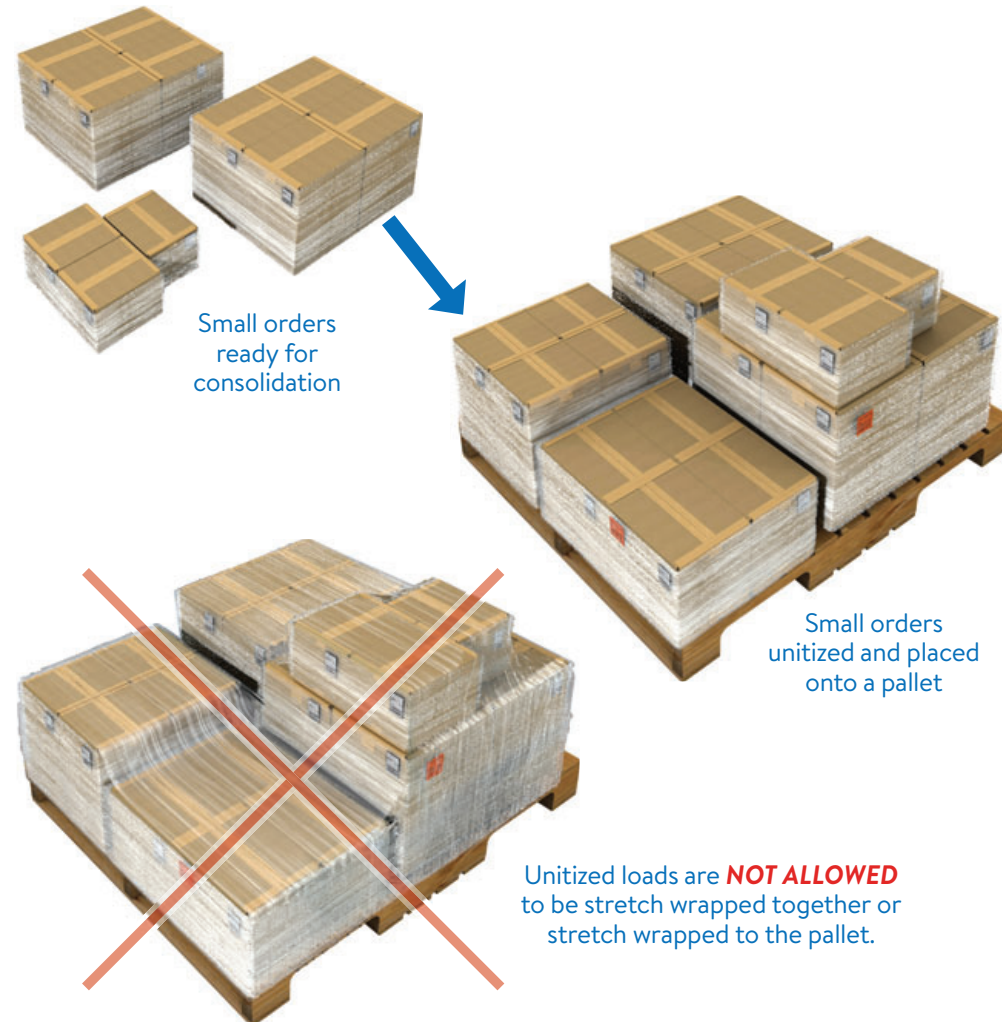

NOTE - This Instruction applies to shipments into GM Consolidation Centers (shipments to ACC/MCC may not use this instruction. ACC/MCC Locations include DC# 6561, 7377, and 6938).

NOTE -For additional questions and support please reach out to the Supplier Solutions Team at SSMailbox@walmart.com. You may want to reach out to this team to review your Ti-Hi, MOQ, and other order settings.

Walmart USA and Puerto Rico Case Markings

NOTE - These requirements are in addition to any other labeling **required** for shipping cases which also serve as retail packaging. Follow any additional packaging instructions from buyers, unless those conflict with instructions in this document or in the requirements below.

Import Supplier Guidelines for USA and Puerto Rico

Import Suppliers must follow the instructions for general merchandise case markings, pallet quality, footwear size-run markings, and general inner pack marking requirements found in the Case Markings section of the Walmart Supply Chain manual.

Walmart Shipments Only

This applies to direct import shipping case barcode labels for Walmart Puerto Rico, Walmart USA, and Walmart.com purchase order (PO) shipments only.

Direct Import Case Markings

All items that ship into the Walmart Import Distribution Centers are **required** to have a shipping mark applied to them. This shipping mark can be printed directly to the corrugated carton, applied with a label, or any combination of these 2 methods. Supplier can create their own labeling or, alternatively, may purchase approved labels from Avery Dennison (See Appendix F).

NOTE - For eCommerce only: When the vendor case quantity is equal to 1, meaning one selling unit is within its own shipping case, a UPC-A (GTIN12) or EAN (EAN13) formatted barcode is **required** on the outer case.

NOTE - For eCommerce only: When the vendor case quantity is greater than 1, a UPC-A (GTIN12) or EAN (EAN-13) formatted barcode is **NOT ALLOWED** on the outer case. For more detail, refer to the eCommerce section of this manual.

NOTE - For optical items shipped by sea to other PO destinations, the Supplier applies the direct import shipping case barcode label described in the Shipping Label section of this manual.

NOTE - For information on ITF-14 barcode size and quality requirements, see the ITF-14 Barcode section of this manual.

The following information is **required** on a minimum of one side of all shipping cartons:

REQUIRED	<ul style="list-style-type: none"> • Department number: Walmart DEPT number (Optical Dept. 49 is exempt from this requirement) • PO number: 10 digits (ORDER #) • Walmart item number: (WMIT) • Supplier stock number 	<ul style="list-style-type: none"> • Supplier pack (orderable) GTIN barcode in ITF-14 format (Must match information published to Item 360. If the PO lists the entire unitized load as a vendor pack, the barcode is only required at the pallet level.)
OPTIONAL	<ul style="list-style-type: none"> • Sequential numbering of cartons • Qty of items contained in carton • Brand/sub-brand name 	<ul style="list-style-type: none"> • Item description • Color/size/style • Country of origin



Walmart USA and Puerto Rico Case Markings, cont....

Lithium-Ion or Lithium Metal Batteries, Airfreight Shipments

- One of the major risks associated with the transport of batteries and battery-powered equipment is short circuit of the battery as a result of the battery terminals coming into contact with other batteries, metal objects, or conductive surfaces. Packaged batteries or cells are **required** to be separated in a way to prevent short circuits and damage to terminals. They must be packed in a strong outer packaging or contained in equipment.
- A Class 9 hazard label is **required** on at least one side, in addition to other **required** case markings for shipments containing lithium-ion or lithium metal batteries.
- Markings are **NOT ALLOWED** to be obstructed or covered by any other labeling.
- Labels are **NOT ALLOWED** to be folded over the edge of the shipping case.
- Cases that do not comply must be relabeled prior to shipping from a Walmart facility at the Supplier's expense.

Case markings must include:

**CARGO AIRCRAFT ONLY
FORBIDDEN IN
PASSENGER AIRCRAFT**



Additional guidance related to lithium batteries can be found on Walmart Retail Link at: [Docs > Global Direct Imports Information > Airfreight Procedures - Lithium Battery Airfreight Placard Example](#).

Become familiar with U.S. regulations for transporting lithium batteries at: www.gpo.gov/fdsys/pkg/FR-2014-08-06/pdf/2014-18146.pdf.



Example only

NOTE - Supplier is required to meet all regulatory markings for shipment and distribution of products.

Walmart USA and Puerto Rico Case Markings, cont..

Direct Import Case Marking Requirements

Walmart **requires** that, prior to inspection of the goods, Suppliers apply the direct import case markings or the Avery Dennison direct import shipping label to each shipping case (vendor pack in the Walmart PO) shipped to Walmart USA and Walmart Puerto Rico.

When using the direct import shipping label, Suppliers are **NOT ALLOWED** to change the labels in any way or make photocopies of the labels. Throw away all extra labels for each purchase order.

Direct Import Shipping Label Exceptions

Supplier applies the case labels, except for the following shipments:

- **High-value jewelry (Dept. 32)** shipped by air to Bentonville, AR; Marlow, OK; or New York, NY
- **Optical (Dept. 49)**
- **All sample products**
- **Fixtures (Dept. 75)** that are not being shipped to a Walmart import distribution center (IDC) or regional distribution center (RDC). The shipment comments in the Dept. 75 PO state whether a shipping case barcode label is **required**.



Direct Import Case Marking Placement

- Direct import case markings should be applied to the longest side of the case if space allows. If there is not enough room for the entire label, it may be applied to half top and long side (see example below).
- Walmart **requires** only 1 marking per case (more may be used).
- Placing the marking on the bottom of the case or over printed graphics on display cases is **NOT ALLOWED**.

Direct Import Case Marking Locations

The location of your case markings may vary because of other **required** case markings. This is acceptable as long as the marking or label (or bottom half of label) is applied to the long side of the case. No part of the label may be applied to the bottom of the case.

NOTE - Each PO may have different case marking requirements. If the Supplier applies additional markings or labels for the Supplier's own needs, this is acceptable as long as the additional markings or labels do not conflict with Walmart's requirements.

Walmart's own private label products must comply with Walmart's General Merchandise Case Marking requirements. Below are examples of possible markings and label locations.



Walmart USA and Puerto Rico Case Markings, cont..



Unitized Shipments

Apply the direct import shipping case barcode label to the transport packaging (the vendor pack in the Walmart PO).

- Shipping on pallets to the Walmart IDC is allowed only for specific programs or with special permission due to product requirements. Contact the Walmart Senior Packaging Manager at logpkg@wal-mart.com for more information.
- If the PO lists the **individual shipping cases as vendor packs**, then application of the direct import case markings on each case is **required**.
- If the PO lists the **entire unitized load as the vendor pack**, then the Supplier is **required** to apply the direct import shipping case label to the unitized load. If the unitized load is stretch-wrapped, apply the label to the outside of the stretch wrap.
- All unitized loads in stretch wrap **require** an additional domestic import shipping label be applied to the stretch wrap.
- **EXCEPTION:** If the unitized load is fully enclosed as one large case (covered with a corrugated shroud), apply one label to the unitized load, regardless of whether the PO lists individual shipping cases as the vendor pack.

Direct Import Case Marking Placement Exceptions

Some products (such as ready-to-assemble furniture) are commonly packed in tall/narrow retail packages which cannot stand up without support. If these retail packages are also the shipping case, the “sides” are effectively the top and bottom when inducted into automated facilities. When loaded on a pallet inside a shipping container, the shipping case will be loaded for stability first, therefore effectively hiding the sides.

If the Supplier places the case markings on one of the “sides,” they will not be visible when the cases are stacked for loading. For these situations, the Supplier can place the case markings on the end or top, as long as the case markings are facing outward when loaded.

Items Sold in Multiple Shipping Cases

If an item consists of parts that are shipped in separate shipping cases but are sold together as a single sales unit, the Supplier is **required** to place the direct import case markings, including the ITF-14 barcode, on only one of these cases. (Example: 5-pc table and chair set with table in one box, two chairs in a second box, and two chairs in a third box.)

The Supplier is **required** to clearly mark the Walmart Item Number on each carton and mark each package as part of the set. (Example - Box 1 of 3, Box 2 of 3, and Box 3 of 3.) All cartons from a set are **required** to ship on the same container.



Walmart USA and Puerto Rico Case Markings, cont...

Direct Import Slip Sheet Rules

- Slip sheets may only be used for storage orders on PO type 40 with warehouse number other than “0000” shown on the PO.
- Flow orders are **NOT ALLOWED** to be placed on slip sheets.
- If any side of your case is greater than 1,200 mm, it is considered an oversized case.
- **Auto Release:** Supplier may ship on a slip sheet with their own loading plan.
- Contact Global Logistics for approval if the cube usage is less than 85%.
- These guidelines do not cover orders with Retail Ready Packaging, including PDQ displays and SRPs (shelf ready packaging).

Golden Rule Flowchart

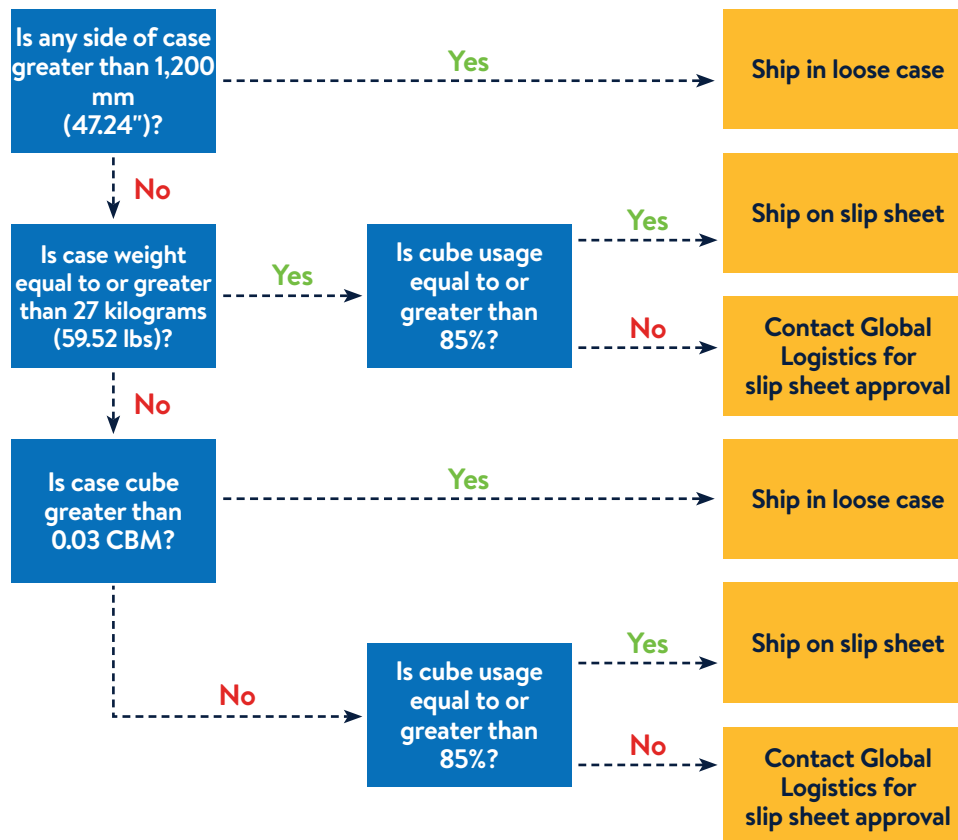

Direct Import Slip Sheet Construction

- Bandings, straps, twine, netting, and corner boards are **NOT ALLOWED**.
- Corner boards are acceptable for PDQ displays and RRP packaging.
- If Supplier is unsure of slip sheet stability without corner board usage, contact Walmart Global Logistics team for guidance. See next page for contact information.

Direct Import Slip Sheet Size

- Standard slip sheet footprint (excluding the lip) for imports to Walmart U.S. is 1,150 mm x 1,000 mm and the height is 1,300 mm max. or 1,150 mm max when non-HC container is used (45.27" x 39.37" x 51.181" max. height, or 45.27" when a non-HC contain is used).

- The standard slip sheet size is designed for 48 slip sheets to be loaded in a 40HC container, i.e., 2 wide x 2 high x 12 deep.
- Each slip sheet pack should have at least 1 lip, or ideally 2 or more, with 100–150 mm in depth (3.93"-5.9").
- Irregular slip sheet size can be requested but is subject to approval of Walmart Global Logistics team.

Direct Import Slip Sheet Loading Plan

- A single slip sheet is **required** to consist of one single item only; mixed items on one slip sheet are **NOT ALLOWED**.
- Slip sheet size is dependent on the dimensions of the cases loaded on it. The slip sheet loading plan should maximize the space of the stack, i.e., load as many cases as possible within the space of 1,150 mm x 1,000 mm x 1,300 mm (45.27" x 39.37" x 51.181").
- Always design slip sheet based on 1,150 mm x 1,000 mm x 1,300 mm first (45.27" x 39.37" x 51.181"). Only when cube usage is less than 85% may you use 1,150 mm x 1,000 mm x 1,150 mm (45.27" x 39.37" x 45.27").
- TI/HI for each item is **required** to be consistent. Using a different TI/HI on one slip sheet is **NOT ALLOWED**.

Direct Import Slip Sheet Stacking Weight

- Unitized load on the slip sheet is **required** to weigh less than or equal to 1,100 kgs.
- If there is concern on the use of fiberboard slip sheet, contact Walmart Global Logistics team for plastic slip sheet approval. See next page for contact information.

Walmart USA and Puerto Rico Case Markings, cont...

Direct Import Slip Sheet Container Loading

- One 40HC container can be loaded with 48 full slip sheets. It is **required** that 1,150 mm long side face the container door and the slip sheet lip is available to remove the unitized load.
- Large empty spaces between unitized loads are **required** to be filled with void fill materials (such as air bags or air pillows).
- Large empty spaces between unitized loads and container wall may be filled with loose cases or void fill materials.
- Loose cases are **NOT ALLOWED** to be placed on top of slip sheets.
- Netting or strings should be used as needed near the container door to prevent stack shifting or collapse.

European Region

European Global Logistics Team: gplouguk@walmart.com

Asia Pacific Region

US Execution Team, Global Logistics: glexeus@Walmart.com

Indian Sub-Continent

ISC Global Logistics Team: logmgrisc@wal-mart.com

Walmart USA and Puerto Rico Case Markings, cont..

Additional Markings for Walmart USA and Puerto Rico

For additional case marking requirements for Walmart USA private brand orders, refer to General Merchandise Store Case Labels and Markings section of this manual.

Some departments ask Suppliers to mark cases with colors to represent a category of merchandise. Colors may change from year to year. Color-coding may be at buyer's discretion. If buyer **requires** color-coding, this will be communicated to the Supplier at finalization.

For shipping cases which also serve as retail packaging, include all applicable retail case markings and labels.

The Supplier may include additional information on inner packs for internal use, but each inner pack will **require** the following information:

REQUIRED

- **Inner pack GTIN barcode in ITF-14 and/or GS1-128 (w/ appropriate application identifier) format** (Must match information published to Item 360. If a UPC-A or EAN-13 from the individual selling unit is visible through the packaging, the orderable GTIN barcode is not required.)
- **Product description**
- **Supplier stock number** (Must match information published to Item 360.)
- **Quantity of selling units (if pack size is greater than 1)**
- **Walmart item number** (**required** for Assortments only)
- **Store Case markings** (**required** for private brand items only)



- **NOTE** - For private brand cases too small for minimum case marking sizes, smaller marks are acceptable as long as the marks are legible for all items other than GTIN barcodes.
- For Bagged Produce items refer to "Palletized Shipments" section for additional information.

Walmart USA and Puerto Rico Case Markings, cont...

Case and Package Quality Guidelines

Walmart prefers automation eligible cases (cases that can move easily throughout the DCs automated systems).

Quality standards

For Walmart's case quality standards, refer to Case Quality section of this manual.

Case and packaging priorities

Direct import case and packaging requirements are in addition to domestic requirements. Where direct import requirements are an exception to domestic requirements, the direct import requirements take priority.

Automation Eligible

Walmart prefers automation eligible cases (cases that can move easily throughout the DCs on conveyors). Avoid using automation ineligible cases, including dimensions or weights which are under the minimum or over the maximum requirements.

Minimum requirements

6.4" L x 5.0" W x 2.0" H (minimum 1 lb.)
163mm x 127mm x 51mm (0.45 kg)

Maximum requirements

36" L x 24" W x 16" H (maximum 50 lbs.)
915mm x 610mm x 407mm (23 kg)

Additional Quality Standards for Direct Imports

- **Perforated cases** must withstand warehouse handling without damage to the case.
- **All liquids** must be marked **THIS SIDE UP** and shipped accordingly.
- **Hazardous material packaging** must comply with all ISPS requirements and all requirements set forth in the US Department of Transportation's hazardous material approval letter.
- **Bags** must be enclosed within a box.
- **A box with bands or straps** is automation ineligible and **requires** special handling at additional expense to the Supplier. See **Automation Eligible & Ineligible Cases** section of these standards for additional detail.

Master Case Markings

IMPORTANT - All shipments, whether delivered to the carrier or origin cargo manager, are **required** to have correct markings and appropriate shipping marks. The Supplier obtains necessary information from the PO. Any incorrect case marking results in re-marking of the case or inner box at the Supplier's expense. The fee is US \$1.00 per case.

Case and packaging priorities

- For case markings and case labeling of direct import shipping cases, these requirements take priority if the case serves only as a shipping case.
- If the case serves also as retail packaging, then any domestic retail packaging requirements are in addition to these shipping case requirements.
- The exception to the above rule is that specific requirements published by an individual department are in addition to the direct import shipping case requirements.

Case and Packaging Exceptions

For exceptions to case or packaging quality or markings requirements, contact the Walmart Global Sourcing (WGS) merchandiser or Walmart Direct Imports department import manager, depending on who sourced the goods.

NOTE - If the exporting country or air carrier requires banding or strapping, the Supplier does not need approval.

Jewelry Distribution - Overview

Jewelry DC Requirements

Suppliers shipping into the Walmart Jewelry DCs (JDCs) are **required** to adhere to all general case markings, case quality, and pallet standards as well as all Shipping and Routing Documentation Standards. The JDC processes small case, high-value items safely and efficiently for movement to stores.

Suppliers may also choose to use secured carriers for high-value shipments. These shipments must follow the shipping and routing protocols advised by the secured carriers and are **required** to maintain Walmart labeling standards.

Case Size Requirements

Suppliers shipping into the Walmart Jewelry DCs (JDCs) are **required** to pack their items in vendor packs that do not exceed the following dimensions:

Inbound Case Maximum Dimensions				
	Length (in.)	Width (in.)	Depth (in.)	Weight (lbs.)
Watches	24	14	9	40
Fine Jewelry	24	7.5	6.5	40

Packaging Requirements

Suppliers shipping to the JDCs will need to meet specific packaging requirements in order to keep our shipment processing secure and efficient.

- Each item is **required** to be individually poly bagged and placed into the bag of 50 loose.
- It is **NOT ALLOWED** to staple or otherwise secure individual poly bags to each other.
- All merchandise should be in vendor packs of 50 pieces, unless otherwise approved by the buyer.
- Individual 50 pieces are **required** to be placed into a larger ziplock bag. Do not substitute envelopes or other style bags for the ziplock bag.
- IGI certificates are **required** to be placed inside the individual bag with the item.
- Each 50-pack is **required** to have an information label placed on it. Using the information sticker to close the bag is **NOT ALLOWED** as it will be damaged when the item is inspected.



(sample)

- 1 - Purchase order number
- 2 - Supplier style number
- 3 - Walmart item number
- 4 - Supplier pack quantity
- 5 - Quote ID number

PO#:	4251399999
Style:	XYZ123
Item#:	XXXXXXXXXX
Qty:	150pcs
QID:	XXXXXXXXXX

Information Label Requirements

- Each vendor pack is **required** to have a packing list inside the box.
- Each case is **required** to be sequentially numbered if more than 1 case is being shipped per the PO. Example: Box 1 of 5, Box 2 of 5, Box 3 of 5, etc.
- Internal case dunnage is **required** to be bubble wrap or full sheets of paper.
- Styrofoam peanuts, shredded paper, and other dunnage is **NOT ALLOWED**.
- UPC tags on merchandise are **required** to be visible so items can be test scanned.
- Pendant tags are **required** to be left outside of the small envelope on the back of the pad so they are able to be scanned.
- All Gift Box Merchandise is **required** to be boxed.
 - Bagging this type of freight is **NOT ALLOWED**.
 - Information sticker is **required** on the short end of the box. Do not place it on the top of the box as it will get damaged when opened.

NOTE - For more information on Primary Packaging and UPC tags for jewelry items, see http://rl.homeoffice.wal-mart.com/marketing/packaging_toolkit.aspx.

Optical Distribution Centers

Optical DC Overview

- Optical DCs process freight in full pallet quantity, individual case quantity, and break pack quantity.
 - Optical DCs receive freight designated as vendor packs and break packs.
 - Receiving pallets are stored in a reserve location until needed for order fulfillment.
 - Completed store orders are shipped via small parcel carriers to Walmart Vision Centers.
- Optical DCs contracts 3rd-party carriers that utilize a hub-and-spoke network.
 - Suppliers shipping to the Optical Network are **required** to adhere to all General Merchandise case quality and industry/regulation marking standards as well as all Shipping and Routing Documentation standards.

Inner Pack Markings

Inner packs are warehouse packs that will be broken out and sent to individual stores by the DC. Inner packs are **required** to be properly secured so the single selling units do not come loose during the order fulfillment process. All Accessories, Contacts, and items other than Frames (with or without cases) must adhere to general inner case marking standards.

Walmart **requires** that Frames (with or without cases) meet the following requirements:

- Labels for frames are **required** to be 4" x 3".
- Labels for frames are **required** to be placed on the short side of the case (6.25").
- Labels for frames are **required** to include the following information:
 - Frame name
 - Item number
 - UPC barcode and human readable number
 - Color
 - Measurements
 - Quantity

Inner pack frame label (sample)

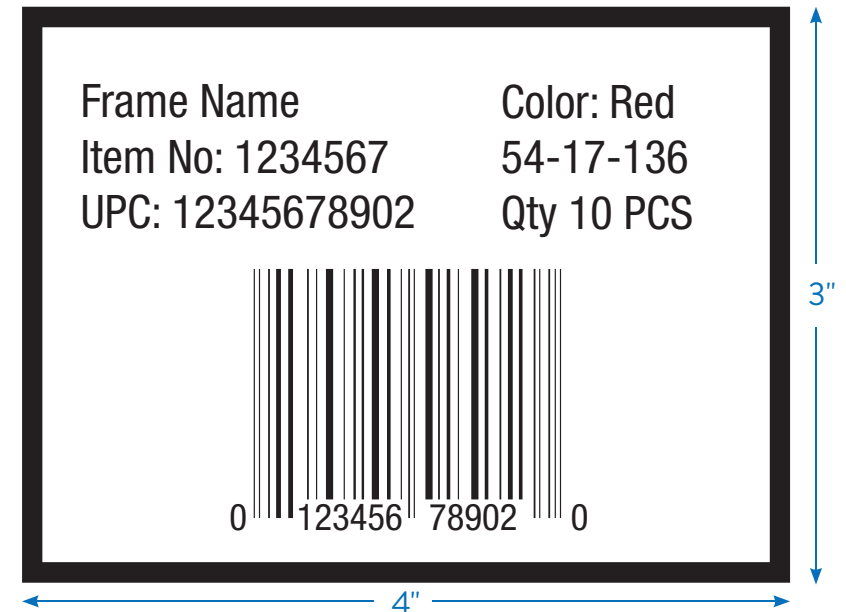

Optical Distribution Centers, cont...

Optical DC Required Frame Packaging

- Inner pack cartons for Frames are **required** to be constructed from one of the following materials:
 - Solid Bleach Sulfate (SBS)
 - Coated Unbleached Kraft (CUK)
 - Coated Recycled Paperboard
 - Uncoated Kraft Paperboard
- Inner pack cartons for Frames are **required** to be die cut in no caps except (TT)
- Paperboard/corrugated inserts are not required and are allowed if the Supplier is using them to ensure proper shipping.
 - If used, these inserts are not required to be printed.
- Frames are **required** to be packaged 10 per inner pack carton.
- UPC Tags are **required** to be placed on the earpiece of the frame.
 - The tag is **required** to wrap around the ear piece and stick together.
 - The wrap that touches the earpiece is **NOT ALLOWED** to be sticky.
 - The wrap that touches the earpiece is **required** to not slide on the frame.
- Plastic sleeves to hold the Frames
 - Ziplock bags are **NOT ALLOWED** except for the chassis frames or multiple pcs.
 - Placing sleeve over earpieces are not required if the frame is in a bag.

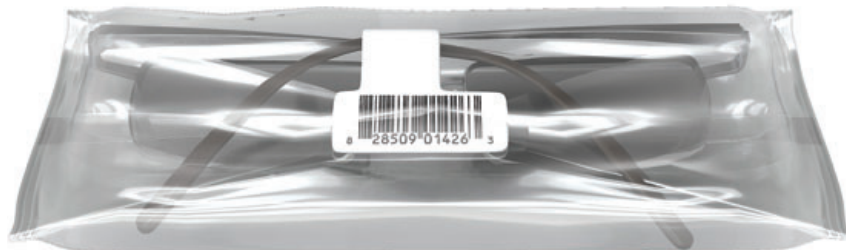

Frames with Cases:

- Frames with cases are **required** to have the following outside dimensions:
 - 6.25" W
 - Cartons with greater than 13" depth are **NOT ALLOWED**.

Frames without Cases:

- Frames without cases are **required** to have the following outside dimensions:
 - 6.25" W
 - 8.50" L
 - 4.25" D



Inner pack carton with label (example only)

Frame Testing:

To be compliant with FDA requirements on product control, Walmart has adopted 2015 ANSI standards for frame testing.

- 5.2.1.2 DBL dimension
- 5.2.1.3 Thickness of Eyewires
- 5.2.1.4 Eye Size (stamped vs. actual)
- 5.2.1.5 Inside Eye Shape and Circumference
- 5.3.0.0 Temple Measurements

Optical Distribution Centers, cont...

Optical DC Palletization

- Suppliers are **required** to meet Walmart Standard Pallet Requirements.
- Suppliers are **required** to meet Walmart General Pallet Labeling Requirements.
- Pallets are **NOT ALLOWED** to be greater than 72" tall including pallet (67" without the pallet).
- Suppliers are **required** to ensure all loads are scheduled with the Optical DC.
- Master packs are **NOT ALLOWED**.

See Pallet Label and Placards Section for more information on pallet labeling requirements.

See Pallet Standards Section for more information on pallet requirements.



Pharmacy Distribution Centers, Overview and Inner Packs

RxDC Overview

- RxDCs process freight in full pallet quantity, individual case quantity, and break pack quantity.
- Recommend all shipments be palletized.
- RxDCs only receive freight designated as Staple Stock (held in DC inventory).
- Receiving pallets are stored in a reserve location until needed for order fulfillment.

- Order fulfillment occurs via a pick-to-light or A-Frame system.
- Completed store orders are palletized, stretch-wrapped, and loaded onto outbound trailers.
- RxDCs contracts 3rd-party carriers that utilize a hub-and-spoke network.
- Suppliers shipping to the RX Network are **required** to adhere to all General Merchandise case quality and industry/regulation marking standards as well as all Shipping and Routing Documentation standards.

Inner Pack Markings

Inner packs are warehouse packs that will be broken out and sent to individual stores by the DC. Inner packs are **required** to be properly secured so the single selling units do not come loose during the order fulfillment process.

Walmart **requires** that each Prescription Drug lowest saleable unit is labeled according to the Healthcare Distribution Alliance (HDA) "Guidelines for Barcoding in the Pharmaceutical Supply Chain."

Applicable Rx products must also contain a 2D GS1 DataMatrix containing the DSCSA product identifier attributes (GTIN, no caps).

Inner Pack Structural Guidelines

- Inner packs are **required** to be able to be engaged as individual units to be picked and separated.
- Excess glue sticking out from closures is **NOT ALLOWED**.
- Rubber bands, paper-based sleeves, plastic sleeves are **NOT ALLOWED**.
- Glass, ceramic, and fragile items are **required** to be properly packaged to minimize the risk of damage throughout the supply chain.
- Corrugated dividers or partitions are **required** to eliminate glass-on-glass contact and prevent breakage.
- Padding on the bottom of the case is **required** to be sufficient to protect against bottom tray wear during transportation.

DSCSA serial unit label (example only)

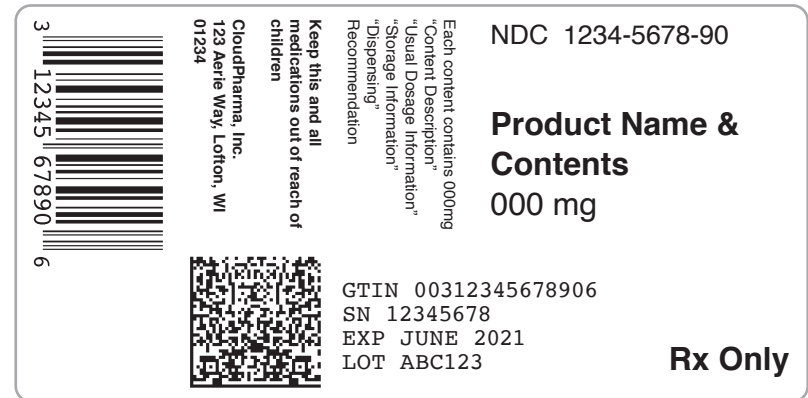

3 12345 67890 6

CloudPharma, Inc.
123 Aerle Way, Lofton, WI
01234

Keep this and all medications out of reach of children

Each content contains 000mg
"Content Description"
"Usual Dosage Information"
"Storage Information"
"Dispensing"
Recommendation

NDC 1234-5678-90

Product Name & Contents
000 mg

GTIN 00312345678906
SN 12345678
EXP JUNE 2021
LOT ABC123

Rx Only

OTC unit label (example only)



3 12345 67890 6

CloudPharma, Inc.
123 Aerle Way, Lofton, WI
01234

Keep this and all medications out of reach of children

Each content contains 000mg
"Content Description"
"Usual Dosage Information"
"Storage Information"
"Dispensing"
Recommendation

NDC 1234-5678-90

Product Name & Contents
000 mg

Pharmacy Distribution Centers, Case Labels and Markings

Case Label and Marking Guidelines

- Walmart **requires** that each Prescription Drug homogeneous case is labeled according to the Healthcare Distribution Alliance (HDA) "Guidelines for Barcoding in the Pharmaceutical Supply Chain."
- A combination of both GS1-128 and GS1 DataMatrix are **required** to be used at the homogeneous shipping case level.
- Homogeneous cases are **required** to unambiguously identify the product trade name, strength, GTIN, lot/expiration date, and quantity contained in the case.
- All refrigerated product is **required** to be clearly labeled and separated from ambient product.
- All cases containing fragile merchandise are **required** to be clearly marked with a graphic icon depicting the fragility of the merchandise.



Rx case
(example only)

- Online item file is **required** to reflect what is printed on the vendor case pack. Verify that the information printed on the case matches Walmart Retail Link.
- Product identification labels are **required** on a minimum of two adjacent sides on each case.
- Use a wraparound label or use two separate but identical labels on adjacent sides.
- Once the label is affixed to the case, ensure that there is a sufficient barcode "quiet zone" in the center of the label and that the barcodes on both halves are readily scannable.
- Case labels should be no closer than 1.25" from the bottom of the case.
- Affixing a case label to the top or bottom of the case is **NOT ALLOWED**.

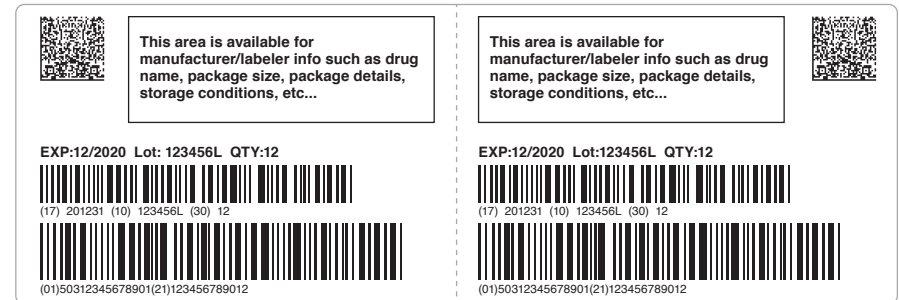

Rx serialized homogeneous case label (example only)

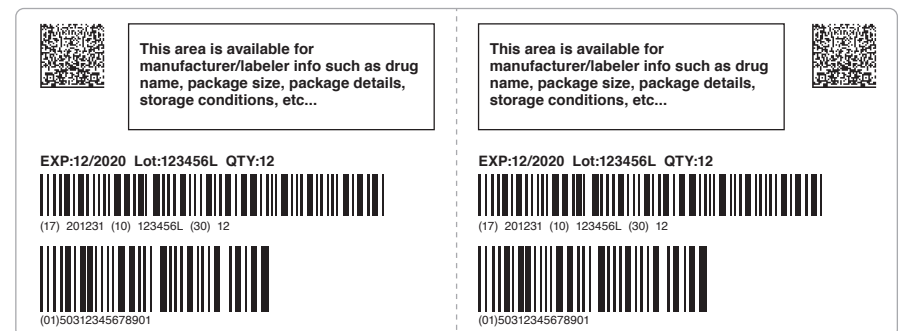

Non-serialized (OTC) homogeneous case label (example only)

Pharmacy Distribution Centers, Shipping Label and Packing List

Shipping Label Guidelines

- Walmart RxDC **requires** that a Serialized Shipping Container Code (SSCC) label is affixed to each individual shipping mix case or pallet.

Standard shipping labels are **required** to contain the following:

- Ship from address: Supplier's address, city, state, and zip code
- Ship to address: Walmart DC address, city, state, and zip code
- To postal barcode (optional)
- Carrier name (if available)
- Pro number (if available)
- BOL number (if available)
- Facility/location (5 digits)
- Walmart DC number, e.g., 06001
- PO number (10 digits)
- Walmart item number (WMIT)
- NDC number or "MIXED" if case or pallet has mixed SKUs
- Quantity – number of cases contained on the pallet
- GS1-128 barcode containing an 18-digit SSCC code

FedEx and UPS Labeling:

- The Walmart PO number is **required** to be provided.



Packing List

- Required** to be attached to the outside of the last box/pallet loaded on the trailer.
- Required** to be facing outward on the pallet or box in clear view of the unloader.
- A second packing slip should be made available to the carrier with the BOL and the freight bill for presentation at the warehouse receiving area.
- If shipping LTL, a packing slip is **required** to be attached to the outside of one case for each purchase order.

The packing list is **required** to contain the following:

- PO number
- Ship to name and address
- Shipper's name and address
- Product name, strength, dosage form, container size
- National Drug Code (NDC)/Supplier stock number
- Lot number
- Case count per item
- Total case count shipped

Each pallet, with either mixed products or purchase orders, is **required** to have a container list identifying the POs, items, and quantities on that pallet.

Ship From: Any Vendor Any Address City, State, Zip	Ship To: Walmart DC 6001 2252 N 8th St. Rogers, AR 72756
Ship to POSTAL CODE (420) 72756 	CARRIER Carrier Name PRO: 1234567890 B/L: 1234567890
Purchase Order#: 1234567890 Carton# 1 of 5	WMT Item# NDC: 00000 QTY: 00
SSCC: (00) 0 0000000 00000000 0 	

Shipping label
(example only)



Packing list - Facing outward
in clear view of unloader.
(example only)

Goods Not For Resale (GNFR)

GNFR Shipping Labels

Goods not for resale include fixtures, displays, non-working displays (NWD), signage, and other equipment that is not available for sale to customers inside our stores.

Shipping Label Requirements

- Shipping label is **required** to have a yellow background with black printing.
- Shipping label is **required** to be 4" x 6".
- Shipping label is **required** in the upper left corner of the case on the longest side of the case.
- If this location is awkward or otherwise not possible, it may be applied in a location that is convenient for viewing and processing.
- Adhesive is **required** to be capable of adhering to an applied surface for a minimum of 6 months in an ambient environment.
- Label printing is **required** to not fade for a minimum of 6 months in an ambient environment.
- Barcode is **required** to be in either CODE 39 or CODE 128 format and meet or exceed ANSI standard print grade B. The barcode will represent the SAP# assigned the item.
- For items that the SAP# has not been assigned, Supplier is **required** to use the description "FIXTURE", "DISPLAY", "SIGNING", or "OTHER" in 32 pt. font in place of the SAP# and SAP barcode.

Ship From: Any Vendor Any Address City, State, Zip	Ship To: Walmart DC Address City, State, ZIP code - GLN address Facility Location - 5 digits		
POSTAL CODE (420) 72712 	CARRIER Carrier Name PRO: 1234567890 BOL: 1234567890		
DC# 6094	TYPE 0033	DEPT 00012	ORDER# 01234567890
WMIT: 001286123			
 1234567890P			

Shipping label
(example only)

39 or 128 barcode



Place shipping label
left of center on
longest side.

REQUIRED	<ul style="list-style-type: none"> • Ship from address: Supplier's address, city, state, zip code • Ship to address: Walmart DC address, city, state, zip code • Facility/Location - 5 digits (Walmart DC number, e.g., 06094) 	<ul style="list-style-type: none"> • PO number - 10 digits (ORDER #) • CODE 39 or CODE 128 barcode representing SAP#
OPTIONAL	<ul style="list-style-type: none"> • Postal barcode • Carrier name (if available) • Expanded GLN address 	<ul style="list-style-type: none"> • BOL number (if available) • Pro number (if available)

Cold Chain Compliance Requirements

Program Purpose

- To maximize efforts to ensure uniformity in temperature reporting and measurement throughout Walmart's cold chain network for specific commodities.
- To enable electronic record keeping for temperature data on inbound shipments to Walmart facilities.
- To provide Walmart Suppliers the capability to receive temperature data on loads experiencing temperature excursions from the technology vendor (Emerson).

Program Implementation

- All fresh produce, meat, seafood, and floral Suppliers are **required** to utilize Emerson GO wireless temperature recorders on all pre-cooled inbound shipments to our food distribution centers, food import centers, fresh solution centers, and food cross docks.
- This program does not include frozen, dairy, or deli at this time but may include these commodities in the future.

Process Changes

- The intent of this program is to transition all Suppliers currently using temperature recorders to the Emerson GO Wireless recorder.
- This program does not mandate Suppliers to begin using temperature recorders where they are not currently required.
- HACCP product **requires** 1 Emerson Go Wireless temperature sensor per PO.
- Meat, Produce, and Floral product **requires** a minimum of 1 Emerson Go Wireless temperature sensor per trailer.
- On mixed product loads (HACCP and other commodity), HACCP temperature sensor will count as trailer level requirement.

NOTE - For more information contact CargoSupport@Emerson.com or call (877)988-7299.

Refer to the Temperature receiving chart in Appendix D for required receiving temperature.

Program Execution

- Temperature recorders must be accompanied by orange "Temperature Monitoring" placards (inserts) supplied by Emerson to indicate the location of each recorder.
- Place placard with sensor on face of pallet, 2-3 feet down from top, on the right or left side away from chutes discharge area.
- Do not place sensor on trailer wall, and avoid placing sensor facing trailer door on the tail of the trailer.
- Avoid placing sensor horizontally on top of pallet.
- All temperature recorders placed on inbound shipments are **required** to be linked to their corresponding PO# in Emerson's system (see instructions, demonstrations, and the Emerson Portal at <https://climate.emerson.com>).



Temperature monitoring placard with recorder (example only)

Temperature Monitoring

Logger# _____

Load Date: _____ Load Time: _____ AM/PM

PO/SO: _____

Receive Date: _____ Load Time: _____ AM/PM

Location: _____



Egg Packaging and Case Labels

Egg Case Label

The Egg case label provides industry standard data to speed the inventory flow of eggs though the supply chain. The information on the label is **required** to be both scannable and readable. Use of the Egg case label replaces general case marking requirements.

The Egg case label format and size are **required** to meet the standards shown in the graphics on this page. Placing one label over another is **NOT ALLOWED**.

Additional Markings for Meat and Poultry

All Egg shipments for Dept. 90 are **required** to include the following information:

REQUIRED	<ul style="list-style-type: none"> • Vendor of record name, address, and phone number 	<ul style="list-style-type: none"> • Case pack size and quantity: Must include the total quantity of selling units and individual units within the case.
	<ul style="list-style-type: none"> • Best by date • Brand name and product description: Count, size, grade, and the word "EGG" are required in ALL CAPS. • Keep refrigerated statement 	<ul style="list-style-type: none"> • Shipping container stock number: The last 5 digits of the item UPC with no check digit • Julian date and plant number • 14 Digit Supplier Pack (Orderable) GTIN Barcode: ITF-14 and/or GS1-128 (w/appropriate application identifier) format

Egg Case Label Location

A minimum of 1 Egg case label is **required** on the short side of each carton or RPC. This label is **required** to be visible from at least 1 side of the pallet when palletized. Additional labels may be placed on any other side of the carton.

Egg Case Selling Units

Egg cases that flow through the distribution centers to the stores in the same carton that will be sold to the customer are **required** to have the Julian date, plant number, best by date, and product barcode printed or applied to the front of the case. The product barcode may be in UPC-A, ITF-14, or GS1-128 format with appropriate application identifiers. This information is **required** to be visible on at least 1 side of the pallet when palletized. If you choose to use the ITF-14 or GS1-128 format barcodes, the UPC-A format barcode is still required at another location on the outside of the case for point of sale use at the store.



Each Shipping Label Must Be Clearly Identified With:

- (A) Julian date and plant number
- (B) Shelf life (as described in Exhibit II, Section 3)
- (C) Shipping container stock number (the last 5 digits of the item UPC, no check digit)
- (D) Brand name and product description (must include count, size, grade, and the word EGG)
- (E) 14 Digit Supplier Pack (Orderable) GTIN Barcode: ITF-14 and/or GS1-128 (w/appropriate application identifier) format
- (F) Shipping container net quantity - must include the total quantity of the contents of the case, the number of individual units, and quantity of each individual unit. (EXAMPLE: Case Pack: 15 / 1 DOZEN UNITS)
- (G) Name AND address of vendor of record accompanied by a qualifying phrase that states the firm's relation to the product, e.g., "Manufactured for" or "Distributed by." (EXAMPLE: Distributed by CCF Brands, Rogers, AR 72758, (479) 464-0544).

■ **NOTE - The requirements on this page apply to fresh egg shipments only.**

Egg Pallet Build Requirements

Egg Case Pallets

Suppliers are **required** to meet Walmart Pallet Quality and Perishable Labeling standards. See the appropriate section of these standards for more detail.

- On corrugated cases the label is **required** on a minimum of 1 side of the case. Additional labels, including wraparound labels, may also be used.
- On RPCs, the label may be located on a side of the RPC that is most suitable for label placement.
- Freezer-grade, permanent, rubber-based adhesive or equivalent is **required**.
- Case labels are **required** to be outward facing on a minimum of 1 side when palletized.

Pallet Label and ASN Barcode

The pallet label, along with the ASN GS1-128 SSCC-18 barcode, aids in a faster receiving process and better inventory management. Contact the Walmart EDI help desk for ASN onboarding. Pallet labels are **required** on two adjacent sides of the pallet. Please reference the Pallet Label Section of this manual for specific label requirements.

Code Dates and Pallet Build

The code dates of eggs contained on each pallet are **required** to be within 1 day of each other, and the oldest eggs must be on the top layers of the pallet. Low-volume products such as Medium and Twin six-pack eggs are exempt from the 1-day requirement. Mixed-date pallets are **required** to be clearly identified with an 8.5" X 11" placard on all 4 sides of the pallet with the text "Mixed Date Pallet."

It is the Supplier's responsibility to ensure that pallets are stable. Pallets are **required** to contain vented or non-vented stretch wrap in a bow tie fashion. Unrestricted air flow is **required** for egg quality. Plastic bands and corner boards may be used as needed. Consumer 60-count packaging is **required** to be wrapped with corner boards.



■ **NOTE - Overhang no greater than 1" is allowed for palletized egg shipments.**

■ **For additional details on egg requirements, including regulatory compliance, audit requirements, and other information, please contact your buyer for the Best In Class: Fresh Shell Egg Program document.**

Meat/Poultry Items

Meat and Poultry Case Label

The Meat and Poultry case label provides industry standard data to speed the inventory flow of meat and poultry products through the supply chain. The information on the label is **required** to be both scannable and readable. Use of the Meat and Poultry case label replaces the requirement of general case markings.

For industry information and standards specifications such as label size and formatting, refer to www.gslus.org, *North American Industry Guidance for Standard Case Labeling*.

Additional Markings for Meat and Poultry

All meat and poultry shipments for Dept. 93 are **required** to include the following information:

REQUIRED	<ul style="list-style-type: none"> • Product description • Date (<i>Packaging, Sell By, or Scale By</i>) • EST number (<i>USDA inspected product only</i>) 	<ul style="list-style-type: none"> • Net weight • Inspection stamp • GS1-128 barcode: Barcode is required to include Supplier pack (orderable) GTIN, batch/lot number, and appropriate application identifiers. Other information is optional.
OPTIONAL	<ul style="list-style-type: none"> • Supplier name • Supplier stock number • Supplier ID # • PLU # 	<ul style="list-style-type: none"> • Walmart item number (WMIT) • Safe handling instructions • Selling unit UPC barcode

NOTE - The requirements on this page apply to all fresh or frozen Meat/Poultry items in Department 93 only. Items that are not fresh or frozen meat or poultry are required to meet the General Case Marking standard published to this guide.

Refer to the Temperature receiving chart in Appendix D for **required** receiving temperature.

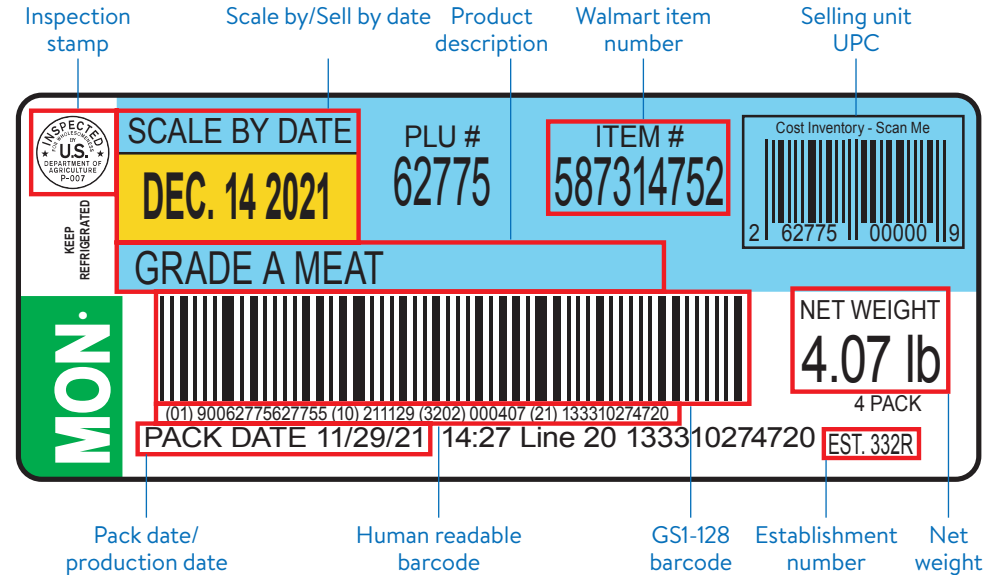

Seafood Items

Fresh Seafood Packaging

Fresh Seafood is **required** to be packaged in fully sealed packaging. The use of fully sealed packaging prevents the chance of contamination of packaging equipment, materials, and other items within the Walmart supply chain.

Fresh Seafood Case Label

The Seafood case label provides industry standard data to speed the inventory flow of seafood products through the supply chain. The information on the label is **required** to be both scannable and readable. Use of the Seafood case label replaces the requirement of general case markings. If you are not able to supply the GS1-128 barcode, the orderable GTIN in ITF-14 format is acceptable as long as the batch/lot number is printed on the label in a human readable format.

For industry information and standards specifications such as label size and formatting, refer to www.gs1us.org, *North American Industry Guidance for Standard Case Labeling*.

All seafood shipments are **required** to include the following information:

REQUIRED	<ul style="list-style-type: none"> • Supplier name • Product description • Lot number • Sell by date/Best by date • Country of origin 	<ul style="list-style-type: none"> • Net weight: (fresh Seafood only) • GS1-128 barcode: Barcode is required to include supplier pack (orderable) GTIN, batch/lot number, and appropriate application identifiers. Other information is optional. ITF-14 barcode may be used in place of the GS1-128 barcode if the lot number is printed on the label.
OPTIONAL	<ul style="list-style-type: none"> • Walmart item number (WMIT) • Selling unit UPC-A 	<ul style="list-style-type: none"> • Supplier ID # • Supplier stock number

NOTE - The requirements on this page apply to all fresh or frozen Seafood items in Department 93 only. See General Case Markings section of this guide for additional details on private branded frozen Seafood packaging.

Refer to the Temperature receiving chart in Appendix D for required receiving temperature.

All Seafood labels/carton markings are required to use the GS1-128 barcode no later than 1/1/2024. ITF-14 format will no longer be accepted after this date.

All Seafood must be in fully sealed packaging no later than 7/1/2024.

Species Farmed in State, U.S.A.	Net Weight	Packaging
Atlantic Salmon Fillet	37.40 LBS	2020-06-29
Pin-Bone In - Skin On	Gross Weight	Batch Lot No.
	17.10 Kg	12345
Quality	Walmart Item #	Selling Unit UPC
Trim A	12345	12345
Size	<i>Company Name, Inc.</i>	
2-3		
Nature identical	(01) 23456789001234 (56) 789001 (23) 45678	
Color added	Unit/PL - 16/28	
	Keep Cool -1° + 4° C	

Fresh Seafood label
(example only)

Frozen Seafood Case Markings

Required markings for Frozen Seafood may be printed directly to the carton or applied via a printed label. If applying a label to the carton, the background color of the label is **required** to be white, with the exception of thaw and sell items. Thaw and sell items may have a white or yellow background (as shown in the example below). If using a yellow background for thaw and sell items, it is **required** to be printed with PMS 102 yellow on the top 2.5" of the label.

Single label or wraparound labels are acceptable.

FOLD	
<p>MANUFACTURER LOGO/NAME</p> <p>PRODUCT NAME</p> <p>SECOND LINE (IF NEEDED)</p> <p>METHOD OF CATCH, COUNTRY OF ORIGIN BEST BY: MM/DD/YYYY</p> <p>ITEM # LOT CODE:</p> <p>SUPPLIER ID# PLANT CODE:</p> <p>XX UNITS/XX OZ EACH NET WT XXLB (XX KG)</p> <p> (00) 0 0614141 123456789 0</p> <p>DISTRIBUTED BY: DISTRIBUTER NAME CITY, STATE, ZIP</p> <p>KEEP FROZEN</p> <p> 21 62775 11 00000 19</p>	<p>MANUFACTURER LOGO/NAME</p> <p>PRODUCT NAME</p> <p>SECOND LINE (IF NEEDED)</p> <p>METHOD OF CATCH, COUNTRY OF ORIGIN BEST BY: MM/DD/YYYY</p> <p>ITEM # LOT CODE:</p> <p>SUPPLIER ID# PLANT CODE:</p> <p>XX UNITS/XX OZ EACH NET WT XXLB (XX KG)</p> <p> (00) 0 0614141 123456789 0</p> <p>DISTRIBUTED BY: DISTRIBUTER NAME CITY, STATE, ZIP</p> <p>KEEP FROZEN</p> <p> 21 62775 11 00000 19</p>

Frozen Seafood label
(example only)

Meat/Poultry/Seafood Case and Pallet Labels

Meat/Poultry/Seafood Case Label

A minimum of 1 label is **required** to be located on all shipments of Meat, Poultry, and Seafood for Dept. 93.

- On label the label is **required** to be located on a minimum of 1 side of the case. Additional labels, including wraparound labels, may also be used.
- On RPCs, the label may be located on a side of the RPC that is most suitable for label placement.
- Freezer-grade, permanent, rubber-based adhesive or equivalent is **required**.
- Case labels are **required** to be outward facing on a minimum of 1 side when palletized.

Pallet Label and ASN Barcode

The pallet label, along with the ASN GS1-128 SSCC-18 barcode, aids in a faster receiving process and better inventory management. Contact the Walmart EDI help desk for ASN onboarding. Pallet labels are **required** on two adjacent sides of the pallet.

NOTE - The requirements on this page apply to all fresh or frozen Meat/Poultry/Seafood items in Department 93 only. See General Case Markings section of this guide for additional details on frozen Seafood packaging.

- See Pallet Label and Placards section for more information on pallet labeling requirements.



Produce Case Label - Produce Traceability Initiative (PTI)

PTI Case Label

The PTI case label provides industry standard data to speed the inventory flow of highly perishable products through the supply chain. The information on the PTI must be both scannable and readable. Use of the PTI label replaces the requirement of general case markings. You are **required** to use the GS1-128 barcode on the PTI label. Use of the PTI case label for items other than produce within Dept. 94 is allowed, but not recommended. Use of the PTI label outside of Dept. 94 is **NOT ALLOWED**.

Additional Markings for Produce

All produce shipments for Dept. 94 are **required** to include the following information:

REQUIRED	<ul style="list-style-type: none"> • Packer information • Product description • Net weight • Country of origin 	<ul style="list-style-type: none"> • GS1-128 barcode: Barcode is required to include Supplier Pack (Orderable) GTIN, harvest, pack, or sell by date, lot number, and appropriate application identifiers. • Voice pick code
	<ul style="list-style-type: none"> • Harvest date for fresh produce -OR- • Sell by or pack date for pre-packed/processed items 	<ul style="list-style-type: none"> • Consumable GTIN UPC barcode for pre-pack items -OR- • PLU number for bulk items
OPTIONAL	<ul style="list-style-type: none"> • Walmart item number (WMIT) • Handling instructions 	<ul style="list-style-type: none"> • Additional regulatory information

ASN/EDI Requirements for Produce

Produce Suppliers are **required** to submit a Walmart Perishable ZZZZ compliant Advance Ship Notice (ASN) through EDI. The Walmart Perishable ZZZZ ASN provides advanced visibility to incoming shipments and clearly identifies it as produce. For industry information and standards specifications such as label size and formatting, refer to www.gs1us.org and www.producetraceability.org.

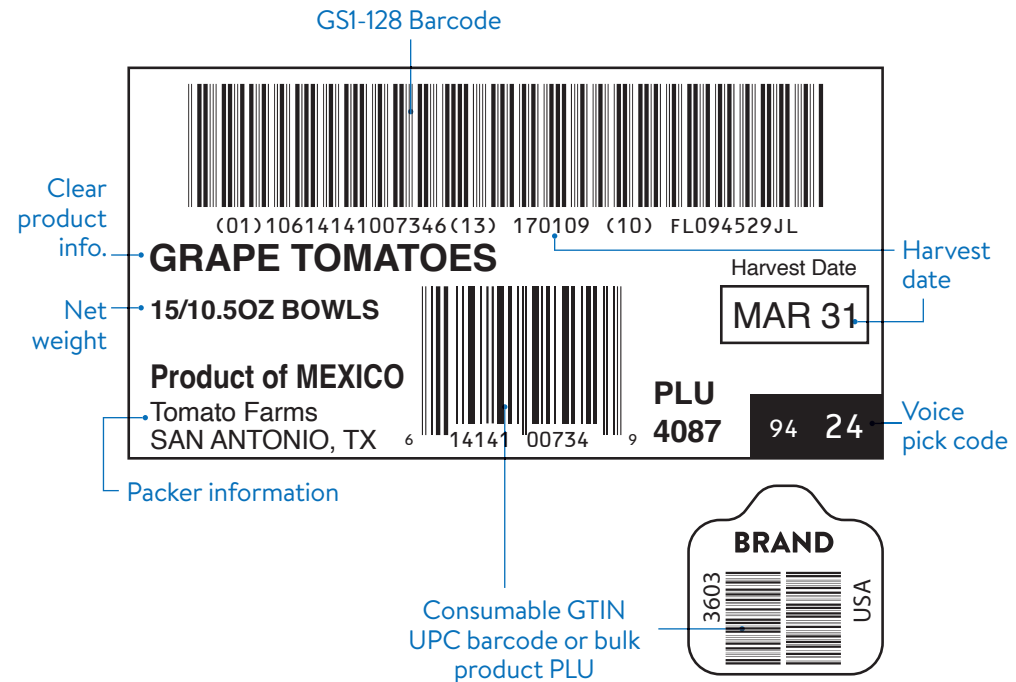

- **For questions regarding PTI labels, contact wmbarcodelabeling@walmart.com.**
- **GS1-128 barcode is required to meet size and print quality standards as referenced in the GS1-128 section of this publication.**
- **For more information on the Walmart Perishable ZZZZ Compliant ASN, see Walmart Retail Link: [Retail Link > Apps > Filter Docs "ED" > EDI-B2B > Guides > Perishable ASN.](#)**

Produce Pallet Label - PTI

PTI Case Label

The pallet label, along with the h barcode in GS1 format associated with your Walmart Perishable ZZZZ ASN, aids in a faster receiving process and better inventory management. Pallet labels are **required** on two adjacent sides of the pallet. PTI labels are **required** to be outward facing on a minimum of 1 side when palletized.

REQUIRED	<ul style="list-style-type: none"> • Ship from address: Supplier's address, city, state, zip code. • Ship to address: Walmart DC address, city, state, zip code • Facility/location # (Walmart DC number, e.g., 06094). 	<ul style="list-style-type: none"> • PO number: 10 digits (<i>ORDER #</i>) • Department number (Walmart <i>DEPT</i> number, e.g., 00013) • SSCC-18 barcode in GS1-128 format
OPTIONAL	<ul style="list-style-type: none"> • Sequential numbering of pallets • Expanded GLN address (if available for the ship to address) 	<ul style="list-style-type: none"> • Carrier name (if available) • BOL number (if available) • Pro number (if available) • Store number, store information, and store barcode



Ship From: Any Vendor Any Address City, State, Zip	Ship To: Walmart DC 6094A - ASM DIS City, State, ZIP code - GLN address Facility Location - 5 digits
CARRIER Carrier Name PRO: 1234567890 B/L: 1234567890	
DC# 6094	TYPE DEPT ORDER# 0033 00012 1234567890
WMIT: 001286123	
(00) 0 0614141 123456789 0	

(Example only)

For questions regarding the electronic submission of ASNs, contact EDI Support at 479-273-8888.

Refer to the Temperature receiving chart in Appendix D for required receiving temperature.

For more information on the Walmart Perishable ZZZZ Compliant ASN, see Walmart Retail Link: Retail Link > Apps > Filter Docs "ED" > EDI-B2B > Guides > Perishable ASN

Produce Shipments

Inbound Pallet Loads for Produce and Reusable Plastic Containers (RPCs)

- Stack RPCs by layer on a 48" x 40" Grade A pallet.
- Ensure all RPCs interlock for a more secure pallet.
- Cross-stack when applicable for greater pallet stability.
- Cases are **required** to withstand clamping equipment.
- Secure pallet using corner boards, plastic bands, and stretch wrap. Product that **requires** unrestricted airflow is **required** to be secured to the pallet with ventilated stretch wrap.
- Gluing, taping, or any other method of fastening the corner boards to the pallet and/or cases is **NOT ALLOWED**.

- Metal bands and clip seals are **NOT ALLOWED**.
- All RPCs on a single pallet are **required** to be the same size. Multiple-sized RPCs on a pallet are **NOT ALLOWED**.
- Straps are **required** to run horizontally and be placed at the base, middle, and top of the pallet.
- Shipments may be refused or rejected if not properly secured on the pallet. Less than layer case quantities are **required** to be secured to the pallet.
- Produce pallets should be trailer loaded in a pinwheel pattern to reduce trailer air space and prevent shifting.
- Single pallet positions should be loaded to one side of the trailer and secured with airbags or load locks.
- Netting and twine for pallet containment are **NOT ALLOWED**.

Fiber Corner Boards

In order to increase recyclability, we strongly encourage the use of corner boards made of 100% plastic or 100% fiber. Mixed material corner boards such as composite or those with a metal or plastic interior and fiber exterior cannot be recycled from our DCs and stores.

- See the Unitized Shipments section of the standards guidelines for corner board requirements.

Suppliers are responsible for ensuring the length, width, and thickness of corner boards are adequate to properly protect and support the product.



CORRECT
Uses corner boards,
plastic bands, and
stretch wrap

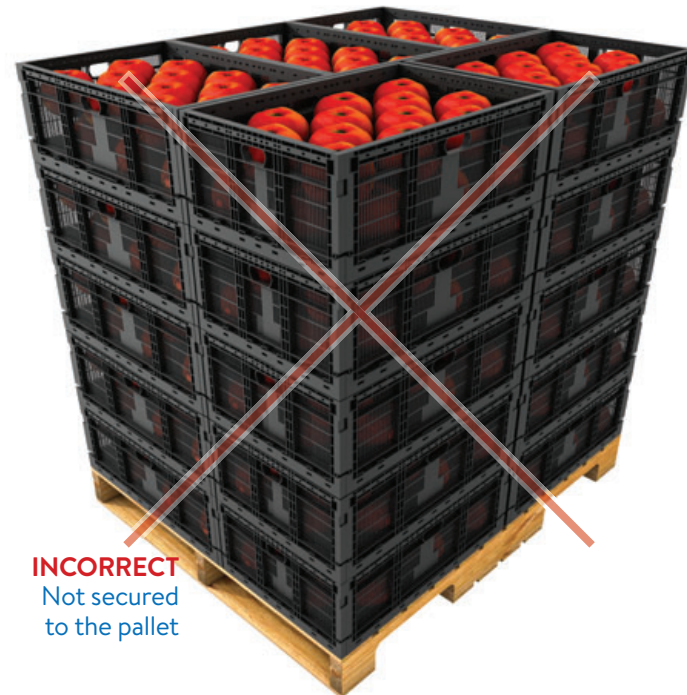

INCORRECT
Not secured
to the pallet

NOTE - Loose film, fiber, or other loose materials are NOT ALLOWED in any open top cartons or containers. All loose material must be removed. All plastic coverings and plastic inner pack bags are NOT ALLOWED to exceed the height of the case.

Bakery/Deli Wraparound Label

Bakery and Deli Wraparound Labels

Bakery and Deli labels (departments 80 and 98 only) contain unique requirements. The examples shown on this page are the preferred wraparound, but 2 single labels that contain the same information are acceptable.

The following information is **required** on each label:

REQUIRED	<ul style="list-style-type: none"> Product Name (36 pt Futura Medium Condensed Font, tracking -20) Best if used by date: (11 pt Futura Medium Condensed Font, tracking -20) Spanish translation of product name (24 pt Futura Medium Condensed Oblique, tracking -20) Connecticut license # (16 pt Futura Medium Condensed, tracking -20 (only required if intended for sale in CT)) 	<ul style="list-style-type: none"> Walmart item number (WMIT) Unit quantity Net weight (Futura Medium Font, 18 pt, 70% Horizontal Scale) Kosher symbol (if applicable) Keep frozen/Keep refrigerated (16 pt Futura Medium Condensed, tracking -20) Selling unit UPC barcode (must include the language "Scan for Cost Inventory" next to the barcode) 14 Digit Supplier Pack (Orderable) GTIN Barcode: (ITF-14 and/or GS1-128 (w/ appropriate application identifier) format, Black ink only)
	<ul style="list-style-type: none"> Case Code Supplier ID # 	<ul style="list-style-type: none"> Supplier stock number Safe handling instructions
OPTIONAL		

Label size is recommended to be 3" x 10" for a single wraparound label or 3" x 5" for 2 single labels. The barcode areas of the label are **required** to be white with black printing. The top area of the label, behind the product name, is **required** to have the following background colors:

- **Frozen or refrigerated non-production items**
White background
- **Frozen production items**
PMS 102 C (yellow) background
- **Refrigerated production items**
PMS 381 C (green) background



Frozen or refrigerated non--production

One-line product name or variety name

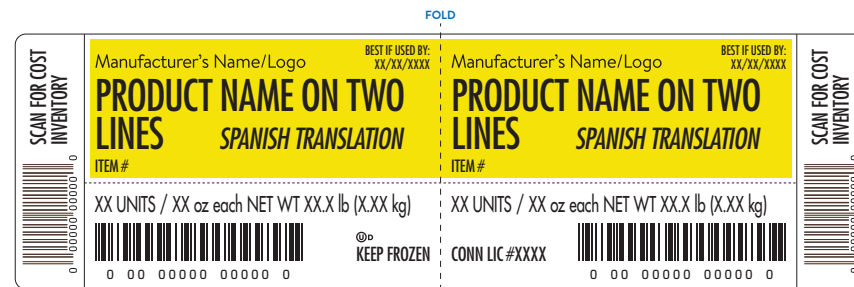

Frozen production

Two-line product name or variety name

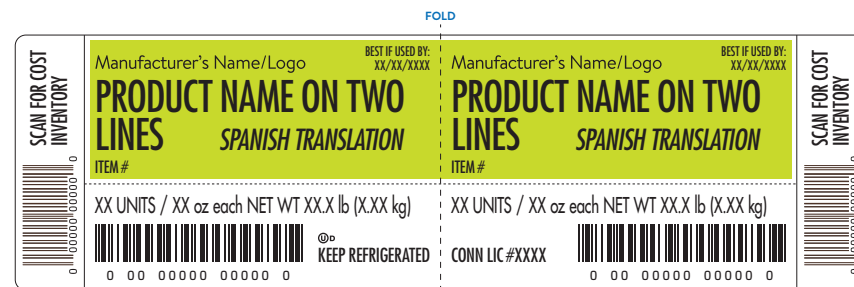

Refrigerated production

Two-line product name or variety name

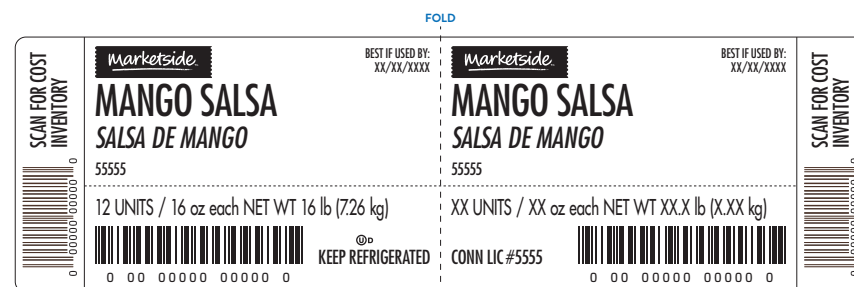

Example only

Perishable Labeling Requirements

Perishable Dates

Perishable products are **required** to be dated with a **receiving date, best if used by date, or pack date**. If the pack date is used as a reference, the Supplier is **required** to provide guidelines to maintain freshness and quality. If the item contains a best if used by date on the retail unit, the outside of the case is **required** to be clearly marked.

Dates are preferred to be in **MM/DD/YYYY** format with a minimum of 1/2" (48 pt) font.

Dated perishable products are received under strict rotation by one of the following dates:

- **Receiving date:** The date product was received, including all frozen products, fresh beef, pork, and poultry.
- **Best if used by date:** The date indicated on product that it must be sold by at retail. This is **required** to be included on the outside of the case if the selling unit contains a best if used by date. This includes produce, deli, and dairy products.
- **Pack date:** The actual date the product was processed.

The original purchase order due date will be used to determine date compliance for receiving acceptance. If the actual receiving is delayed due to Walmart, Sam's Club, or distribution direction, product acceptance will still be governed by the original purchase order due date.



Mixed Dated Pallets

If there is a need for mixed dated product on a pallet, the following steps are **required**.

- Pallets are **required** to be stacked with the oldest date on the top of the pallet.
- Dating on the case is **required** to be turned outward on the pallet.
- A tier sheet is **required** to be placed between each layer where the date changes.
- Pallets are **required** to be clearly marked with an additional 8.5" x 11" label on all four sides of the pallet with the text "**Mixed Dated Pallet.**"
- Labels are **required** to include the number of cases per date contained on the pallet.



Floral Consolidation Centers (FCC)

Floral Consolidation Centers Case Label

The floral case label provides industry standard data to speed the inventory flow of highly perishable products through the supply chain. The information on the floral case label must be both scannable and readable. Use of the floral case label replaces the requirement of general case markings. You are **required** to use the GS1-128 barcode on the floral case label. Use of the floral case label for items other than fresh cut flowers within Dept. 94 is **NOT ALLOWED**.

All fresh cut floral shipments for Dept. 94 are **required** to include the following information:

REQUIRED	<ul style="list-style-type: none"> • Packer Information • Product Description • Net Weight • Country of Origin • Harvest Date 	<ul style="list-style-type: none"> • GS1-128 Barcode: Barcode is required to include Supplier Pack (Orderable) GTIN, Harvest Date, Lot Number, and appropriate application identifiers. • Voice Pick Code • Item Level UPC Barcode
OPTIONAL	<ul style="list-style-type: none"> • Walmart Item # • Handling instructions 	<ul style="list-style-type: none"> • PO # • Additional regulatory information

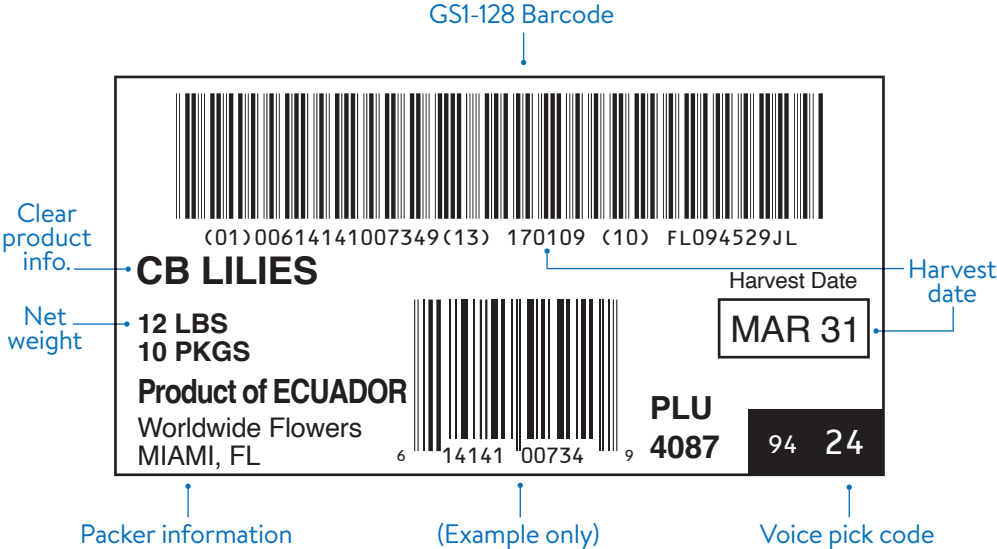

ASN/EDI Requirements for Floral

Floral Suppliers are **required** to submit a Walmart Perishable ZZZZ compliant Advance Ship Notice (ASN) through EDI. The Walmart Perishable ZZZZ ASN provides advanced visibility to incoming shipments and clearly identifies it as produce. For industry information and standards specifications such as label size and formatting, refer to www.gs1us.org and www.producetraceability.org.

- For questions regarding floral labels, contact WMBBarcodeLabeling@walmart.com.
- GS1-128 Barcode is **required** to meet size and print quality standards as referenced in the GS1-128 section of this publication.
- For more information on the Walmart Perishable ZZZZ Compliant ASN, see **Walmart Retail Link:** Retail Link > Apps > Filter Docs “ED” > EDI-B2B > Guides > Perishable ASN

Floral Consolidation Centers (FCC), cont...

Floral Consolidation Cartons

Suppliers are **required** to ship in a standard dry case pack carton. The dry pack carton allows boxes to be palletized correctly and improves the efficiencies of processing fresh cut flowers. Suppliers outside of Miami, FL are **required** to ship to a Floral Consolidation Center.

Standard dry case pack carton size is 38.19" L X 18.90" W X 8.27" H, for a cube of 3.45. If you are not able to meet any of the requirements in this section of the standards, please reach out to the Walmart Inbound Quality Senior Manager at logpkg@wal-mart.com.

Full Pallet floral
stacking orientation
(Example)

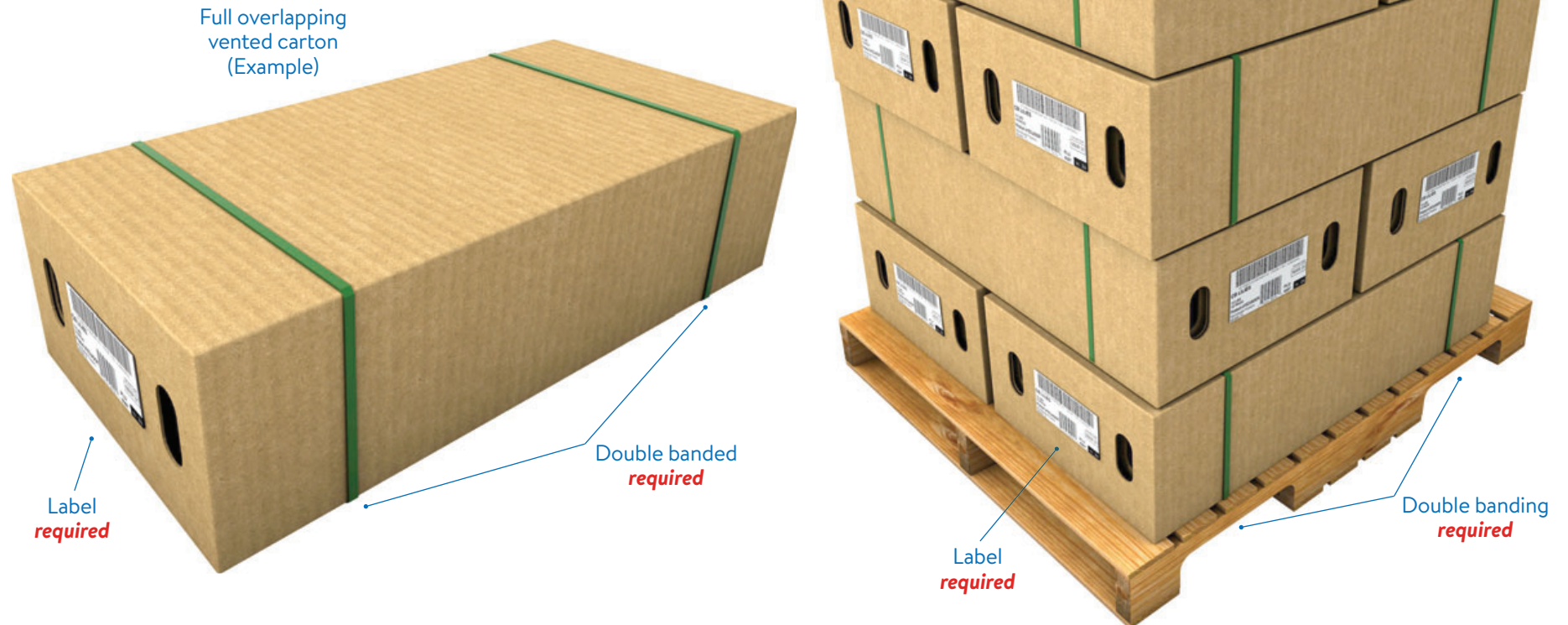

Floral Pallet Label

Floral Pallet Label

The pallet label, along with the SSCC-18 barcode in GS1 format associated with your Walmart Perishable ZZZZ ASN, aids in a faster receiving process and better inventory management. Pallet labels are **required** on two adjacent sides of the pallet. Floral case labels are **required** to be outward facing on a minimum of 1 side when palletized.

REQUIRED	<ul style="list-style-type: none"> • Ship from address: Supplier's address, city, state, zip code. • Ship to address: FCC address, city, state, zip code • Facility/location # (Walmart DC number, e.g., 06094). 	<ul style="list-style-type: none"> • PO number: 10 digits (ORDER #) • Department number (Walmart DEPT number, e.g., 00094) • SSCC-18 barcode in GS1-128 format
OPTIONAL	<ul style="list-style-type: none"> • Sequential numbering of pallets • Expanded GLN address (if available for the ship to address) 	<ul style="list-style-type: none"> • Carrier name (if available) • BOL number (if available) • Pro number (if available) • Store number, store information, and store barcode



Ship From: Any Vendor Any Address City, State, Zip	Ship To: Floral Consolidation Center 1075 S Belt Line Rd Coppell, TX 75019	
CARRIER Carrier Name PRO: 1234567890 B/L: 1234567890		
DC# 6094	TYPE DEPT 0033 00012	ORDER# 1234567890
WMIT: 001286123		
(00) 0 0614141 123456789 0		

- For questions regarding the electronic submission of ASNs, contact EDI Support at 479-273-8888.
- Refer to the Temperature receiving chart in Appendix D for required receiving temperature.
- For more information on the Walmart Perishable ZZZZ Compliant ASN, see Walmart Retail Link: Retail Link > Apps > Filter Docs "ED" > EDI-B2B > Guides > Perishable ASN

(Example only)

Grocery Import Distribution Center (GIDC)

GIDC Requirements

- **For Direct Import Food:** A pallet is **required**.
 - If an acceptable pallet provider is not available at Suppliers origin, slip sheets will be an option with approval.
 - See the Pallet Section of these standards for material requirements.
 - Slip sheets are **required** to have minimum 3" (76.2 mm) wide flaps on a minimum of 2 adjacent sides. At least 1 flap is **required** to face the rear door of the container.
 - See the Slip Sheet Section of these standards for material requirements.
 - Additional Details on GIDC shipping requirements can be found in the Supplier Shipment Onboarding Guide
- Maximum height of a unitized load (palletized or slip sheet) is **NOT ALLOWED** to exceed 56" (1422 mm) with no pallet or 62" (1575 mm) with a pallet.
 - Palletized loads are **NOT ALLOWED** to exceed 2,500 lbs (1,133 kg) in weight, including the pallet
 - Slip Sheet loads are **NOT ALLOWED** to exceed 2,100 lbs (1088 kg) in weight, including the pallet
 - Maximum cargo weight is **NOT ALLOWED** to exceed 17,000 kg for a 20' container or 19,500 kg for a 40' container without approval.
 - Use of Desiccant's and air bags for load stabilization are highly recommended. Refer to the Supplier Shipment Onboarding Guide for additional detail.

NOTE - If a supplier requires an additional copy of the Supplier Shipment Onboarding Guide they can reach out to GSSC@wal-mart.com for more information

NOTE - Suppliers shipping to the GIDC are required to adhere to all general case markings, labeling, and quality standards.

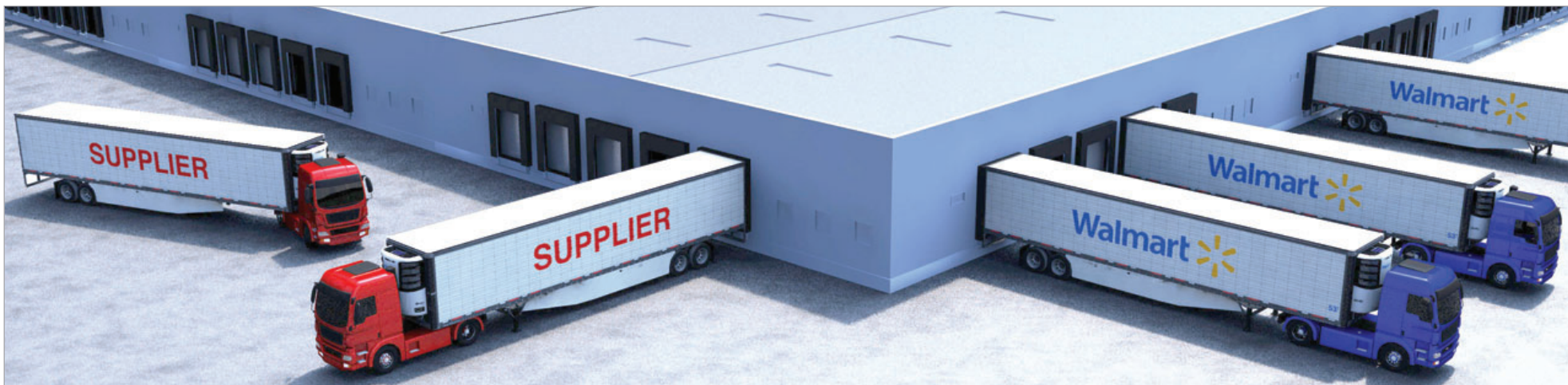

Grocery Import Distribution Center (GIDC)

GIDC Pallet/Slip Sheet Placard Requirements

- Pallets and Slip Sheets shipping to the GIDC are **required** include a Pallet Placard.
- Pallet Placards are **required** on at least 2 adjacent sides of the pallet on the upper right side, preferably in between layers of stretch wrap.
- When placed on a slip sheet, the placards are **required** to be on the same side the slip sheet flaps are located.
- Pallet Placard is **required** to face the door of the container it is loaded on.
- Placard size is **required** to be A4 (8.25" (210mm) X 11.75 (297mm)) with text as large as possible.

NOTE - Please reach out to GSSC@wal-mart.com for pallet/slip sheet placard approval.



REQUIRED	<ul style="list-style-type: none"> • Item Description from PO • Qty of Cases on Pallet • Best By Date 	<ul style="list-style-type: none"> • Walmart Item Number: (WMIT) • Selling Unit (consumable) GTIN Barcode in UPC-A Format • Item UPC Number from PO • Pallet Ti Hi
-----------------	--	--

GV DICED TOMATO	← Item Description From PO
Quantity: 160 Cartons	← Cases On Pallet
Best if used by Date: mm/dd/yyyy	← Best By Date
Item Number: 582832197	← Walmart Item Number
UPC Number: 078742323596	← Item UPC Number From PO
	← Scannable Item UPC Bar Code
Pallet Qty: 16 x 10 = 160 Cases	← Pallet Ti x Hi

Grocery Consolidation Centers (GCC)

GCC Special Requirements

GCC's are a pallet flow said to contain, LTL network. It is imperative to ensure product is properly stacked, secured to a Walmart approved pallet, and properly labeled. Getting this correct on the front end will help with getting the product to the right GDC.

NOTE - Suppliers shipping through GCC network are **required** to adhere to all general case quality, case marking, pallet quality, shipping standards, and cold chain compliance expectations.

Suppliers are **required** to follow all industry/regulation marking standards as well as all Shipping and Routing documentation standards.

Suppliers Shipping to Walmart Grocery Consolidation Center



Consolidation centers play a specialized role in moving products quickly on their journey to the customer. These centers are a passthrough network moving full pallets of perishable product from suppliers, consolidate in a full truckload (FTL) and ship to Walmart grocery distribution centers. Questions? logpkg@wal-mart.com

Routing / Appointment

GCC Shipping & Receiving Schedules - Supplier Delivery Matrix - DC Addresses

[Retail Link](#) > [Academy](#) > [Quick Learning Articles](#) > [Walmart](#) > [Getting Started](#) > [Grocery Supplier Onboarding Standards](#)

PREPAID- CSCL (Confirm shipment created load) 72 hours prior to DNSB

COLLECT – Confirm Shipment by 4:00 P.M. (CST) the day after the order is transmitted, including weekends.

- **Confirm Shipment** can be accessed via the Transportation Supply Chain Portal 2.0 app located under the Apps section on Retail Link.

- **Scheduler 2.0** utilized for appointments

Loading

- Single PO pallets.
- Each pallet is **required** to have a pallet placard and a pallet label.
- Pallets associated with the same PO need to be loaded together.
- Products need to be securely shrink wrapped/banded to the pallet, ensuring product flow through cross-dock.
- Product stabilization and proper securement are **required**.
- Ensure compliant labeling (case and pallet) per Walmart Secondary Packaging Standards.

Shipping

Packaging Requirements

Walmart Secondary Packaging Standards:
[Retail Link](#) > [Supplier Academy](#) > [Item Setup & Management](#) > [Packaging and Labeling](#)

Shipping Requirements Collect

[Retail Link](#) > [Supplier Academy](#) > [Walmart](#) > [Transportation](#) > [Supplier Transportation Onboarding Training](#) > [CS videos location](#)

Prepaid

<https://wal-marttransportation.na1.teamsupport.com/login/user>
[Team Support](#) > [Knowledge Base](#) > [Supplier Documents](#) > [Confirm Shipment Training](#) > [CSCL-Training Document & CS videos location](#).

Focus Points for Successful Delivery and Flow of Product

Consolidation Bill of Lading Requirements (GCC only), Master Bill of Lading Plus Individual Purchase Order/DC Destination

Master BOL	Individual BOL	Intermodal Rail Loads
<ul style="list-style-type: none"> Suppliers are required to provide a master bill of lading to the GCC consolidation center. Consign the master bill to Walmart Stores Inc. The destination address on the master bill is required to be addressed to the Consolidation Dock. <i>Example: GCC 6907</i> Include all purchase order numbers for the total tender. Total number of cases, cube, and weight by purchase order. Place bills in sequential order as loaded. Include the seal number on master BOL. Seal number on BOL is required to match the seal on the trailer or container without any hand-written amendments or alterations. <p>Please see Master BOL section for additional layout/info</p>	<ul style="list-style-type: none"> Suppliers are required to prepare an individual bill of lading for each final destination address. Example: Walmart DC 6042 20634 Indian Meridian Rd Pauls Valley, OK 73075 Include number of cases, pallets/slips, cube, weight, department, and PO type. Bill will need to be created as “Collect.” Put all individual bills of lading for the POs on the load in one envelope and write “Deliver to GCC XXXX” on the front. (XXXX represents the number designation for the consolidation facility, example: GCC 6907.) Attach the master bill of lading to the envelope. <p>Please see Individual BOL section for additional layout/info</p>	<ul style="list-style-type: none"> Product arriving at GCC needs to be compliant with Walmart cold chain compliance. All loads delivering into a GCC are required to a seal intact upon arrival and seal must be notated on the Master BOL. Temperature Guideline: Cooler: 34-37° Freezer: 0 to (-10)° All cooler loads delivering into GCC facilities are required to have 1 temp recorder per trailer. All cooler loads containing seafood/HACCP product are required to have 1 temp recorder per PO. Temp recorders are required to be Emerson GO wireless temperature recorders. For more information/ordering contact: CargoSupport@Emerson.com or call (877) 988-7299

Pallet Quality/Product Securement

- All pallets must meet Walmart Standards.
- Merchandise is **required** to fit within a 48" x 40" pallet footprint. Pallet overhang is **NOT ALLOWED**.
- If pallets do not meet Walmart quality standards, the supplier runs the risk of product damage, loss of product, delivery refusal etc. and the supplier will be held liable for associated charges.
- Product needs to be securely shrink wrapped/banded to pallet ensuring product flow through cross-dock.
- Additional securement including trays, bands, corner boards, etc. may be required depending on product, packaging, height and/or weight and should be applied accordingly.

Pallet Labels/Pallet Placards

- All pallets coming into GCC facilities are **required** to have 2 placards and need to be on adjacent sides of the pallet.
- Placards are **required** as they indicate to the GCC what GDC product needs to ship to.
- All pallets coming into GCC facilities are **required** to have 2 pallet labels and need to be on adjacent sides of the pallet.
- Pallet labels are **required** to be present on all pallets for entry into the destination GDC.
- Pallet labels are **required** to meet the Pallet/Shipping label requirements from the general requirements section of this standard.
- Pallet labels and pallet placards are both **required** and are not interchangeable. Failure to have both present will result in pallet refusal.

Inbound Scheduling

GCC Special Inbound Scheduling Instruction

Appointment Standards

- Load requirements – Single PO cannot exceed 18 pallet positions and/or 32K pounds (These loads will need to ship direct to GDC).
- Appointments must be created/scheduled following the CSCL and Scheduler 2.0 Auto Scheduling process. Training [Academy](#)-> [Ordering and Replenishment](#)-> [Scheduling DC Appts \(first link called “Inbound DC Scheduling”\).](#)
- Inbound loads can only have (1) load ID.
- Updating PO's -Supplier will need to open a transportation portal ticket <https://walmarttransportation.na1.teamsupport.com>. Scheduler 2.0 will need to be updated to reflect new information.
- Late or missed appointments will need to be rescheduled.

Refused / Rejected

- **Refused Product / Loads** – Occurs when product doesn't follow GCC standards. pallet labeling (including placards), BOLS, stability, etc.
- All POs physically on load, but not systematically attached in CSCL / Scheduler will be refused.
- Fixed error and request a new load number through transportation portal. Make sure to include PO numbers. Reschedule new load for delivery.
- **Rejected** - Cold Chain compliance issues (product temperature), damaged product, etc.
- Supplier will need to work with carrier for action plan. Product cannot be redelivered to GCC.

Claims

- **Claims** - occur for anything with inaccuracies.
- **Disputes** - please file through High Radius.
- If you are not signed up for HighRadius, email: HiRadCS@walmart.com for set up instructions.
- For all other inquires, US and PR suppliers, please visit [Retail Link > Learn Tab > Choose your business partner > GBS-NA](#)

Call Center Contact Info:
Phone: (888) 499-6377
Email: wmgbs@wal-mart.com.

Notification Requirements from Suppliers

GCC Notifications for Volume, Product, or Shipping Changes

If Supplier expects to experience any volume, product, or shipping changes with any merchandise which is transported through GCC, Supplier is **required** to notify g0cc@wal-mart.com 30 days in advance of the change or upon Supplier's first awareness of the change, whichever is greater.

Supplier is **required** to notify <https://wal-marttransportation.na1.teamsupport.com> if any of the following are expected:

- New item(s): Supplier adds new product(s) which will be ordered under any of your company's 9-digit Supplier numbers. Supplier is **required** to be approved through Walmart Strategy team.
- Canceled POs cannot be scheduled and will be **refused**. Supplier must ensure all POs are active.
- Additional department(s) or sequence(s): Supplier would like to add additional merchandise departments OR sequences to GCC.
- Discontinued department(s) or sequence(s): Supplier wishes to discontinue utilizing GCC cross dock for one or more merchandise departments or sequences which have been converted to flow through GCC.
- Added warehouse(s): Supplier expands GCC merchandise into additional Walmart SAM's warehouses.
- Discontinued warehouse(s): Supplier discontinues shipping GCC product to any Walmart/SAM's warehouse(s).
- Product mix/pack size/cases per pallet change: Any GCC product changes, pack size, or number of shipping cases per pallet changes that will significantly alter the recent history of average weight per pallet. This includes fluctuations resulting from the above addition or deletion of items as seasons change. Any product change that could affect the way your palletized products will weigh out (or not weigh out) a full load.
- PO revisions: Any PO revisions that take place after the initial order or the entry of RFR must have a load form submitted to Walmart traffic at <https://wal-marttransportation.na1.teamsupport.com>. The costing that will go across your POs is based on the cube on that specific PO. It is critical that you submit any order revisions for pallet/case/cube/weight changes. This must be completed prior to shipping.

Grocery Consolidation Center Pallet Placards

Standard Placard

- Each pallet is **required** to include the approved Walmart Grocery pallet placard with white background (as shown below). Placards are **required** to be placed on adjacent sides of each pallet.
- GCC number
- GDC number
- PO number
- Number of pallets
- Supplier Name

WALMART GROCERY INBOUND
WALMART / SAM'S WAREHOUSE #
6064
CLEBURNE, TX
PO # 0467023122
1 of 4 PALLETS
Supplier Name: ABC Company

GCC pallet placard (example only)

Standard Placard

- Cooler Seafood shipments are **required** to include Walmart Grocery pallet placard for HACCP items with green background (as shown below). Placards are **required** to be placed on adjacent sides of each pallet. This placard is to be used in place of the standard placard for HACCP shipments only.
- GDC number
- PO number
- Number of pallets
- Supplier Name

HACCP ITEMS
6042
PAULS VALLEY, OK
PO# 1234567890
1 OF 2 PALLETS
Supplier Name: ABC Company

GCC Seafood only pallet placard (example only)

Pallet Templates Location - [Retail Link](#) > [Academy](#) > [Quick Learning Articles](#) > [Walmart](#) > [Getting Started](#) > [Grocery Supplier Onboarding Standards](#)

Same PO Multiple Items

Why use single pallet?

- Improved Cube Utilization
- Improved Accuracy
- Reduction in Handling

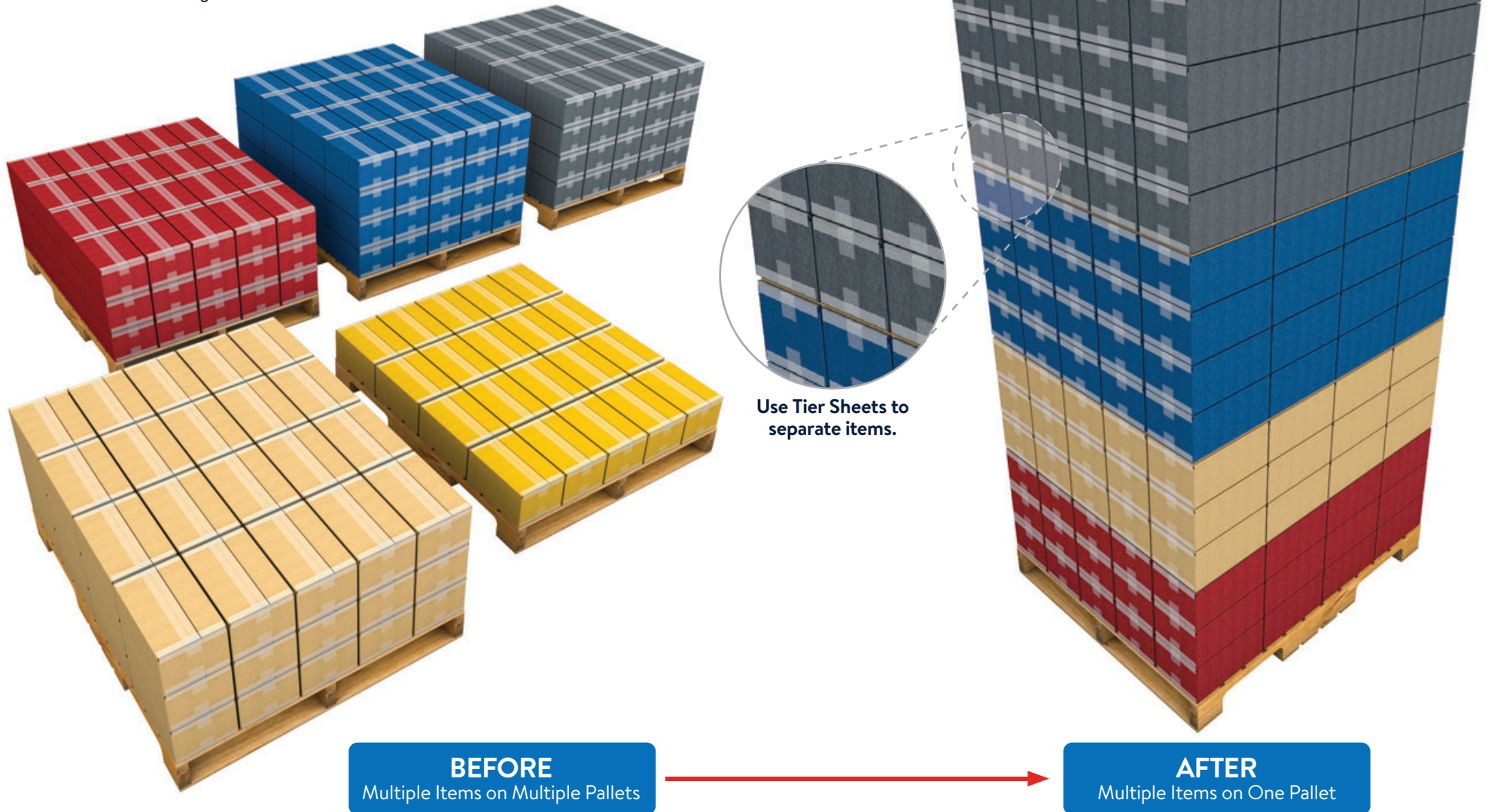



Secondary Packaging

General Merchandise

August 10, 2023

Store Case Labels and Markings

General Merchandise

New Modular Labels (Excluding D56)

For New Modular Sets Only

When shipping in products for new modular sets, you are **required** to use the “new modular” labels shown below on warehouse pack cases and poly bags. Replenishment orders and new store deliveries do not use neon hot pink labels.

Each case **requires** 1 “new modular” label. This label should be applied on the lower corner of the warehouse pack cases and centered on the edge of the case, as shown. This label is in addition to the **required** case markings. This label is **NOT ALLOWED** to interfere with or overlap any other printed case markings or case labels.

Label Sizes

- 1. **Size:** 5" x 1.5"
(for corrugated shipper cases)
Required: 1
Order #: WMG-NMS-002

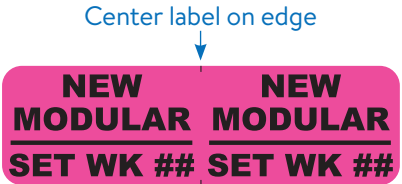

- 2. **Break pack, poly bag size:** 3" x 2"
(for poly bag)
Required: 1
Order #: WMG-NMS-003



NOTE - Place “new modular” labels on warehouse pack cases or poly bags delivered to the stores. DO NOT apply “new modular” labels to primary packaging.

- **Minimum order quantity:** 2,000 labels
- **Color:** Neon Hot Pink

The “new modular” labels can be purchased from either Avery Dennison or Sher Packaging.
Avery Dennison: psd.specialized.sales.support@averydennison.com or
Sher Packaging: WM-ModLabel@sherpackaging.com

NOTE - Place “new modular” labels on the vendor pack case only if there are no internal DC break pack cases. Apply “new modular” labels to the DC break pack cases if DC break pack cases are used.

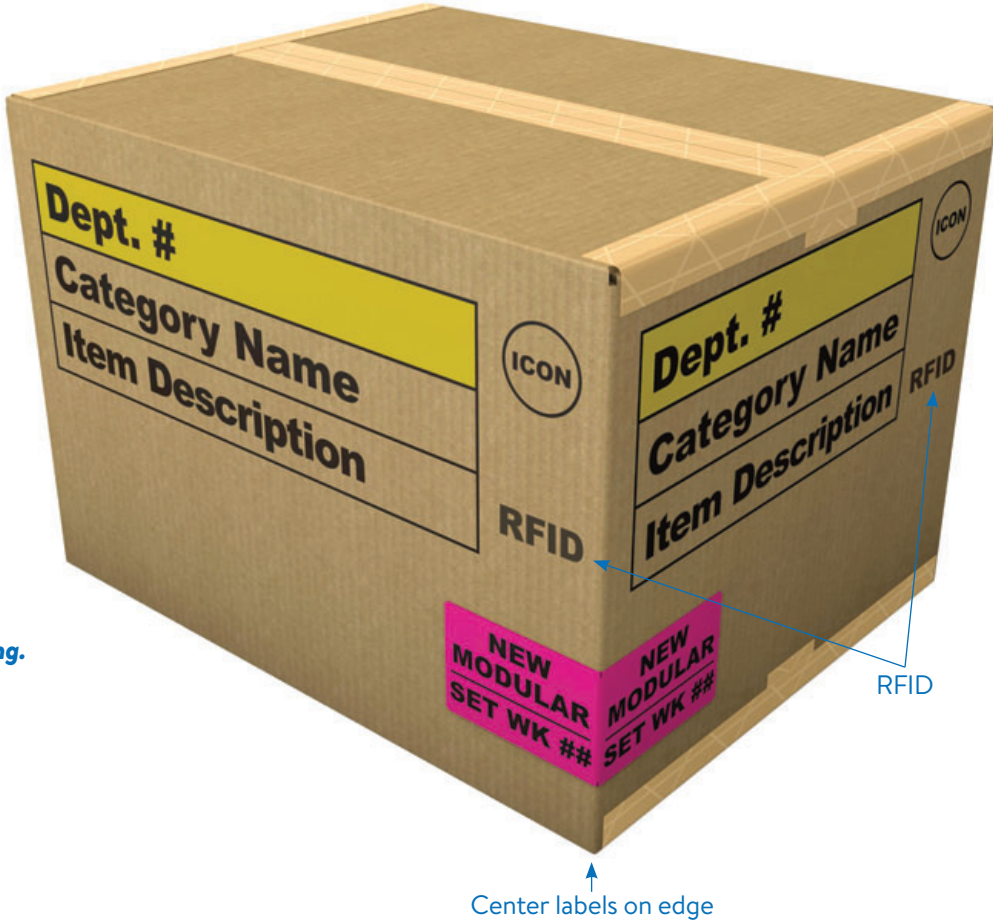

General Merchandise

D56 New Modular Labels (Lawn & Garden)

For D56 New Modular Sets Only

When shipping in products for new modular sets, you are **required** to use the “D56 new modular” labels shown below on warehouse pack cases and poly bags. Replenishment orders and new store deliveries do not use neon green labels.

Each case **requires** 1 “D56 new modular” label. This label should be applied on the lower corner of the warehouse pack cases and centered on the edge of the case, as shown. This label is in addition to the **required** case markings. This label is **NOT ALLOWED** to interfere with or overlap any other printed case markings or case labels.

Label Sizes

1. **Size:** 5" x 1.5"
(for corrugated shipper cases)
Required: 1
Order #: WMLG-CMS-002

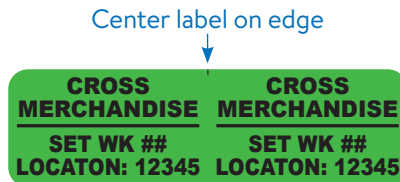

2. **Break pack, poly bag size:** 3" x 2"
(for poly bags)
Required: 1
Order #: WMLG-CMS-003



NOTE - Place “D56 new modular” labels on warehouse pack cases or poly bags delivered to the stores. **DO NOT** apply “D56 new modular” labels to primary packaging.

- **Minimum order quantity:** 2,000 labels
- **Color:** Neon Green

The “D56 new modular” labels can be purchased from either **Avery Dennison** or **Sher Packaging**.
Avery Dennison: psd.specialized.sales.support@averydennison.com
Sher Packaging: WM-ModLabel@sherpacaging.com

NOTE - Place “new modular” labels on the vendor pack case only if there are no internal DC break pack cases. Apply “new modular” labels to the DC break pack cases if DC break pack cases are used.



Store Case Markings

General Merchandise

Case marking formats and icons are in addition to all **required** general case markings. Store case markings are **required** to be applied to all private brand items and national brand items for departments 23 through 34 (apparel); these markings are recommended for all other national brand items.

Store Case Markings for Warehouse Packs

Store case markings are intended to be printed directly on the corrugated warehouse pack cartons; labels can be used at Supplier's discretion. Labels can be used on break pack poly bags.

Vendor pack case artwork

Store case markings are required to be applied to the vendor pack case if there are no DC break pack cartons included.

A Top info bar - **Dept. #** (the background color will vary by department).

B Middle info bar - **Category Name** (category number is optional).

C Bottom info bar - **Item Description**

D Department Icon - Will be the same height as the top info bar and positioned to the right, as shown. For example, if the top info bar is 3", the icon will be 3".

- Text should be as large as possible, vertically centered within each info bar.
- Font: **Arial Black** (Title Case)
- Place the artwork in the upper left corner on all sides of the shipper, 1/2" to 1" from top and left edges. The artwork width will vary from long to short sides and from shipper case to shipper case.
- Cases taller than 12" in height should include a 2" min. or 3" max. per info band.
- Cases less than 12" in height should include a 2" max height info band.
- Info band sizes can be adjusted, as needed, to fit on different size cartons. Contact logpkg@wal-mart.com with proposed layout if you are not sure your layout will meet these requirements.
- Shippers will be printed as 1 color or 2 colors, specified on the following pages.

DC break packs

- DC break packs must meet all required general case marking standards.
- If labels are used for break pack poly bags, they must contain the same information **required** on corrugated shippers.
- Store case markings are **required** to include your department number, category name, and item description. The words "Category Name:" and "Item Description:" must not be printed on the corrugated shipper or labels. Please reach out to your buyer if you are not sure what category name and item description to use.
- Case markings do not apply to retail/SKU specific poly bags within break pack cases. The department icon can be applied to poly bags as a label.

RFID

- Cartons that contain RFID on the selling unit shall add "RFID" under the department icon in bold text.
- Store case are not to be applied to selling units.
- Vertical Bars will have "RFID" marked to the right of the "Item Description" info band aligned with this text.
- Horizontal bars will have "RFID" marked directly below the department icon, at a distance equal to half the height of the uppercase "D" in the Dept# info band.
- "RFID" font will be aligned on both the left and right sides with the department icon.

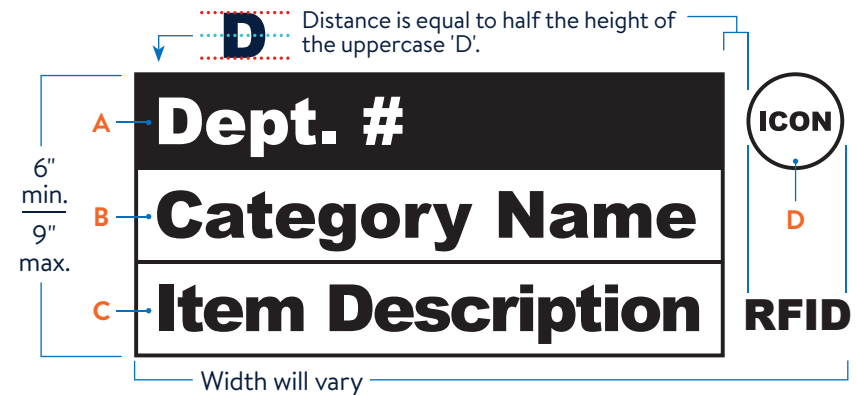

Supplier Pack case



DC break pack

NOTE - For shippers shorter than 7" in height, suppliers may use the horizontal format on all sides.



- 2" info bar (preferred).
- **Dept #** (the background color will vary by department).

Markings Artwork Usage, Examples

Correct Usage

- Each bar will be the same size (width and height).
- The font size should be the same for each line of text.
- The leading between each line should be equidistant from each other.
- The icon should be positioned to the right of the Dept # bar.
Distance equal to half the height of the uppercase 'D' (see previous page).
- The black lines should be a minimum of 6 pt or maximum of 10 pt stroke.



CORRECT

Incorrect Usage



INCORRECT All text bars should be the same height.



INCORRECT Icon is too far away from info box.



INCORRECT Do not horizontally scale box.



INCORRECT The words "Category Name:" and "Item Description:" must not be printed on the corrugated shipper or labels.

General Merchandise

Feature Case Markings

Open this document with Adobe Illustrator to access the vector artwork and icons.

Home, toys, seasonal, and celebrations (D14, 17, 19, 20, 22, 44, 52, 71, and 74)

For all Apparel (D23-D34)

End Cap or Action Alley

Dept. # / WK ##	 RFID
FEATURE	
Category Name	
Item Description	

- Non-modular based items**
- Used for end caps or Action Alley feature items that **ARE NOT active** on a modular.
 - Colors: PMS 285 U and Black

Dept. # / WK ##	 RFID
FEATURE	
Category Name	
Item Description	

- Modular based items**
- Used for end caps or Action Alley feature items that **ARE active** on a modular.
 - Colors: PMS 285 U and Black

Home Pad

Dept. # / WK ##	 RFID
HOME PAD	
Category Name	
Item Description	

- Non-modular based items**
- Used for Home Pad feature items that **ARE NOT active** on a modular.
 - Colors: PMS Yellow 012 U and Black

Dept. # / WK ##	 RFID
HOME PAD	
Category Name	
Item Description	

- Modular based items**
- Used for Home Pad feature items that **ARE active** on a modular.
 - Colors: PMS Yellow 012 U and Black

Apparel

Dept. # / WK ##	 RFID
APPAREL	
Category Name	
Item Description	

- Non-modular based items**
- Used for end caps or Action Alley feature items that **ARE NOT active** on a modular.
 - Colors: PMS 259 U and Black

Dept. # / WK ##	 RFID
APPAREL	
Category Name	
Item Description	

- Modular based items**
- Used for end caps or Action Alley feature items that **ARE active** on a modular.
 - Colors: PMS 259 U and Black

If you have a PDQ display, attach 4 icon labels to the outside of the stretch wrap. Place 1 label near the top, center on each side of the pallet.

NOTE - You DO NOT use the “new modular” labels when one of these case artwork formats is being used on the shipper case.

NOTE - Apply “RFID” to store case markings only if the selling units inside contain RFID Tags.

General Merchandise

Seasonal Department Band Colors

Open this document with Adobe Illustrator to access the vector artwork and icons.

Store Case Markings (Not for Retail Packaging)

Store case marking icons are in addition to all **required** general case markings. These are for example only. Check with your Walmart merchant for specific category name and item description. Layouts can be sent to WMBarcodeLabeling@walmart.com for approval.

 D.14 Summer Housewares Black and 115 U	 D.14 Holiday Housewares Black and 032 U	 D.14/18/20/22 Harvest/ Thanksgiving Black	 D.18/Apparel Halloween Black and 259 U	 D.18/67/Apparel Valentine's Day Black and 032 U	 D.18/67/Apparel Easter Black and 313 U
 D.18/19/44 Harvest (Decor) Black	 D.18/19/44/67 Harvest (Scarecrows) Black	 D.18/67/Apparel St. Patrick's Day Black	 D.32 Gifts Black	 D.46 Holiday Gift Sets Black	 D.52/84 Harvest (Floral) Black
 D.67 Hanukkah Black	 D.67/Apparel Mardi Gras Black	 Apparel Holiday 484 U	 Any Dept Annual Event 675 U	NOTE - BLITZ icon is for non-PDQ display items. (See Annual Event style guide for PDQ display icons.)	

Examples

Check with your merchant or product development for specific category name, item description, and correct seasonal icon.

Dept. 33
Easter
Dresses



Example above is for any Apparel department that has seasonal product. The bar color changes out to the color from each seasonal icon.

Dept. 18 / Cat. # xxxx
Modular Location: x-xxx
Costumes
Item Description



For Halloween costumes ONLY.

General Merchandise

Holiday Time Brand, Band Colors, and Icons

Open this document with Adobe Illustrator to access the vector artwork and icons.

Store Case Markings (Not for Retail Packaging)

Holiday Time is a Walmart private brand. The below icons should only be used for Holiday Time branded items.

Store case marking icons are in addition to all **required** general case markings.

These are for example only. Check with your Walmart merchant for specific category name and item description. Layouts can be sent to WMBarcodeLabeling@walmart.com for approval.

	D.18 Holiday Time (Ornaments) Black		D.18 Holiday Time (Package) 484 U		D.18/Apparel Holiday Time (Front Pad) Black and 200 U		D.18 Holiday Time (Indoor Decor) Black and 7480 U		D.18 Holiday Time (Lights) 7490 U		D.18 Holiday Time (Trees) 3435 U
	D.18 Holiday Time (Outdoor Decor) Black		D.52 Holiday Time (Floral) Black								

Examples

Check with your merchant or product development for specific category name, item description, and correct seasonal icon.

Dept. 18
Category
Item Desc.



Example above is for any department that has seasonal product. The bar color changes out to the color from each seasonal icon.

General Merchandise

Seasonal Department, Band Colors, and Icons

Open this document with Adobe Illustrator to access the vector artwork and icons.

Store Case Markings (Not for Retail Packaging)

Store case marking icons are in addition to all **required** general case markings. These are for example only. Check with your Walmart merchant for specific category name and item description. Layouts can be sent to WMBarcodeLabeling@walmart.com for approval.

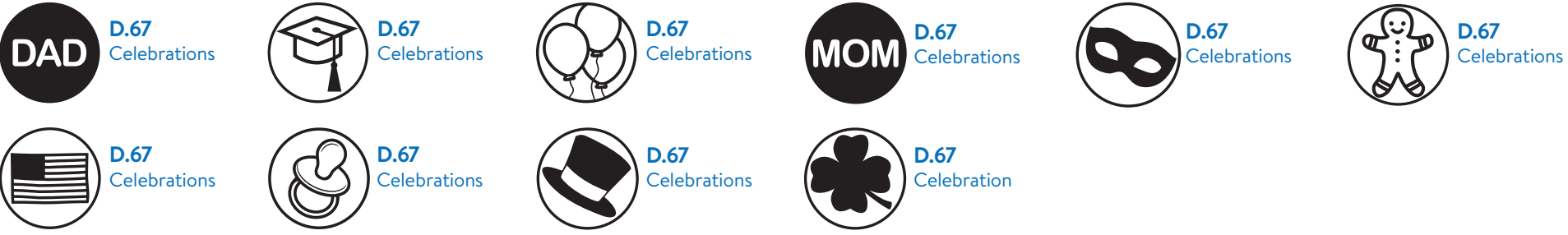

<p>D.67 Celebrations PMS 1505 U and Black</p> <table border="1"> <tr><td>Dept. 67</td></tr> <tr><td>Father's Day</td></tr> <tr><td>Item Description</td></tr> </table> <p></p>	Dept. 67	Father's Day	Item Description	<p>D.67 Celebrations PMS 1505 U and Black</p> <table border="1"> <tr><td>Dept. 67</td></tr> <tr><td>Graduation</td></tr> <tr><td>Item Description</td></tr> </table> <p></p>	Dept. 67	Graduation	Item Description	<p>D.67 Celebrations PMS 1505 U and Black</p> <table border="1"> <tr><td>Dept. 67</td></tr> <tr><td>Balloons</td></tr> <tr><td>Item Description</td></tr> </table> <p></p>	Dept. 67	Balloons	Item Description	<p>D.67 Celebrations PMS 1505 U and Black</p> <table border="1"> <tr><td>Dept. 67</td></tr> <tr><td>Mother's Day</td></tr> <tr><td>Item Description</td></tr> </table> <p></p>	Dept. 67	Mother's Day	Item Description	<p>D.67 Celebrations PMS 1505 U and Black</p> <table border="1"> <tr><td>Dept. 67</td></tr> <tr><td>Mardi Gras</td></tr> <tr><td>Item Description</td></tr> </table> <p></p>	Dept. 67	Mardi Gras	Item Description	<p>D.67 Celebrations PMS 1505 U and Black</p> <table border="1"> <tr><td>Dept. 67</td></tr> <tr><td>Holiday Baking</td></tr> <tr><td>Item Description</td></tr> </table> <p></p>	Dept. 67	Holiday Baking	Item Description
Dept. 67																							
Father's Day																							
Item Description																							
Dept. 67																							
Graduation																							
Item Description																							
Dept. 67																							
Balloons																							
Item Description																							
Dept. 67																							
Mother's Day																							
Item Description																							
Dept. 67																							
Mardi Gras																							
Item Description																							
Dept. 67																							
Holiday Baking																							
Item Description																							
<p>D.67 Celebrations PMS 1505 U and Black</p> <table border="1"> <tr><td>Dept. 67</td></tr> <tr><td>Memorial Day</td></tr> <tr><td>Item Description</td></tr> </table> <p></p>	Dept. 67	Memorial Day	Item Description	<p>D.67 Celebrations PMS 1505 U and Black</p> <table border="1"> <tr><td>Dept. 67</td></tr> <tr><td>Infant</td></tr> <tr><td>Item Description</td></tr> </table> <p></p>	Dept. 67	Infant	Item Description	<p>D.67 Celebrations PMS 1505 U and Black</p> <table border="1"> <tr><td>Dept. 67</td></tr> <tr><td>New Year's Eve</td></tr> <tr><td>Item Description</td></tr> </table> <p></p>	Dept. 67	New Year's Eve	Item Description	<p>D.67 Celebration PMS 1505 U and Black</p> <table border="1"> <tr><td>Dept. 67</td></tr> <tr><td>Celebration</td></tr> <tr><td>Item Description</td></tr> </table> <p></p>	Dept. 67	Celebration	Item Description								
Dept. 67																							
Memorial Day																							
Item Description																							
Dept. 67																							
Infant																							
Item Description																							
Dept. 67																							
New Year's Eve																							
Item Description																							
Dept. 67																							
Celebration																							
Item Description																							

















General Merchandise



















Department Band Colors and Icons

Open this document with Adobe Illustrator to access the vector artwork and icons.

Store Case Markings (Not for Retail Packaging)

Store case marking icons are in addition to all **required** general case markings. These are for example only. Check with your Walmart merchant for specific category name and item description. Layouts can be sent to WMBarcodelabeling@walmart.com for approval.

 D.02 HBA	 D.02 Toothbrushes	 D.02 Travel & Trial Size	 D.03 Card & Party	 D.03 Stationery	 D.04 Paper Goods
 D.05/55/72 Electronics	 D.06/85 Cameras & Supplies	 D.07 Toys	 D.08 Pets	 D.09 Sporting Goods	 D.09 Knives
 D.10/37 Automotive/TLE	 D.11 Hardware	 D.12 Do It Yourself	 D.13 Household Cleaners	 D.14 Cook & Dine	 D.14 Small Appliances

D.02 HBA PMS 1505 U and Black	D.02 Toothbrushes PMS 1505 U and Black	D.02 Travel & Trial Size PMS 1505 U and Black	D.03 Card & Party PMS 1788 U and Black	D.03 Stationery PMS 1788 U and Black	D.04 Paper Goods Black
 Dept. 02 Hair Brushes Item Description	 Dept. 02 Toothbrushes Item Description	 Dept. 02 Shampoo Item Description	 Dept. 03 Card & Party Item Description	 Dept. 03 Stationery Item Description	 Dept. 04 Paper Goods Item Description
D.05/55/72 Electronics Black	D.06/85 Cameras & Supplies Black	D.07 Toys PMS Purple U and Black	D.08 Pets Black	D.09 Sporting Goods PMS 319 U and Black	D.09 Knives PMS 319 U and Black
 Dept. 05 DVD Item Description	 Dept. 06 Cameras Item Description	 Dept. 07 Plush Toys Item Description	 Dept. 08 Pet Toys Item Description	 Dept. 09 Camping Item Description	 Dept. 09 Knives Item Description
D.10/37 Automotive/TLE Black	D.11 Hardware Black	D.12 Do It Yourself Black	D.13 Household Cleaners Black	D.14 Cook & Dine PMS 293 U and Black	D.14 Small Appliances PMS 293 U and Black
 Dept. 10 Oil Item Description	 Dept. 11 Tools Item Description	 Dept. 12 Paint Brushes Item Description	 Dept. 13 Cleaners Item Description	 Dept. 14 Pots Item Description	 Dept. 14 Blenders Item Description

General Merchandise

Department Band Colors and Icons



Open this document with Adobe Illustrator to access the vector artwork and icons.

Store Case Markings (Not for Retail Packaging)

Store case marking icons are in addition to all **required** general case markings.











These are for example only. Check with your Walmart merchant for specific category name and item description. Layouts can be sent to WMBarcodelabeling@walmart.com for approval.

 D.16 Lawn & Garden	 D.17 Home Furnishings	 D.19 Fabric & Crafts	 D.20 Bath & Shower	 D.20 Beach	 D.22 Bedding
 D.23 Mens Underwear	 D.23 Mens Wear	 D.23 Mens Accessories	 D.23 Mens Swimwear	 D.23 Mens Outerwear	 D.23 Mens Socks

Apparel Departments (D23 - D34)

Apparel departments, depending on the category, maybe **required** to have 2 icons. The second icon highlights the merchandising direction. Check with your Walmart Merchant Team contact for questions in merchandising strategy. Icons to the left are used for either the folded pant, folded shirt, or hanger merchandising strategy. Position merchandising icon below department icon.

<p>D.05/55/72 Electronics Black</p> <table border="1"> <tr><td>Dept. 05</td></tr> <tr><td>DVD</td></tr> <tr><td>Item Description</td></tr> </table> 	Dept. 05	DVD	Item Description	<p>D.17 Home Furnishings PMS 1788 U and Black</p> <table border="1"> <tr><td>Dept. 17</td></tr> <tr><td>Home Furnishings</td></tr> <tr><td>Item Description</td></tr> </table> 	Dept. 17	Home Furnishings	Item Description	<p>D.19 Fabric & Crafts PMS 264 U and Black</p> <table border="1"> <tr><td>Dept. 19</td></tr> <tr><td>Fabric & Crafts</td></tr> <tr><td>Item Description</td></tr> </table> 	Dept. 19	Fabric & Crafts	Item Description	<p>D.20 Bath & Shower PMS Rhodamine Red U and Black</p> <table border="1"> <tr><td>Dept. 20</td></tr> <tr><td>Bath & Shower</td></tr> <tr><td>Item Description</td></tr> </table> 	Dept. 20	Bath & Shower	Item Description	<p>D.20 Beach PMS Rhodamine Red U and Black</p> <table border="1"> <tr><td>Dept. 20</td></tr> <tr><td>Beach</td></tr> <tr><td>Item Description</td></tr> </table> 	Dept. 20	Beach	Item Description	<p>D.22 Bedding PMS Rhodamine Red U and Black</p> <table border="1"> <tr><td>Dept. 22</td></tr> <tr><td>Bedding</td></tr> <tr><td>Item Description</td></tr> </table> 	Dept. 22	Bedding	Item Description
Dept. 05																							
DVD																							
Item Description																							
Dept. 17																							
Home Furnishings																							
Item Description																							
Dept. 19																							
Fabric & Crafts																							
Item Description																							
Dept. 20																							
Bath & Shower																							
Item Description																							
Dept. 20																							
Beach																							
Item Description																							
Dept. 22																							
Bedding																							
Item Description																							
<p>D.23 Mens Underwear PMS 287 U and Black</p> <table border="1"> <tr><td>Dept. 23</td></tr> <tr><td>Mens Underwear</td></tr> <tr><td>Item Description</td></tr> </table> 	Dept. 23	Mens Underwear	Item Description	<p>D.23 Mens Wear PMS 287 U and Black</p> <table border="1"> <tr><td>Dept. 23</td></tr> <tr><td>Mens Wear</td></tr> <tr><td>Item Description</td></tr> </table>  <p><small>Use either folded pant, folded shirt, or hanger icon</small></p>	Dept. 23	Mens Wear	Item Description	<p>D.23 Mens Accessories PMS 287 U and Black</p> <table border="1"> <tr><td>Dept. 23</td></tr> <tr><td>Mens Accessories</td></tr> <tr><td>Item Description</td></tr> </table> 	Dept. 23	Mens Accessories	Item Description	<p>D.23 Mens Swimwear PMS 287 U and Black</p> <table border="1"> <tr><td>Dept. 23</td></tr> <tr><td>Mens Swimwear</td></tr> <tr><td>Item Description</td></tr> </table>  <p><small>Use either folded pant, folded shirt, or hanger icon</small></p>	Dept. 23	Mens Swimwear	Item Description	<p>D.23 Mens Outerwear PMS 287 U and Black</p> <table border="1"> <tr><td>Dept. 23</td></tr> <tr><td>Mens Outerwear</td></tr> <tr><td>Item Description</td></tr> </table>  <p><small>Use either folded pant, folded shirt, or hanger icon</small></p>	Dept. 23	Mens Outerwear	Item Description	<p>D.23 Mens Socks PMS 287 U and Black</p> <table border="1"> <tr><td>Dept. 23</td></tr> <tr><td>Mens Socks</td></tr> <tr><td>Item Description</td></tr> </table>  <p><small>Use either folded pant, folded shirt, or hanger icon</small></p>	Dept. 23	Mens Socks	Item Description
Dept. 23																							
Mens Underwear																							
Item Description																							
Dept. 23																							
Mens Wear																							
Item Description																							
Dept. 23																							
Mens Accessories																							
Item Description																							
Dept. 23																							
Mens Swimwear																							
Item Description																							
Dept. 23																							
Mens Outerwear																							
Item Description																							
Dept. 23																							
Mens Socks																							
Item Description																							

General Merchandise

Department Band Colors and Icons

Open this document with Adobe Illustrator to access the vector artwork and icons.













Store Case Markings (Not for Retail Packaging)

Store case marking icons are in addition to all **required** general case markings. These are for example only. Check with your Walmart merchant for specific category name and item description. Layouts can be sent to WMBarcodelabeling@walmart.com for approval.

 D.24 Boys Underwear	 D.24 Boys Wear	 D.24 Boys Socks	 D.24 Boys Swimwear	 D.24 Boys Outerwear	 D.24 Boys Accessories
 D.25 Shoes <small>Shoe specific icon</small>	 D.26 Newborn/Infant/ Toddler	 D.26 Infant & Toddler Swimwear	 D.26 Infant & Toddler Outerwear	 D.26 Infant Onesie/Bodysuit	 D.29 Socks/Hosiery

Apparel Departments (D23 - D34)

Apparel departments, depending on the category, maybe **required** to have 2 icons. The second icon highlights the merchandising direction. Check with your Walmart Merchant Team contact for questions in merchandising strategy. Icons to the left are used for either the folded pant, folded shirt, or hanger merchandising strategy. Position merchandising icon below department icon.

<p>D.24 Boys Underwear PMS 285 U and Black</p> <table border="1"> <tr><td>Dept. 24</td></tr> <tr><td>Boys Underwear</td></tr> <tr><td>Item Description</td></tr> </table> 	Dept. 24	Boys Underwear	Item Description	<p>D.24 Boys Wear PMS 285 U and Black</p> <table border="1"> <tr><td>Dept. 24</td></tr> <tr><td>Boys Wear</td></tr> <tr><td>Item Description</td></tr> </table>  <p><small>Use either Folded pant, folded shirt, or hanger icon</small></p>	Dept. 24	Boys Wear	Item Description	<p>D.24 Boys Socks PMS 285 U and Black</p> <table border="1"> <tr><td>Dept. 24</td></tr> <tr><td>Boys Socks</td></tr> <tr><td>Item Description</td></tr> </table> 	Dept. 24	Boys Socks	Item Description	<p>D.24 Boys Swimwear PMS 285 U and Black</p> <table border="1"> <tr><td>Dept. 24</td></tr> <tr><td>Boys Swimwear</td></tr> <tr><td>Item Description</td></tr> </table>  <p><small>Use either Folded pant, folded shirt, or hanger icon</small></p>	Dept. 24	Boys Swimwear	Item Description	<p>D.24 Boys Outerwear PMS 285 U and Black</p> <table border="1"> <tr><td>Dept. 24</td></tr> <tr><td>Boys Outerwear</td></tr> <tr><td>Item Description</td></tr> </table>  <p><small>Use either Folded pant, folded shirt, or hanger icon</small></p>	Dept. 24	Boys Outerwear	Item Description	<p>D.24 Boys Accessories PMS 285 U and Black</p> <table border="1"> <tr><td>Dept. 24</td></tr> <tr><td>Boys Accessories</td></tr> <tr><td>Item Description</td></tr> </table> 	Dept. 24	Boys Accessories	Item Description
Dept. 24																							
Boys Underwear																							
Item Description																							
Dept. 24																							
Boys Wear																							
Item Description																							
Dept. 24																							
Boys Socks																							
Item Description																							
Dept. 24																							
Boys Swimwear																							
Item Description																							
Dept. 24																							
Boys Outerwear																							
Item Description																							
Dept. 24																							
Boys Accessories																							
Item Description																							
<p>D.25 Shoes Black</p> <table border="1"> <tr><td>Dept. 25</td></tr> <tr><td>Shoes</td></tr> <tr><td>Item Description</td></tr> </table>  <p><small>Shoe specific icon</small></p>	Dept. 25	Shoes	Item Description	<p>D.26 Newborn/Infant/Toddler PMS 368 U and Black</p> <table border="1"> <tr><td>Dept. 26</td></tr> <tr><td>Newborn/Infant</td></tr> <tr><td>Item Description</td></tr> </table>  <p><small>Use either Folded pant, folded shirt, or hanger icon</small></p>	Dept. 26	Newborn/Infant	Item Description	<p>D.26 Infant & Toddler Swimwear PMS 368 U and Black</p> <table border="1"> <tr><td>Dept. 26</td></tr> <tr><td>Infant Swimwear</td></tr> <tr><td>Item Description</td></tr> </table>  <p><small>Use either Folded pant, folded shirt, or hanger icon</small></p>	Dept. 26	Infant Swimwear	Item Description	<p>D.26 Infant & Toddler Outerwear PMS 368 U and Black</p> <table border="1"> <tr><td>Dept. 26</td></tr> <tr><td>Infant Outerwear</td></tr> <tr><td>Item Description</td></tr> </table>  <p><small>Use either Folded pant, folded shirt, or hanger icon</small></p>	Dept. 26	Infant Outerwear	Item Description	<p>D.26 Infant Onesie/Bodysuit PMS 368 U and Black</p> <table border="1"> <tr><td>Dept. 26</td></tr> <tr><td>Infant Onesie</td></tr> <tr><td>Item Description</td></tr> </table>  <p><small>Use either Folded pant, folded shirt, or hanger icon</small></p>	Dept. 26	Infant Onesie	Item Description	<p>D.27/28 Socks/Hosiery PMS 170 U and Black</p> <table border="1"> <tr><td>Dept. 29</td></tr> <tr><td>Socks/Hosiery</td></tr> <tr><td>Item Description</td></tr> </table> 	Dept. 29	Socks/Hosiery	Item Description
Dept. 25																							
Shoes																							
Item Description																							
Dept. 26																							
Newborn/Infant																							
Item Description																							
Dept. 26																							
Infant Swimwear																							
Item Description																							
Dept. 26																							
Infant Outerwear																							
Item Description																							
Dept. 26																							
Infant Onesie																							
Item Description																							
Dept. 29																							
Socks/Hosiery																							
Item Description																							

General Merchandise

Department Band Colors and Icons

Open this document with Adobe Illustrator to access the vector artwork and icons.

Store Case Markings (Not for Retail Packaging)

Store case marking icons are in addition to all **required** general case markings. These are for example only. Check with your Walmart merchant for specific category name and item description. Layouts can be sent to WMBarcodelabeling@walmart.com for approval.



Apparel Departments (D23 - D34)
 Apparel departments, depending on the category, maybe **required** to have 2 icons. The second icon highlights the merchandising direction. Check with your Walmart Merchant Team contact for questions in merchandising strategy. Icons to the left are used for either the folded pant, folded shirt, or hanger merchandising strategy. Position merchandising icon below department icon.

<p>D.29 Intimates PMS 170 U and Black</p> <table border="1"> <tr><td>Dept. 29</td></tr> <tr><td>Underwear</td></tr> <tr><td>Item Description</td></tr> </table>	Dept. 29	Underwear	Item Description	<p>D.29 Sleepwear/Scrubs PMS 170 U and Black</p> <table border="1"> <tr><td>Dept. 29</td></tr> <tr><td>Sleepwear/Scrubs</td></tr> <tr><td>Item Description</td></tr> </table>	Dept. 29	Sleepwear/Scrubs	Item Description	<p>D.30 Foundations PMS 170 U and Black</p> <table border="1"> <tr><td>Dept. 29</td></tr> <tr><td>Bras</td></tr> <tr><td>Item Description</td></tr> </table>	Dept. 29	Bras	Item Description	<p>D.30 Maternity PMS 170 U and Black</p> <table border="1"> <tr><td>Dept. 29</td></tr> <tr><td>Maternity</td></tr> <tr><td>Item Description</td></tr> </table>	Dept. 29	Maternity	Item Description	<p>D.31 Handbag PMS 170 U and Black</p> <table border="1"> <tr><td>Dept. 31</td></tr> <tr><td>Handbag</td></tr> <tr><td>Item Description</td></tr> </table>	Dept. 31	Handbag	Item Description	<p>D.31 Backpacks PMS 170 U and Black</p> <table border="1"> <tr><td>Dept. 31</td></tr> <tr><td>Backpacks</td></tr> <tr><td>Item Description</td></tr> </table>	Dept. 31	Backpacks	Item Description
Dept. 29																							
Underwear																							
Item Description																							
Dept. 29																							
Sleepwear/Scrubs																							
Item Description																							
Dept. 29																							
Bras																							
Item Description																							
Dept. 29																							
Maternity																							
Item Description																							
Dept. 31																							
Handbag																							
Item Description																							
Dept. 31																							
Backpacks																							
Item Description																							
<p>D.31 Wallet PMS 170 U and Black</p> <table border="1"> <tr><td>Dept. 31</td></tr> <tr><td>Wallet</td></tr> <tr><td>Item Description</td></tr> </table>	Dept. 31	Wallet	Item Description	<p>D.31 Hat PMS 170 U and Black</p> <table border="1"> <tr><td>Dept. 31</td></tr> <tr><td>Hat</td></tr> <tr><td>Item Description</td></tr> </table>	Dept. 31	Hat	Item Description	<p>D.31 Umbrella PMS 170 U and Black</p> <table border="1"> <tr><td>Dept. 31</td></tr> <tr><td>Umbrella</td></tr> <tr><td>Item Description</td></tr> </table>	Dept. 31	Umbrella	Item Description	<p>D.31 Glove PMS 170 U and Black</p> <table border="1"> <tr><td>Dept. 31</td></tr> <tr><td>Glove</td></tr> <tr><td>Item Description</td></tr> </table>	Dept. 31	Glove	Item Description	<p>D.32 Kimono PMS 170 U and Black</p> <table border="1"> <tr><td>Dept. 31</td></tr> <tr><td>Category Name</td></tr> <tr><td>Item Description</td></tr> </table>	Dept. 31	Category Name	Item Description	<p>D.32 Jewelry PMS 170 U and Black</p> <table border="1"> <tr><td>Dept. 32</td></tr> <tr><td>Jewelry</td></tr> <tr><td>Item Description</td></tr> </table>	Dept. 32	Jewelry	Item Description
Dept. 31																							
Wallet																							
Item Description																							
Dept. 31																							
Hat																							
Item Description																							
Dept. 31																							
Umbrella																							
Item Description																							
Dept. 31																							
Glove																							
Item Description																							
Dept. 31																							
Category Name																							
Item Description																							
Dept. 32																							
Jewelry																							
Item Description																							
<p>D.32 Ring PMS 170 U and Black</p> <table border="1"> <tr><td>Dept. 32</td></tr> <tr><td>Ring</td></tr> <tr><td>Item Description</td></tr> </table>	Dept. 32	Ring	Item Description	<p>D.33 Girls Wear PMS Pink U and Black</p> <table border="1"> <tr><td>Dept. 33</td></tr> <tr><td>Girls Wear</td></tr> <tr><td>Item Description</td></tr> </table>	Dept. 33	Girls Wear	Item Description																
Dept. 32																							
Ring																							
Item Description																							
Dept. 33																							
Girls Wear																							
Item Description																							

General Merchandise



Department Band Colors and Icons

Open this document with Adobe Illustrator to access the vector artwork and icons.

Store Case Markings (Not for Retail Packaging)













Store case marking icons are in addition to all **required** general case markings. These are for example only. Check with your Walmart merchant for specific category name and item description. Layouts can be sent to WMBarcodelabeling@walmart.com for approval.

 D.33 Girls Foundations	 D.33 Girls Underwear	 D.33 Girls Socks	 D.33 Girls Swimwear	 D.33 Girls Accessories	 D.33 Girls Outerwear
 D.34 Ladies Wear	 D.34 Junior Wear	 D.34 Plus Sizes	 D.34 Outerwear	 D.34 Swimwear	 D.38/40 Pharmacy

Apparel Departments (D23 - D34)

Apparel departments, depending on the category, may be **required** to have 2 icons. The second icon highlights the merchandising direction. Check with your Walmart Merchant Team contact for questions in merchandising strategy. Icons to the left are used for either the folded pant, folded shirt, or hanger merchandising strategy. Position merchandising icon below department icon.

<p>D.33 Girls Foundations PMS Pink U and Black</p> <table border="1"> <tr><td>Dept. 33</td></tr> <tr><td>Girls Foundations</td></tr> <tr><td>Item Description</td></tr> </table> 	Dept. 33	Girls Foundations	Item Description	<p>D.33 Girls Underwear PMS Pink U and Black</p> <table border="1"> <tr><td>Dept. 33</td></tr> <tr><td>Girls Underwear</td></tr> <tr><td>Item Description</td></tr> </table> 	Dept. 33	Girls Underwear	Item Description	<p>D.33 Girls Socks PMS Pink U and Black</p> <table border="1"> <tr><td>Dept. 33</td></tr> <tr><td>Girls Socks</td></tr> <tr><td>Item Description</td></tr> </table> 	Dept. 33	Girls Socks	Item Description	<p>D.33 Girls Swimwear PMS Pink U and Black</p> <table border="1"> <tr><td>Dept. 33</td></tr> <tr><td>Girls Swimwear</td></tr> <tr><td>Item Description</td></tr> </table>  <p><small>Use either folded pant, folded shirt, or hanger icon</small></p>	Dept. 33	Girls Swimwear	Item Description	<p>D.33 Girls Outerwear PMS Pink U and Black</p> <table border="1"> <tr><td>Dept. 33</td></tr> <tr><td>Girls Outerwear</td></tr> <tr><td>Item Description</td></tr> </table>  <p><small>Use either folded pant, folded shirt, or hanger icon</small></p>	Dept. 33	Girls Outerwear	Item Description	<p>D.33 Girls Accessories PMS Pink U and Black</p> <table border="1"> <tr><td>Dept. 33</td></tr> <tr><td>Girls Accessories</td></tr> <tr><td>Item Description</td></tr> </table> 	Dept. 33	Girls Accessories	Item Description
Dept. 33																							
Girls Foundations																							
Item Description																							
Dept. 33																							
Girls Underwear																							
Item Description																							
Dept. 33																							
Girls Socks																							
Item Description																							
Dept. 33																							
Girls Swimwear																							
Item Description																							
Dept. 33																							
Girls Outerwear																							
Item Description																							
Dept. 33																							
Girls Accessories																							
Item Description																							
<p>D.34 Ladies Wear PMS 2593 U and Black</p> <table border="1"> <tr><td>Dept. 34</td></tr> <tr><td>Ladies Wear</td></tr> <tr><td>Item Description</td></tr> </table>  <p><small>Use either folded pant, folded shirt, or hanger icon</small></p>	Dept. 34	Ladies Wear	Item Description	<p>D.34 Juniors Wear PMS 2593 U and Black</p> <table border="1"> <tr><td>Dept. 34</td></tr> <tr><td>Juniors Wear</td></tr> <tr><td>Item Description</td></tr> </table>  <p><small>Use either folded pant, folded shirt, or hanger icon</small></p>	Dept. 34	Juniors Wear	Item Description	<p>D.34 Plus Sizes PMS 2593 U and Black</p> <table border="1"> <tr><td>Dept. 34</td></tr> <tr><td>Plus Sizes</td></tr> <tr><td>Item Description</td></tr> </table>  <p><small>Use either folded pant, folded shirt, or hanger icon</small></p>	Dept. 34	Plus Sizes	Item Description	<p>D.34 Outerwear PMS 2593 U and Black</p> <table border="1"> <tr><td>Dept. 34</td></tr> <tr><td>Outerwear</td></tr> <tr><td>Item Description</td></tr> </table>  <p><small>Use either folded pant, folded shirt, or hanger icon</small></p>	Dept. 34	Outerwear	Item Description	<p>D.34 Swimwear PMS 2593 U and Black</p> <table border="1"> <tr><td>Dept. 34</td></tr> <tr><td>Swimwear</td></tr> <tr><td>Item Description</td></tr> </table>  <p><small>Use either folded pant, folded shirt, or hanger icon</small></p>	Dept. 34	Swimwear	Item Description	<p>D.38/40 Pharmacy Black</p> <table border="1"> <tr><td>Dept. 38</td></tr> <tr><td>Pharmacy</td></tr> <tr><td>Item Description</td></tr> </table> 	Dept. 38	Pharmacy	Item Description
Dept. 34																							
Ladies Wear																							
Item Description																							
Dept. 34																							
Juniors Wear																							
Item Description																							
Dept. 34																							
Plus Sizes																							
Item Description																							
Dept. 34																							
Outerwear																							
Item Description																							
Dept. 34																							
Swimwear																							
Item Description																							
Dept. 38																							
Pharmacy																							
Item Description																							















General Merchandise











































Department Band Colors and Icons

Open this document with Adobe Illustrator to access the vector artwork and icons.

Store Case Markings (Not for Retail Packaging)

Store case marking icons are in addition to all **required** general case markings. These are for example only. Check with your Walmart merchant for specific category name and item description. Layouts can be sent to WMBarcodeLabeling@walmart.com for approval.

 D.41 Team Sports	 D.44 Baking	 D.44 Life Transition	 D.44 Memories	 D.46/59 Cosmetics/ Fragrance	 D.49/50 Optical
 D.52/84 Floral	 D.56 Lawn & Garden	 D.58/87 Connection Center	 D.71 Furniture	 D.74 Luggage	 D.74 Home Management
 D.82 Impulse Buy	 D.79 Infant Consumables				

<p>D.41 Team Sports Black</p> <table border="1"> <tr><td>Dept. 41</td><td></td></tr> <tr><td>Team Sports</td><td></td></tr> <tr><td>Item Description</td><td></td></tr> </table>	Dept. 41		Team Sports		Item Description		<p>D.44 Baking PMS 264 U and Black</p> <table border="1"> <tr><td>Dept. 44</td><td></td></tr> <tr><td>Baking</td><td></td></tr> <tr><td>Item Description</td><td></td></tr> </table>	Dept. 44		Baking		Item Description		<p>D.44 Life Transitions PMS 264 U and Black</p> <table border="1"> <tr><td>Dept. 44</td><td></td></tr> <tr><td>Life Transitions</td><td></td></tr> <tr><td>Item Description</td><td></td></tr> </table>	Dept. 44		Life Transitions		Item Description		<p>D.44 Memories PMS 264 U and Black</p> <table border="1"> <tr><td>Dept. 44</td><td></td></tr> <tr><td>Memories</td><td></td></tr> <tr><td>Item Description</td><td></td></tr> </table>	Dept. 44		Memories		Item Description		<p>D.46/59 Cosmetics/Fragrance Black</p> <table border="1"> <tr><td>Dept. 46</td><td></td></tr> <tr><td>Cosmetics</td><td></td></tr> <tr><td>Item Description</td><td></td></tr> </table>	Dept. 46		Cosmetics		Item Description		<p>D.49/50 Optical Black</p> <table border="1"> <tr><td>Dept. 49</td><td></td></tr> <tr><td>Optical</td><td></td></tr> <tr><td>Item Description</td><td></td></tr> </table>	Dept. 49		Optical		Item Description	
Dept. 41																																									
Team Sports																																									
Item Description																																									
Dept. 44																																									
Baking																																									
Item Description																																									
Dept. 44																																									
Life Transitions																																									
Item Description																																									
Dept. 44																																									
Memories																																									
Item Description																																									
Dept. 46																																									
Cosmetics																																									
Item Description																																									
Dept. 49																																									
Optical																																									
Item Description																																									
<p>D.52/84 Floral Black</p> <table border="1"> <tr><td>Dept. 52</td><td></td></tr> <tr><td>Floral</td><td></td></tr> <tr><td>Item Description</td><td></td></tr> </table>	Dept. 52		Floral		Item Description		<p>D.56 Lawn & Garden PMS 355 U and Black</p> <table border="1"> <tr><td>Dept. 56</td><td></td></tr> <tr><td>Lawn & Garden</td><td></td></tr> <tr><td>Item Description</td><td></td></tr> </table>	Dept. 56		Lawn & Garden		Item Description		<p>D.58/87 Connection Center Black</p> <table border="1"> <tr><td>Dept. 58</td><td></td></tr> <tr><td>Connection Center</td><td></td></tr> <tr><td>Item Description</td><td></td></tr> </table>	Dept. 58		Connection Center		Item Description		<p>D.71 Furniture PMS 362 U and Black</p> <table border="1"> <tr><td>Dept. 71</td><td></td></tr> <tr><td>Furniture</td><td></td></tr> <tr><td>Item Description</td><td></td></tr> </table>	Dept. 71		Furniture		Item Description		<p>D.74 Luggage PMS 362 U and Black</p> <table border="1"> <tr><td>Dept. 74</td><td></td></tr> <tr><td>Luggage</td><td></td></tr> <tr><td>Item Description</td><td></td></tr> </table>	Dept. 74		Luggage		Item Description		<p>D.74 Home Management PMS 362 U and Black</p> <table border="1"> <tr><td>Dept. 74</td><td></td></tr> <tr><td>Home Management</td><td></td></tr> <tr><td>Item Description</td><td></td></tr> </table>	Dept. 74		Home Management		Item Description	
Dept. 52																																									
Floral																																									
Item Description																																									
Dept. 56																																									
Lawn & Garden																																									
Item Description																																									
Dept. 58																																									
Connection Center																																									
Item Description																																									
Dept. 71																																									
Furniture																																									
Item Description																																									
Dept. 74																																									
Luggage																																									
Item Description																																									
Dept. 74																																									
Home Management																																									
Item Description																																									
<p>D.82 Impulse Buy Black</p> <table border="1"> <tr><td>Dept. 82</td><td></td></tr> <tr><td>Impulse Buy</td><td></td></tr> <tr><td>Item Description</td><td></td></tr> </table>	Dept. 82		Impulse Buy		Item Description		<p>D.79 Infant Consumables Black</p> <table border="1"> <tr><td>Dept. 79</td><td></td></tr> <tr><td>Infant Consumables</td><td></td></tr> <tr><td>Item Description</td><td></td></tr> </table>	Dept. 79		Infant Consumables		Item Description																													
Dept. 82																																									
Impulse Buy																																									
Item Description																																									
Dept. 79																																									
Infant Consumables																																									
Item Description																																									

General Merchandise

Back to School, Format and Icon

Open this document with Adobe Illustrator to access the vector artwork and icons.

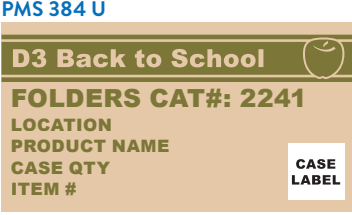
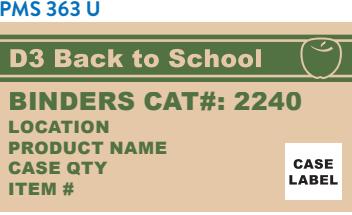
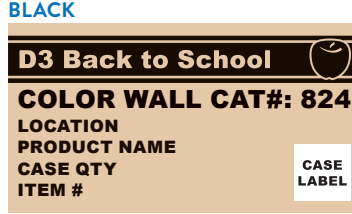
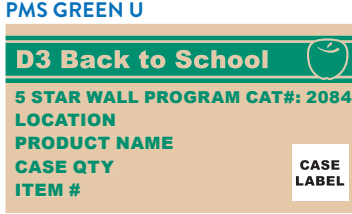
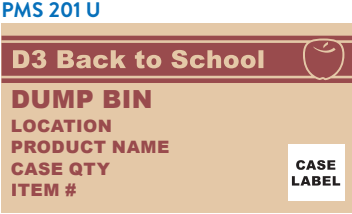
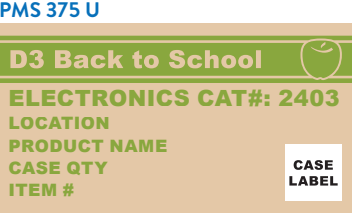
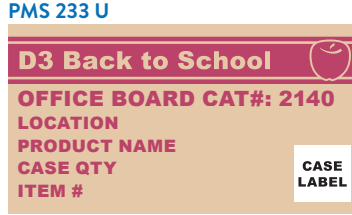
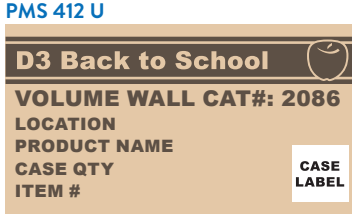
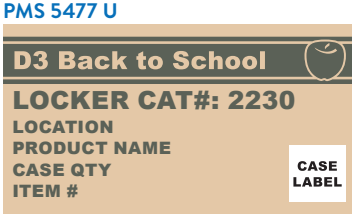
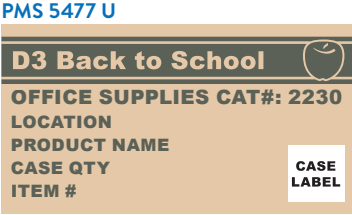
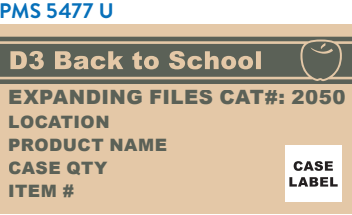
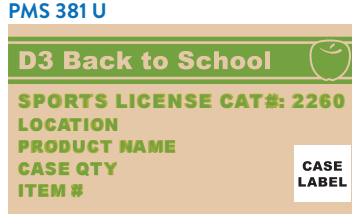
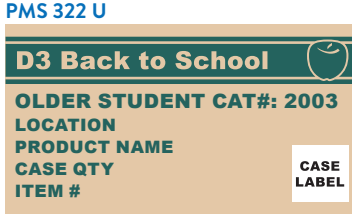
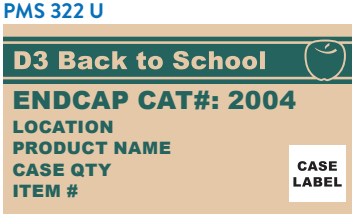
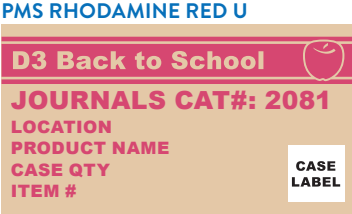
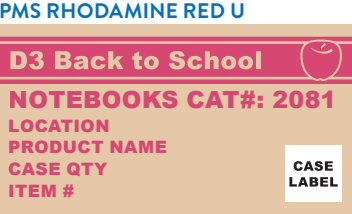
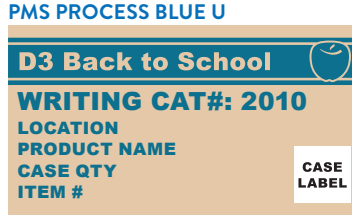
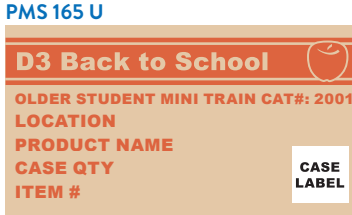
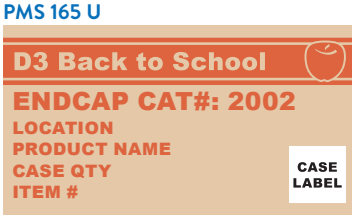
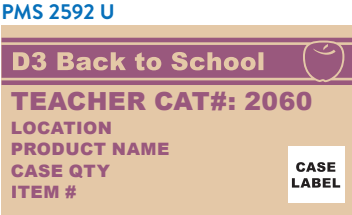
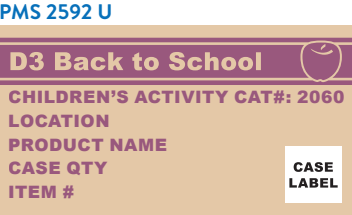

Food

Department Band Colors and Icons - Food

Open this document with Adobe Illustrator to access the vector artwork and icons.

Store Case Markings (Not for Retail Packaging)

Store case marking icons are in addition to all **required** warehouse markings.

These are for example only. Check with your Walmart merchant for specific category name and item description. Layouts can be sent to WMBarcodeLabeling@walmart.com for approval.



D.01
Candy
(everyday)

D.01 Candy
PMS Yellow U and Black

Dept. 01
Hard Candy
Item Description



Food

Deli Case Formatting - Color Band







General Guidelines

These guidelines were developed to standardize deli shipping case markings to enhance organization, storage, and inventory in the deli area.

Color Band

- The color band will be on all 4 sides of the case, as shown.
- The height of the band will be 70% of the case height.
- Position the color band with 10% of the case height on top and 20% on the bottom.
- The Glass Packaging Institute (GPI, formerly GCMI) is the standard color guide to use. Pantone equivalents are provided.
- “**Keep Refrigerated**” only for non-ambient items.

Deli Color-Coded Zones

-  **Cold case** (PMS 1375 U)
-  **Hot case** (PMS 187 U)
-  **Grab-N-Go snacks** (PMS 312 U)
-  **Entertaining** (PMS 253 U)
-  **Meal solutions** (PMS 1817 U)
-  **Deli kits** (PMS 3282 U)

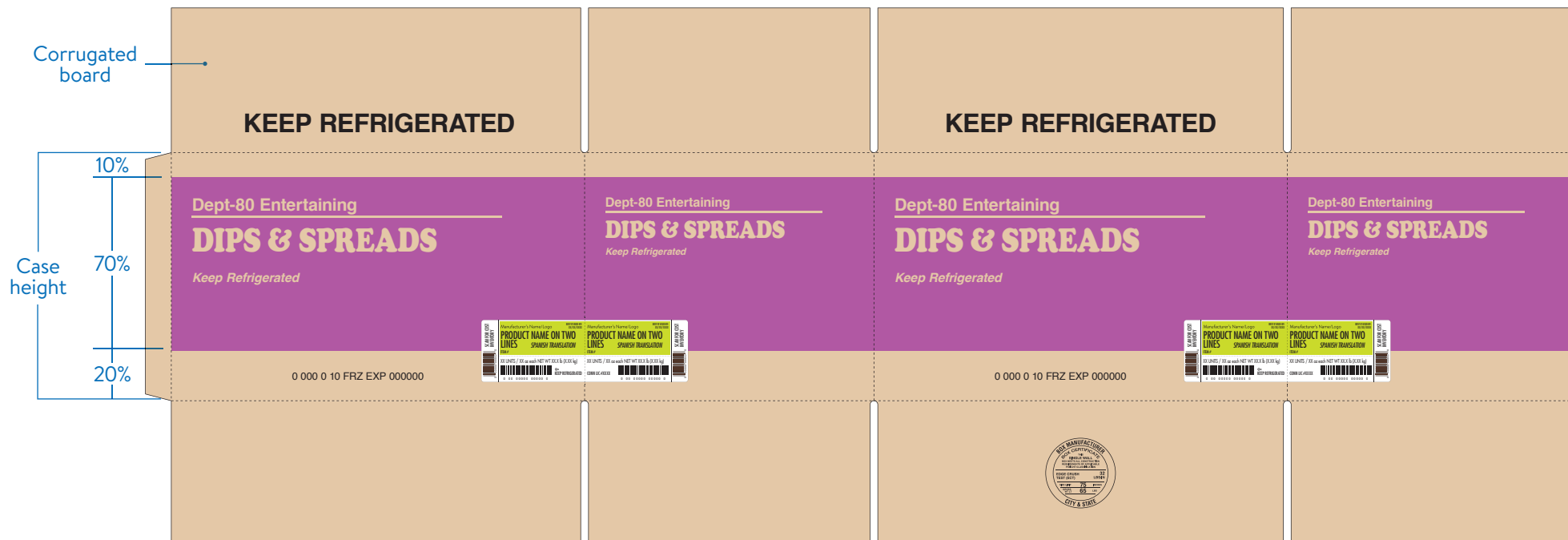

Food

Bakery Case Formatting - Color Band

General Guidelines

These guidelines were developed to standardize bakery shipping case markings to enhance organization, storage, and inventory in the bakery freezer.

Color Band

- The color band will be on all 4 sides of the case, as shown.
- The height of the band will be 70% of the case height.
- Position the color band with 10% of the case height on top and 20% on the bottom.
- The Glass Packaging Institute (GPI, formerly GCM) is the standard color guide to use. Pantone equivalents are provided.
- “Keep Frozen” only for non-ambient items.

Bakery Color-Coded Zones

-  **Bread** (PMS 281 U)
-  **Breakfast** (PMS ORANGE 021 U)
-  **Sweet goods** (PMS 369 U)
-  **Cake ingredients** (PMS 2603 U)

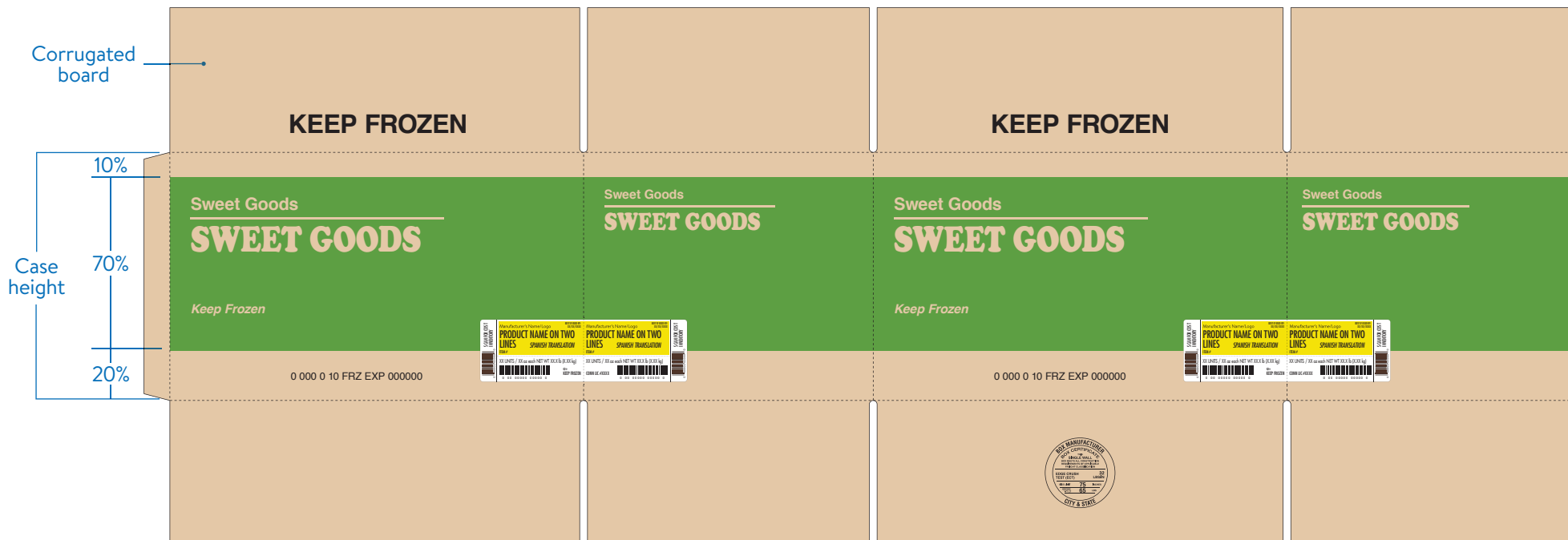

Food

Cake Case/Freezer Door Formatting - Color Band

Guidelines (Applies to Cake Case/Freezer Door Only)

These guidelines were developed to standardize Cake Case/Freezer Door shipping case markings to enhance organization, storage, and inventory in the bakery freezer.

Color Band

- The color band will be on all 4 sides of the case, as shown.
- The height of the band will be 70% of the case height.
- Position the color band with 10% of the case height on top and 20% on the bottom.
- The Glass Packaging Institute (GPI, formerly GCM) is the standard color guide to use. Pantone equivalents are provided.
- “Keep Frozen” only for non-ambient items.

- “**FRAGILE**” must be included on all bakery shipping cases.
 - Place in the upper right section 1/2" from top and right edge of color-coded band (as shown).
 - The minimum preferred size is **6" x 1.5"** proportionately.

FRAGILE

6" x 1.5"

- Place “**UP ARROWS**” 1/2" below FRAGILE and make them as large as possible (as shown).

Color



Cake case/freezer door (PMS 239 U)



Food

Bakery/Deli Case Formatting - Hierarchy

Artwork Lock-up

The lock-up will be located in the upper left corner, approximately 1/2" to 1" from the top and left edge of each panel. All artwork within the color band will be reversed out.

- A. Zone** - For deli only, the zone will begin with "Dept-80"
- Font: Helvetica Bold
- B. Line** - Will be approximately 75% of the width of each panel. The line separates the zone from the category.
- Stroke: 6 pt min./10 pt max.
- C. Category** - Position approximately 2x the space below the line than the space between the zone and the line. There are multiple categories within each zone.
- Font: Cooper Black (80% horizontal scale)
- Font size: Approximately 2x the point size as the zone.
- D. FOR DELI ONLY** - "Keep Refrigerated" or "Keep Frozen" statement will be below the category and printed in black on the top of the case.
- Font: Helvetica Bold or Italic
- Font size: 75% of the zone point size
- Top: Prints in black, size is at Supplier's discretion.
- E. Expiration Date stamp and Best if Used By stamp** - Centered on one of the long sides. You may print UPCs, taglines, or other necessary information in the lower left corner of any other panel.

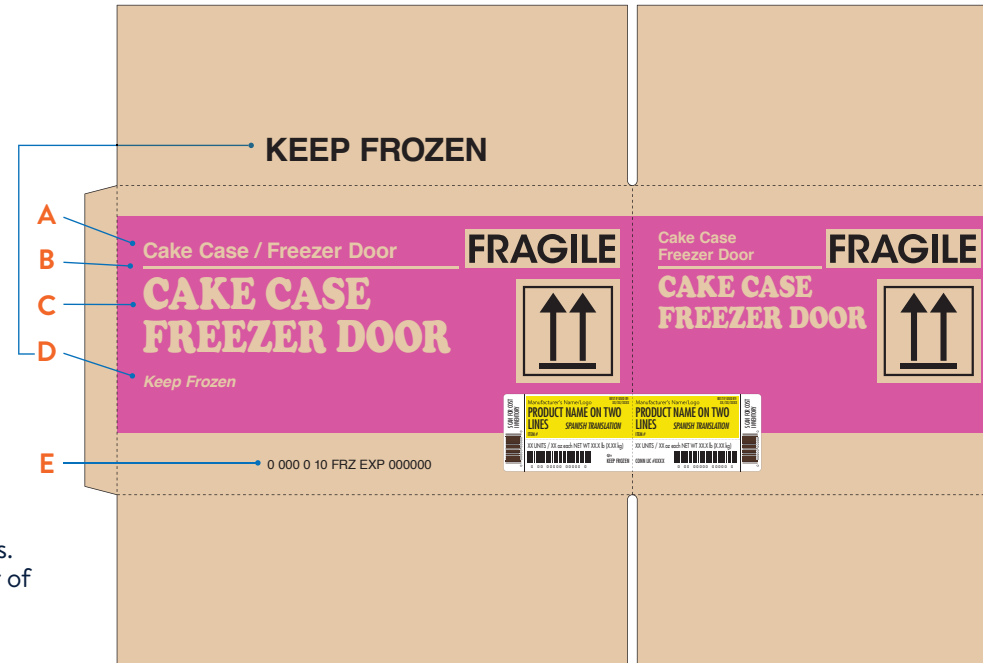

Categories Ask your Walmart merchant if unsure which zone or category your product belongs in.

Deli

Cold Case	Hot Case	Grab-N-Go Snacks	Entertaining	Meal Solutions	Deli Kits
Bulk Meats	Hot Case Meats	Grab-N-Go	Dips & Spreads	Pasta/Sauce	Sandwich Kit (1 of 3, 2 of 3, 3 of 3)
Bulk Cheeses	Hot Case Sides	Pre-Made Sandwiches	Gourmet Cheese	Chilled Meals and Sides	Lettuce Salads
Bulk Salads	Snack Foods	Pre-Made Burritos	Gourmet Meats	Pizza	Cheese Party Tray/Sub
Prepared Meals	Hot Case Seafood	Bottled Drinks	Pre-Made Party Tray	Soups	Meat Party Tray/Sub
Pre-Sliced Meat		Sushi		Wet Salads	Deli Wraps Kit
Pre-Sliced Cheese					Pinwheel Kits

Bakery

Bread	Breakfast	Cake Case / Freezer Door	Sweet Goods	Cake Ingredients
Hearth Breads	Pastries	Pre-Decorated Cakes	Pies	Un-Iced Cake Layers
Sandwich Rolls	Muffins	Cheesecakes	Cakes	Cupcakes
	Donuts	Ice Cream Cakes	Cookies	Whipped Icing
			Brownies	

Food

Bakery/Deli Holiday Icon Labels

Open this document with Adobe Illustrator to access the vector artwork and icons.

Bakery/Deli Holiday Icon Labels (Not for Retail Packaging)

Icon labels are in addition to all **required** general case marking requirements. These are for example only.

Apply 2 labels to lower left of opposing edges as shown below, so that the icon is visible on the long and short sides of the case. The lower right side of the case is reserved for the general case marking label.

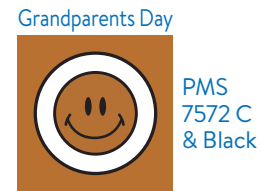
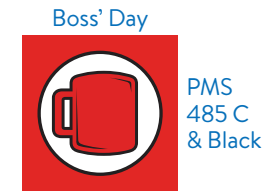
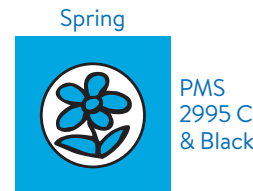
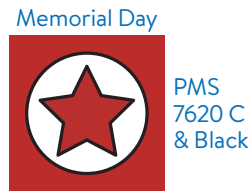
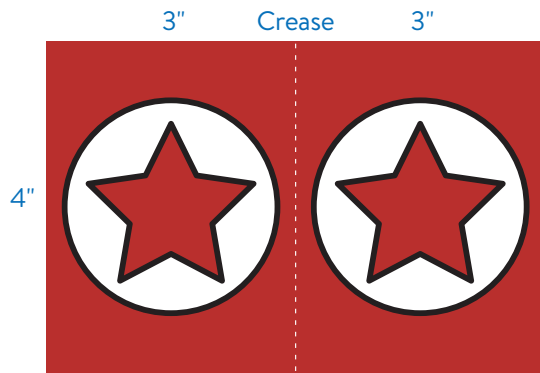

Food

Frozen Seafood Case Formatting - Hierarchy

Artwork Lock-Up

- There are 4 zones in the frozen seafood section:
 - **Raw Shrimp**
 - **Cooked Shrimp**
 - **Frozen Fish**
 - **Assorted Seafood**
- Each case will have a color-coded band that represents its zone. These bands will be printed on all 4 sides of the case. The height of the band should be approximately 70% of the height of the case.
- GCMI is the standard color guide that is used when calling out colors on your artwork. The Pantone equivalents are provided.
- The color-coded band is positioned so that the remaining space is divided with 10% on top and 20% on the bottom.
- A single rule should be the length equal to 75% the length of each side of the case. The rule separates the zone from the various categories within each zone.
- There are multiple categories within each zone. The category name should be listed below the rule (see example).
- The lock-up will be located in the upper left corner. The left margin should be approximately 2x the distance between the zone name and the top of the color-coded band.
- The top right copy indicates the unit size. Type will be the same font and size as the zone.

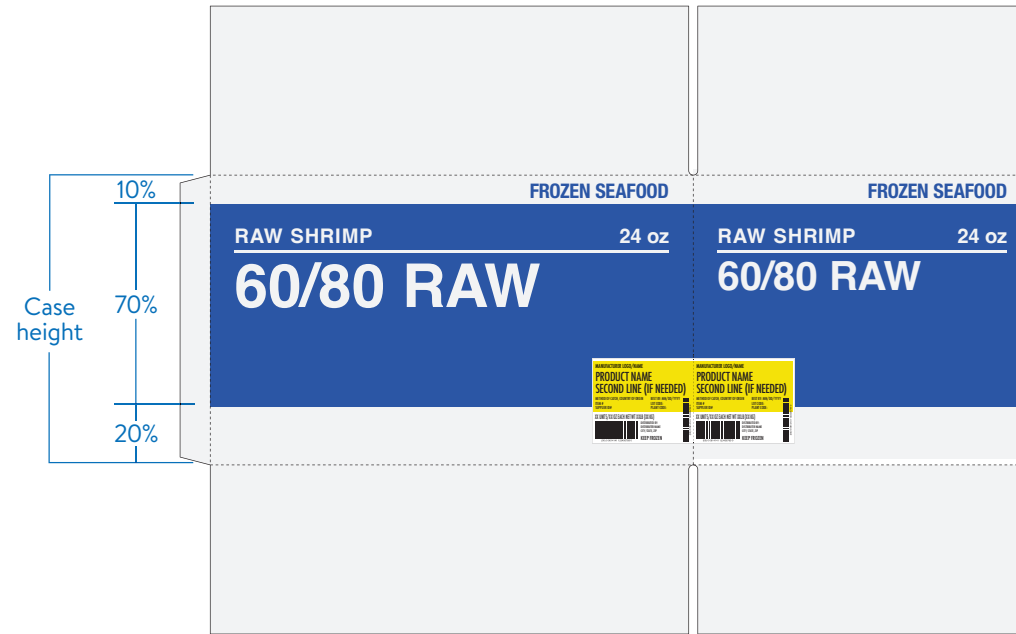

Color band wraps around all 4 sides of case.

Categories

Ask your Walmart merchant if unsure which zone or category your product belongs in.

-  **Raw Shrimp** (GCMI 3229 / PMS 286 U)
-  **Cooked Shrimp** (GCMI 74 / PMS 186 U)
-  **Frozen Fish** (GCMI 25 / PMS 348 U)
-  **Assorted Seafood** (GCMI 49 / PMS 253 U)

Food

Frozen Seafood Case Formatting - Hierarchy

Typography

- All zone names, rules, unit sizes and category names should reverse out of the single-color band. At your discretion, you may print a 2nd color for UPCs, taglines, or any other necessary information in the lower left corner of each or any panel.
- The zone heading and unit size are Helvetica Bold with extra letter spacing for legibility from a distance.
- The category name under the zone and rule should be Helvetica Bold:
 - One line for 12 characters or less
 - Two lines for 12 or more characters
- The category name under the zone and rule should be approximately 2 times the height of the zone name.
- The category name should also have approximately 2-1/2 times the space below the rule than the space between the zone name and the rule.

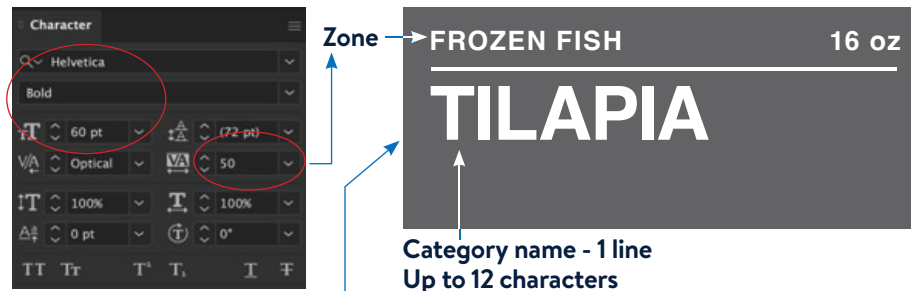

Labels

- All labels for frozen seafood will have a white background, with the exception of thaw and sell items. Thaw and sell items are **required** to be printed with PMS 102 yellow on the top 2.5" of the label.
- Single label or wraparound labels are acceptable. See the Meat/Poultry/Seafood Label section of this guide for additional label requirements.





Secondary Packaging

Appendices

August 10, 2023

Supply Chain

Appendix A: FedEx Labeling and PO Compliance

PO Compliance and Address Standards (for small package FedEx shipments)

In an effort to improve shipment visibility, Walmart started an initiative for Suppliers to transmit accurate PO and store address information to FedEx.

- Upload PO values electronically to FedEx using the standard PO field.
- Use a standard address format for each store using the store file found on Walmart Retail Link.
- Upload shipment data to FedEx at the end of each shipping day for compliance.

Common Address Format

To reduce shipment errors that can result in additional charges and charge-backs, use this format:

- Enter the store name in the Company Name or Company Name equivalent field.
- Make sure you use the correct store name, followed by the appropriate store #:

Walmart # XXX
Supercenter # XXXX
Sam's Club # XXX
Sam's Club DC # XXX
Walmart DC # XXX
Walmart Neighborhood Market # XXX

- The store address goes in address line 1 or the address line 1 equivalent field.

Company Name – Walmart # XXX
Address 1 – 2110 West Walnut
City – Rogers; State – Arkansas; Zip – 72756

- For an updated standard store file, visit Walmart Retail Link. If you use FedEx automation, FedEx can provide you with instructions and the formatted file to import the Walmart stores into your system.

PO Field

- All FedEx small package shipments must display the 10-digit Walmart PO #. Exception: Fixture shipment POs are 6 digits in length.
- PO data must be uploaded to FedEx electronically. If you want to ensure that PO information is uploading correctly to FedEx, you may go to www.fedex.com and follow these steps:

1. Track a shipment that you have shipped to a Walmart location.
2. On the results screen you should see Purchase Order Number. Your PO information should be displayed on this screen.
3. If it is not displayed, your PO information is not uploading correctly.

Uploading Information to FedEx

FedEx provides several different automation platforms that will facilitate sending the Walmart PO on each shipment.

FedEx Automation – All FedEx automation comes with a standard PO field. This field is mapped to upload to FedEx when the day has been closed out. It is crucial for you to end your shipping day and ensure the transmission to FedEx was successful in order to transmit the PO to Walmart.

FedEx.com – The FedEx.com standard PO field is located on the second screen. You can reach the second screen by selecting the **Go to options** button.

FedEx Ship Manager at FedEx.com

Walmart PO #s must be entered correctly on FedEx label.

Under section 4 Billing Details, expand **more reference fields** to enter the Walmart PO #, PO type, and Walmart department number.

To ensure the PO gets electronically transmitted to FedEx, be sure to perform the End of Day Close.

Non-FedEx Automated EPDI/EDI

The PO # must be 10 digits (store fixture POs are 6 digits). PO must be in the detail record. PO # examples would be 1234567890 or 123456.

X12 215 – Use L1101 (PO #) and L1102 (PO qualifier in the 240 Loop).

Proprietary Flat File – You may choose either D132-133 (PO qualifier with D134-163 (10-digit number) or D164-165 (PO qualifier) with D166-195 (10-digit number). If you are not currently using either of these positions in the D record, then you will want to use D132-133 and D134-163. If you're using a third-party system (e.g., Pitney Bowes, Kewill) or transmitting EDI without FedEx hardware, contact your third-party provider for more information on transmitting electronically to FedEx.

EPDI Support Team - 1-800-546-5222 or email epdi@fedex.com.

EDI Support Team - 1-800-546-5222 or email edihelp@fedex.com.

Appendix A: FedEx FAQ

Q. If I already have a FedEx account number, do I need to set up a new account specifically for shipping to Walmart?

A. No. You can use an account in good standing to ship FedEx to Walmart.

Q. How do I ensure my packages make it to the stores damage-free?

A. Make sure you have approved ISTA packaging (www.ista.org). **FedEx provides package testing at no cost to you.** Work with your local FedEx account executive to have your packaging tested. Ensure your shipping labels are PO compliant by using a FedEx automated system to process your packages. Do not place labels on seams or underneath plastic tape or obscure the label in any way.

For proper packaging instructions visit:
<https://images.fedex.com/downloads/shared/packagingtips/howtopack.pdf00>.

Q. Where do I go to get information on PREPAID shipments with FedEx?

A. Call Customer Account Services at **1-800-622-1147** to find out how to ship prepaid packages FedEx Ground or FedEx Express. Also, consult www.fedex.com for detailed information on the many FedEx service options.

Q. Should my item ship collect or third party billing?

A. All items shipping to Walmart or Sams Club Stores or DC's should ship via FedEx Ground Collect. Items shipping for Walmart.com should select third party billing to account # 465070943. If your item is shipping to a specific department or to other location (such as consolidators, store opening solutions, etc.) contact your Walmart Buyer or Walmart GMT Priority for instructions. Walmart GMT priority can be contacted at 479-277-9560 option 5.

Q. Why is it important to close out my shipping system?

A. Closing out your shipping system DAILY ensures that the specific package information, including pickup date and UCC case ID #, is transmitted to FedEx and Walmart in a timely manner. This will also help Suppliers avoid Walmart charge-backs.

Q. Where do I go for the most up-to-date Walmart store list or new locations?

A. For an up-to-date Walmart store list, consult the Walmart vendor site on Walmart Retail Link. You may download the addresses to your automation device. For assistance, contact the Customer Automation Help Desk at **1-800-Go-FedEx (1-800-463-3339)**. Select the correct automation device, and ask for assistance in importing an address list. Be sure to inform them you are a vendor for Walmart.

Q. Who do I contact to ask questions about a FedEx automation device that I already have on the premises?

A. Review the Walmart vendor instructions for shipping collect. For technical support, call **1-877-339-2774** during the following hours: Monday–Friday, 7:00 a.m.–10:00 p.m. CST and Saturday, 7:00 a.m.–7:00 p.m. CST. Be sure to inform them you are a vendor for Walmart.

Q. Who do I contact if I have problems with my FedEx automation device?

A. Call the FedEx hotline that corresponds with your automation device, or contact your local FedEx account executive. For questions regarding Ship Manager at www.fedex.com or QuickShip software, call **1-877-339-2774**. Be sure to inform them you are a vendor for Walmart.

Q. Who do I contact for Walmart Retail Link questions or set up?

A. Call the Walmart Retail Link Help Desk: **479-273-8888**.

Q: Where do I go to ship FedEx Small Parcel billing to 3rd-party for Walmart.com drop ship items?

A: Click Here: [FedEx Quick Guide to Bill 3rd Party](#). Non-compliance to this policy may result in charge-backs to the vendor.

Q. Do I need an SSCC18 barcode when shipping items via FedEx?

A. If your item is shipping to a Walmart Store or DC, an SSCC18 barcode is required. This can be included on your Fed Ex shipping label or may be applied as a separate label.

Appendix B: UPS Labeling and PO Compliance

PO Compliance and Address Standards (for UPS small package shipments)

UPS WorldShip® is a full-featured, Windows-based shipping software application for customers with high volume shipping needs. For all small package shipments, Walmart **requires**:

- All Suppliers shipping UPS small package to Walmart Stores, Sam's Club, and DCs must include the 10-digit Walmart PO # associated with the shipment in the **Reference Number 1** field.
- If it's a fixture PO, the 6 or 7-digit fixture PO # should be used in the **Reference Number 1** field.
- Additional characters such as PO#, PO, P.O. etc. should not be included.
- Each PO must be sent electronically and must appear on each package.
- PO information should be transmitted electronically to UPS at the end of each business day.
- If shipments are being sent consignee billing, Suppliers must be approved consignee billing shippers and should use the approved address listing found on Walmart Retail Link to avoid charge-backs.

Shipment information, including PO #s and shipping addresses may be keyed in manually or imported from a database or delimited text file. If you are not using UPS WorldShip®, contact your software provider for detailed instructions on how to import the PO # into the Reference Number 1 field.

If you have other specific questions regarding using UPS WorldShip® for shipping to Walmart, contact the UPS Walmart support team at **1-800-894-2578** or by email at wm2@ups.com.

Visit www.ups.com for information about additional UPS services.

Instructions for Verifying Correct Walmart PO # Entry

The PO # has been entered correctly if it appears in the REF field on the bottom of the UPS shipping label. Ensure that no letters or symbols appear in this field. Refer to the label example shown.

Address must match exactly as it is listed on Retail Link.

Reference 1 field: The numeric 10-digit PO # should be displayed here.

No letters or symbols should appear in this reference field.

(479) 927-4037
UNITED PARCEL SERVICE
359-A E ROBINSON ST
SPRINGDALE AR 72754-7127

1 LBS 1 OF 1

SHIP TO:
WALMART # 6094
(479) 927-4037
5841 WE REGIONAL AIRPORT BLVD
BENTONVILLE AR 72712

(420) SHIP TO POSTAL CODE

(420) 72712

UPS GROUND
TRACKING #: 1Z 83W 317 03 5103 2117

BILLING: P/P

REF 1: 1234567890

1234567890

UPS
L'envoi est soumis à la validation de l'adresse de destination et à la validation de l'adresse de destination. Les adresses non validées peuvent entraîner des retards de livraison et des frais supplémentaires. Les adresses non validées peuvent également entraîner des frais de retour à l'expéditeur. Les adresses non validées peuvent également entraîner des frais de retour à l'expéditeur. Les adresses non validées peuvent également entraîner des frais de retour à l'expéditeur. Les adresses non validées peuvent également entraîner des frais de retour à l'expéditeur.

NOTE - An SSCC18 barcode is required for all shipments to a Walmart Store or DC. The SSCC18 can be included as part of your UPS Shipping label or may be a separate label.

Appendix C: ISTA Testing

Source: https://ista.org/test_procedures.php#3Series

ISTA 3 Series tests are advanced tests that are designed to challenge the capability of a package and product to withstand transport hazards throughout the supply chain. They are conducted on packaged products where the package and product are considered one unit. These tests are based on the generalized simulation of actual transport hazards and may include random vibrations, shocks, drop tests, and other stresses normally encountered during handling and transportation.

These tests can also be used to evaluate load stability.

Qualifiers

- ISTA 3 Series tests do not necessarily comply with carrier packaging regulations.
- Test levels are based on general data and may not represent any specific distribution system.
- Some conditions of transit, such as moisture, pressure, or unusual handling may not be covered.

When properly executed, the implementation of ISTA testing procedures may provide the following benefits:

- Reduction in damage and product loss.
- Reduction in shipping delays due to damaged freight issues.
- Reduction in claims and claim processing time for damaged freight.
- Improved customer satisfaction which impacts the bottom line.

Overview of Procedure 3A

Packaged Products for Parcel Delivery System Shipments 150 lb. (70 kg) or Less

Test Procedure 3A is a general simulation test for individual packaged products shipped through a parcel delivery system. The test is appropriate for four different packages commonly distributed as individual packages, either by air or ground. These include standard, small, flat, and elongated packages.

Procedure 3A includes an optional test combining random vibration under low pressure which simulates high altitude. This test is designed to test the container's ability to hold a seal or closure and its ability to retain contents without leaking.

Definitions

Standard packaged products. Any packaged product that does not meet any of the definitions below for a small, flat, or elongated packaged product. Standard packaged product may include packages such as traditional fiberboard cases, as well as plastic, wooden, or cylindrical containers.

Small packaged products. Any packaged product which meets the following:

- Volume is less than 800 in³ (13,000 cm³) and
- Longest dimension is 14" (350 mm) or less and
- Weight is 10 lb. (4.5 kg) or less.

Flat packaged products. Any packaged product which meets the following:

- Shortest dimension is 8" (200 mm) or less and
- Next longest dimension is 4 or more times larger than the shortest dimension and
- Volume is 800 in³ (13,000 cm³) or greater.

Elongated packaged products. Any packaged product which meets the following:

- Longest dimension is 36" (900 mm) or greater and
- The other two dimensions of the package are each 20% or less of the longest dimension.

NOTE - If a packaged product is both flat and elongated, the package should be tested as elongated.

Appendix C: ISTA Testing

Overview of Procedure 3B

Packaged Products for Less-Than-Truckload (LTL) Shipments

Procedure 3B is a general simulation test for packaged products shipped through a motor carrier (truck) delivery system, where different types of packaged products, often from different shippers and intended for different ultimate destinations, are mixed in the same load. This type of shipment is called LTL.

Procedure 3B is appropriate for four types of packages commonly included in LTL shipments:

- Standard 200 lb. (91 kg) or less, including elongated and flat packages.
- Standard over 200 lb. (91 kg), including elongated and flat packages.
- Cylindrical, including elongated cylinders.
- Palletized or skidded – Individual container, bulk container, or unitized load on or incorporating a base or platform which allows the entry of lift truck forks.

Testing requirements may include atmospheric conditioning, tip over, shock and impact, random vibration with top load, concentrated impacts, and forklift handling.

Overview of Procedure 3E

Procedure 3E is a general simulation test for unitized loads of similar retail or institutional packaged products shipped from a manufacturing location to a distribution center. The unitized loads of packaged products are shipped through a motor carrier (truck) delivery system, where an entire trailer load is filled with unitized packaged products, often of similar retail packaged products, intended for one destination. This type of shipment is called Full Truckload (FTL).

A unitized load is defined as one or more products or packaged products, usually on a skid or pallet but always secured together or restrained for distribution as a single load. Examples would be a stretch-wrapped pallet load of individual containers, a single non-packaged machine banded to a pallet, or a pallet with a corrugated tray, tube, and a cap.

- It can be used to evaluate the protective performance of packaged products related to vibrations, shocks, and other stresses normally encountered during handling and transportation.
- It can be used to evaluate load stability.
- The test levels are based on general data and may not represent any specific distribution system.
- The package and product are considered together and not separately.
- Some conditions of transit, such as moisture, pressure, or unusual handling, may not be covered.

Other ISTA procedures may be appropriate for different conditions or to meet different objectives.

Overview of Procedure 3F

Test Procedure 3F is a general simulation test for packaged products that are shipped as an individual package from a distribution center to a retail outlet in a mixed pallet configuration.

- It can be used to evaluate the protective performance of packaged products related to vibrations, shocks, and other stresses normally encountered during handling and transportation.
- The test levels are based on general data and may not represent any specific retail distribution system.
- The package and product are considered together and not separately.
- Some conditions of transit, such as moisture, pressure or unusual handling, may not be covered.

Other ISTA procedures may be appropriate for different conditions or to meet different objectives.

■ **NOTE - Refer to: [ista.org/](https://www.ista.org/) for more information.**

Appendix C: ISTA Testing

Source: https://ista.org/test_procedures.php#6Series

ISTA 6 Series test protocols were created by ISTA members to meet their particular purposes and applications. The tests may be completely original or may be modifications or variations of ISTA procedures and projects or other published and accepted tests. ISTA reviews and approves these tests, but primary responsibility rests with the originating members.

Qualifiers

- ISTA 6 Series tests do not necessarily comply with carrier packaging regulations.
- Test levels are based on data specific to the member organization that defined the test protocols and may not represent Walmart-specific distribution systems.
- Some conditions of transit, such as moisture, pressure, or unusual handling may not be covered.

Overview of Procedure 6-SAMSCLUB (Unitized Products for Shipment to Sam's Club)

ISTA® 6-SAMSCLUB was developed by ISTA in cooperation with Sam's Club and is designed as a General Simulation protocol. ISTA 6-SAMSCLUB is a general simulation test for packaged products shipped through the Sam's Club® distribution system to final destinations in the U.S. It was developed from an extensive survey, observation, and field measurement program of the actual Sam's Club system. The program involved personal visits to various Distribution Centers, overseas suppliers and ports, and U.S. Club stores. Ocean containers, trucks, and forklifts were monitored using advanced instrumentation for acceleration and other data. Industry experts translated this information, observation, and data into the Project 6-SAMSCLUB (according to this: <https://keystonecompliance.com/project-6-samsclub/>) laboratory tests.

Overview of Procedure 6-FEDEX-A (Packaged Products for Parcel Delivery System Shipments 150 lb. (70 kg) or Less)

FedEx package testing procedures are based on industry data, as well as international testing procedures and standards, to provide reliable packaging tests for Walmart customers with an active FedEx account number. These are general simulation procedures for testing packaged products weighing up to 150 lbs. We use drop, impact, compression, and vibration tests to evaluate the integrity and protective performance of the packaging.

Definitions

Regular Package

A package that is not defined as flat or elongated.

Flat Package

A package is classified as flat if the shortest dimension is less than or equal to 8", the next shortest dimension is at least four times the length of the shortest dimension, and the volume of the total package is at least 800 cubic inches.

Elongated Package

A package is classified as elongated if the longest dimension is at least 36" and the other two dimensions measure 20 percent or less than the longest dimension.

NOTE - If a packaged product is both flat and elongated, the package should be tested as elongated.

Overview of Procedure 6-FEDEX-B (Packaged Products for Parcel Delivery System Shipments Over 150 lb. (70 kg))

FedEx package testing procedures are based on industry data, as well as international testing procedures and standards, to provide reliable packaging tests for our customers with an active FedEx account number. These are general simulation procedures for testing packaged products weighing more than 150 lbs. We use impact, compression, and vibration tests to evaluate the integrity and protective performance of the packaging.

Because FedEx **requires** that any shipment weighing more than 150 lbs. contain a base that permits movement with a forklift or standard freight pallet jack, the strength of the shipping unit base is also tested for mechanical handling. Finally, the load integrity and stability in the shipping and handling environment are also tested. If at any point during the testing sequences damage is noted, further testing may not be completed.

Appendix D: Walmart & Sam's Club Temperature Standards for Receiving and Storage of Perishable Commodities

Fresh Area	Category	Commodity	Acceptable Receiving Pulp Temp. Range	Required DC & Trailer Storage Temp (All Sam's 34F Produce - Cold preferred)	DC Storage Setpoint And Alarm Ranges	Suggested Trailer Set Points	Top Ice Pack (GDC Only)
Produce	Veg	Aloe vera	33-60	54 DRY	54F - 50/56	54	
Produce	Veg	Anise	33-40	34 WET	34F - 32/36	34	
Produce	Fruit	Apples, all except new season	33-40	34 COLD	34F - 32/36	34	
Produce	Fruit	Apples, new crop (mid Aug - Oct)	33-60	34 COLD	34F - 32/36	34	
Produce	Fruit	Apricots	33-40	34 COLD	34F - 32/36	34	
Produce	Veg	Artichokes: globe, Jerusalem	33-40	34 WET	34F - 32/36	34	
Produce	Veg	Asparagus	33-40	34 WET	34F - 32/36	34	
Produce	Fruit	Avocado, Chilean, mid-late season (CA/MX), new crop, green skin (FL/TX) - WM proposal	34-60	34 COLD	54F - 50/56	54	
Produce	Fruit	Avocado (Sam's Club)	40-60	34 COLD (54F-week 22 to 32)	34F-32/36 (54F wk 22-32)	34 / 54 (wk 22-32)	
Produce	Value	Avomex Guacamole Dip	33-40	34 COLD	34F - 32/36	34	
Produce	Fruit	Banana; leaves, Manzano, red, plantain	40-60	54 DRY	54F - 50/56	54	
Produce	Fruit	Bananas, premium	56-62	Banana rooms		58	
Produce	Veg	Beans, French green (Sam's Club), trimmed green, lima, fava	33-40	34 WET	34F - 32/36	34	
Produce	Veg	Beans, snap or green	33-60	34 WET	34F - 32/36	34	
Produce	Veg	Beets, bunch, root	33-40	34 WET	34F - 32/36	34	yes
Produce	Fruit	Berries, black, blues, cranberries, raspberries, strawberries	33-40	34 COLD	34F - 32/36	34	
Produce	Veg	Bok choy	33-40	34 WET	34F - 32/36	34	
Produce	Veg	Broccoli, broccolini	33-40	34 WET	34F - 32/36	34	yes
Produce	Veg	Brussels sprouts	33-40	34 WET	34F - 32/36	34	yes
Produce	Veg	Cabbage, Chinese (napa), green, red, savoy	33-40	34 WET	34F - 32/36	34	
Produce	Veg	Cactus leaves - bulk	40-60	54 DRY	54F - 50/56	54	
Produce	Veg	Cactus Leaves - packaged	33-60	34 WET	34F - 32/36	34	
Produce	Value	Canela	33-60	54 DRY	54F - 50/56	54	
Produce	Veg	Carrots, topped	33-40	34 WET	34F - 32/36	34	yes
Produce	Veg	Cauliflower	33-40	34 WET	34F - 32/36	34	
Produce	Veg	Celery, hearts, root	33-40	34 WET	34F - 32/36	34	
Produce	Veg	Chard	33-40	34 WET	34F - 32/36	34	yes

Appendix D: Walmart & Sam's Club Temperature Standards for Receiving and Storage of Perishable Commodities

Fresh Area	Category	Commodity	Acceptable Receiving Pulp Temp. Range	Required DC & Trailer Storage Temp (All Sam's 34F Produce - Cold preferred)	DC Storage Setpoint And Alarm Ranges	Suggested Trailer Set Points	Top Ice Pack (GDC Only)
Produce	Veg	Chayotes	33-60	54 DRY	54F - 50/56	54	
Produce	Veg	Cherimoya	40-60	54 DRY	54F - 50/56	54	
Produce	Fruit	Cherries	33-40	34 COLD	34F - 32/36	34	
Produce	Veg	Cilantro bunch	33-40	34 WET	34F - 32/36	34	yes
Produce	Fruit	Coconuts	33-60	34 COLD	34F - 32/36	34	
Produce	Veg	Corn, husk	33-60	54 DRY	54F - 50/56	54	
Produce	Veg	Corn, packaged, sweet	33-40	34 WET	34F - 32/36	34	
Produce	Value	Crepes, fresh	33-40	54 DRY	54F - 50/56	54	
Produce	Veg	Cucumbers, baby, hot house, packaged organic, pickling	33-60	34 WET	34F - 32/36	34	
Produce	Veg	Cucumbers, bulk	45-70	54 DRY	54F - 50/56	54	
Produce	Fruit	Cut fruit	33-40	34 COLD or WET	34F - 32/36	34	
Produce	Veg	Daikon	33-40	34 WET	34F - 32/36	34	
Produce	Fruit	Dates, Medjool	33-40	34 COLD	34F - 32/36	34	
Produce	Fruit	Dragon fruit	40-60	54 DRY	54F - 50/56	54	
Produce	Veg	Eggplant	45-70	54 DRY	54F - 50/56	54	
Produce	Veg	Endive, escarole	33-40	34 WET	34F - 32/36	34	
Produce	Fruit	Feijoas	40-60	54 DRY	54F - 50/56	54	
Produce	Fruit	Figs	33-40	34 COLD	34F - 32/36	34	
Produce	Value	Fresh squeezed juice	33-40	34 COLD	34F - 32/36	34	
Produce	Veg	Garlic, elephant	40-60	54 DRY	54F - 50/56	54	
Produce	Veg	Garlic, peeled	33-40	34 COLD	34F - 32/36	34	
Produce	Veg	Ginger root	33-60	54 DRY	54F - 50/56	54	
Produce	Fruit	Grapefruit bulk (South Africa), CA, AZ, FL TX	40-60	54 DRY	54F - 50/56	54	
Produce	Fruit	Grapes	33-40	34 COLD	34F - 32/36	34	
Produce	Veg	Greens, collards, mustard, turnip	33-40	34 WET	34F - 32/36	34	yes
Produce	Fruit	Guava	40-60	54 DRY	54F - 50/56	54	
Produce	Veg	Herb, arrugula, baby dill, baby leaves, mint, thyme, chives, poultry, sage, rosemary, cilantro	33-60	34 WET	34F - 32/36	34	

Appendix D: Walmart & Sam's Club Temperature Standards for Receiving and Storage of Perishable Commodities

Fresh Area	Category	Commodity	Acceptable Receiving Pulp Temp. Range	Required DC & Trailer Storage Temp (All Sam's 34F Produce - Cold preferred)	DC Storage Setpoint And Alarm Ranges	Suggested Trailer Set Points	Top Ice Pack (GDC Only)
Produce	Veg	Herbs, basil	40-60	54 DRY	54F - 50/56	54	
Produce	Veg	Herbs (lightly dried, paste)	33-40	34 COLD or WET	34F - 32/36	34	
Produce	Veg	Herbs potted (live)	40-60	54 DRY	54F - 50/56	54	
Produce	Veg	Herbs, oregano	33-60	54 DRY	54F - 50/56	54	
Produce	Veg	Horseradish	40-60	54 DRY	54F - 50/56	54	
Produce	Veg	Jicama	40-60	54 DRY	54F - 50/56	54	
Produce	Veg	Kale	33-40	34 WET	34F - 32/36	34	yes
Produce	Fruit	Kiwi fruit (gold, green, green ripe)	33-40	34 COLD	34F - 32/36	34	
Produce	Veg	Kohlrabi	33-40	34 WET	34F - 32/36	34	yes
Produce	Fruit	Kumquat	33-40	34 COLD	34F - 32/36	34	
Produce	Veg	Leeks	33-40	34 WET	34F - 32/36	34	
Produce	Fruit	Lemons	33-60	54 DRY	54F - 50/56	54	
Produce	Fruit	Lemon/Lime Juice	33-40	34 COLD	34F - 32/36	34	
Produce	Veg	Lemongrass	33-40	34 WET	34F - 32/36	34	
Produce	Veg	Lettuce, Boston, green leaf, iceberg, romaine	33-40	34 WET	34F - 32/36	34	
Produce	Fruit	Limes (Mexican, Key) (Persian, Tahiti)	33-60	54 DRY	54F - 50/56	54	
Produce	Fruit	Lychee fruit	33-40	34 COLD	34F - 32/36	34	
Produce	Veg	Malanga root	33-60	54 DRY	54F - 50/56	54	
Produce	Fruit	Mango	48-68	54 DRY	54F - 50/56	54	
Produce	Fruit	Manzanilla	33-60	54 DRY	54F - 50/56	54	
Produce	Fruit	Melons, cantaloupes (local/homegrown), melorange	33-40	34 COLD	34F - 32/36	34	
Produce	Fruit	Melons, Crenshaw, Crenshaw, Gaila, Honeydew, Horned melons, Oranges Flesh, Santa Claus/Piel Del Sapo, Variety	40-60	54 DRY	54F - 50/56	54	
Produce	Fruit	Melons, Golden Kiss, Honey Kiss, Sugar Kiss, Summer Kiss, Mag Melon (Magnificent), Royal	33-60	54 DRY	54F - 50/56	54	
Produce	Fruit	Melons, Juan Canary, Lemon Drop	40-60	54 DRY	54F - 50/56	54	
Produce	Veg	Mushrooms	33-40	34 COLD	34F - 32/36	34	
Produce	Veg	Nopolitos - packaged	33-60	34 WET	34F - 32/36	34	
Produce	Fruit	Nectarines, "Tree Ripe", white-flesh	33-40	34 COLD	34F - 32/36	34	
Produce	Nuts	Nuts, almonds, Brazil, cashew, fiberts, macdamia, pecans, pistachio	40-60	54 DRY	54F - 50/56	54	

Appendix D: Walmart & Sam's Club Temperature Standards for Receiving and Storage of Perishable Commodities

Fresh Area	Category	Commodity	Acceptable Receiving Pulp Temp. Range	Required DC & Trailer Storage Temp (All Sam's 34F Produce - Cold preferred)	DC Storage Setpoint And Alarm Ranges	Suggested Trailer Set Points	Top Ice Pack (GDC Only)
Produce	Nuts	Nuts, chestnuts, water chestnuts	33-40	34 COLD	34F - 32/36	34	
Produce	Nuts	Nuts, walnuts	40-60	54 DRY	54F - 50/56	54	
Produce	Veg	Okra	33-60	34 WET	34F - 32/36	34	
Produce	Veg	Onions, new crop	40-60	54 DRY	54F - 50/56	54	
Produce	Veg	Onions, green	33-40	34 WET	34F - 32/36	34	yes
Produce	Veg	Onions, storage (Bermuda - Granex - Grano - BGG - Other Than)	33-60	54 DRY	54F - 50/56	54	
Produce	Fruit	Oranges (CA, AZ, FL, TX), blood, juice	33-60	34 COLD	34F - 32/36	34	
Produce	Fruit	Papaya, Import & Grocery DCs	48-68	54 DRY	54F - 50/56	54	
Produce	Veg	Parsley, Italian	33-40	34 WET	34F - 32/36	34	yes
Produce	Veg	Parsnips	33-40	34 WET	34F - 32/36	34	
Produce	Fruit	Passion fruit	40-60	54 DRY	54F - 50/56	54	
Produce	Fruit	Peaches, Tree-Ripe, white-flesh	33-40	34 COLD	34F - 32/36	34	
Produce	Nuts	Peanuts, green	33-40	34 WET	34F - 32/36	34	
Produce	Nuts	Peanuts, raw, roasted, salted	40-60	54 DRY	54F - 50/56	54	
Produce	Fruit	Pears (Anjou, Bosc, Bartlett, 20th Century Asian)	33-40	34 COLD	34F - 32/36	34	
Produce	Fruit	Pears (cactus)	45-70	54 DRY	54F - 50/56	54	
Produce	Veg	Peas, sugar snap, snow, black-eyed	33-40	34 WET	34F - 32/36	34	
Produce	Veg	Peppers, anaheim, habanero, Hungarian, mini sweet (variety), poblano, red chili, serrano, yellow chili	33-60	34 WET	34F - 32/36	34	
Produce	Veg	Peppers, bell, green, & colored (packaged & bulk)	40-60	34 WET	34F - 32/36	34	
Produce	Veg	Peppers, jalapeno	40-60	54 DRY	54F - 50/56	54	
Produce	Fruit	Persimmon; Fuyu, Hachiya	33-60	34 COLD	34F - 32/36	34	
Produce	Veg	Piloncillo	33-60	54 DRY	54F - 50/56	54	
Produce	Fruit	Pineapple	45-60	54 DRY	54F - 50/56	54	
Produce	Fruit	Plums, prunes, pluots	33-40	34 COLD	34F - 32/36	34	
Produce	Fruit	Pomegranates	33-40	34 COLD	34F - 32/36	34	
Produce	Veg	Potatoes, new crop, sweet	40-60	54 DRY	54F - 50/56	54	

Appendix D: Walmart & Sam's Club Temperature Standards for Receiving and Storage of Perishable Commodities

Fresh Area	Category	Commodity	Acceptable Receiving Pulp Temp. Range	Required DC & Trailer Storage Temp (All Sam's 34F Produce - Cold preferred)	DC Storage Setpoint And Alarm Ranges	Suggested Trailer Set Points	Top Ice Pack (GDC Only)
Produce	Value	Processed vegetables	33-40	34 WET	34F - 32/36	34	
Produce	Fruit	Pummelo	40-60	54 DRY	54F - 50/56	54	
Produce	Veg	Pumpkins	40-80	54 DRY	54F - 50/56	54	
Produce	Veg	Quinces	33-40	34 COLD	34F - 32/36	34	
Produce	Veg	Radishes	33-40	34 WET	34F - 32/36	34	yes
Produce	Fruit	Rambutan	45-70	54 DRY	54F - 50/56	54	
Produce	Veg	Rhubarb	33-40	34 WET	34F - 32/36	34	
Produce	Veg	Rutabagas	33-40	34 WET	34F - 32/36	34	
Produce	Value	Salad Mix (packaged)	33-40	34 WET	34F - 32/36	34	
Produce	Veg	Shallot	33-60	34 COLD	34F - 32/36	34	
Produce	Veg	Spinach	33-40	34 WET	34F - 32/36	34	
Produce	Veg	Sprouts, alfalfa, bean	33-40	34 WET	34F - 32/36	34	
Produce	Veg	Squash, hard-skin, winter	48-68	54 DRY	54F - 50/56	54	
Produce	Veg	Squash, soft-skin, summer	40-60	34 WET	34F - 32/36	34	
Produce	Fruit	Star fruit	33-60	54 DRY	54F - 50/56	54	
Produce	Veg	Sunchokes	33-40	34 COLD	34F - 32/36	34	
Produce	Veg	Taboli	33-60	54 DRY	54F - 50/56	54	
Produce	Veg	Tamarillo	33-40	34 COLD	34F - 32/36	34	
Produce	Fruit	Tamarindo bean	33-60	34 COLD	34F - 32/36	34	
Produce	Fruit	Tangerines and Mandarin oranges	33-60	34 COLD	34F - 32/36	34	
Produce	Veg	Taro root	33-60	54 DRY	54F - 50/56	54	
Produce	Fruit	Tomatillo	40-60	54 DRY	54F - 50/56	54	
Produce	Fruit	Tomatoes, firm-ripe (stage 5-6), mature-green (Stage 2-4)	45-70	54 DRY	54F - 50/56	54	
Produce	Fruit	Tomatoes, Nature Sweet Cherub, Sunburst, Glory, jubilee, constellation	45-70	54 DRY	54F - 50/56	54	
Produce	Veg	Turnip, roots	33-40	34 WET	34F - 32/36	34	
Produce	Fruit	Uglifruit	33-40	34 COLD	34F - 32/36	34	
Produce	Value	Vegetable florets	33-40	34 WET	34F - 32/36	34	

Appendix D: Walmart & Sam's Club Temperature Standards for Receiving and Storage of Perishable Commodities

Fresh Area	Category	Commodity	Acceptable Receiving Pulp Temp. Range	Required DC & Trailer Storage Temp (All Sam's 34F Produce - Cold preferred)	DC Storage Setpoint And Alarm Ranges	Suggested Trailer Set Points	Top Ice Pack (GDC Only)
Produce	Value	Vegetable sticks (celery/carrots)	33-40	34 WET	34F - 32/36	34	
Produce	Value	Vegetable stir fry blends	33-40	34 WET	34F - 32/36	34	
Produce	Value	Vegetable trays	33-40	34 WET	34F - 32/36	34	
Produce	Veg	Watercress	33-40	34 WET	34F - 32/36	34	yes
Produce	Fruit	Watermelons	50-95	54 DRY	54F - 50/56	54	
Produce	Fruit	Watermelons, Personal	40-80	54 DRY	54F - 50/56	54	
Produce	Veg	Yucca root	33-60	54 DRY	54F - 50/56	54	
Meat	Lamb	Fresh lamb	28-40	29 MT	29.5F - 27/34	30	
Meat	Bison	Fresh bison	28-40	29 MT	29.5F - 27/34	30	
Meat	Meat	Beef (boxed - WM)	28-36	29 MT	29.5F - 27/34	30	
Meat	Meat	Beef (boxed - Sam's Club)	28-40	29 MT	29.5F - 27/34	30	
Meat	Meat	Case ready (beef, pork, ground beef)	28-36	29 MT	29.5F - 27/34	30	
Meat	Meat	Ground meats	28-36	29 MT	29.5F - 27/34	30	
Meat	Meat	Pork - vacuum pack (ribs, roasts, etc)	28-40	29 MT	29.5F - 27/34	30	
Meat	Poultry	Poultry - rotisserie chicken (Walmart & Sam's)	28-36	29 MT	29.5F - 27/34	30	
Meat	Poultry	Poultry (WM - chilled/fresh)	26-34	29 MT	29.5F - 27/34	30	
Meat	Poultry	Poultry (Sam's - chilled/fresh)	28-36	29 MT	29.5F - 27/34	30	
Meat	Seafood	Hermetically sealed finfish prone to histamine - Herring	28-38	29 MT	29.5F - 27/34	30	
Meat	Seafood	Raw crustacean - crab, crawfish, lobster, shrimp	28-40	29 MT	29.5F - 27/34	30	
Meat	Seafood	Raw finfish (histamine) - tuna, mahi-mahi, mackerel	28-38	29 MT	29.5F - 27/34	30	
Meat	Seafood	Raw shucked (pre-packaged or repacked) clams, oysters, mussels, scallops	28-40	29 MT	29.5F - 27/34	30	
Meat	Seafood	Refrigerated - vacuumed packed RTE - fully cooked sushi	28-38	29 MT	29.5F - 27/34	30	
Meat	Seafood	RTE pasteurized crabmeat, seafood salads & soup, surimi based items	28-40	34 DD	34F - 32/36	34	
Meat	Seafood	RTE tuna salad	28-38	34 DD	34F - 32/36	34	
Meat	Seafood	Vacuum Packed Oxygen Permeable Fresh Fish - Tilapia, Salmon, Grouper, Cod, Trout, and ETC. (WM)	28-40	29 MT	29.5F - 27/34	30	
Meat	Seafood	Vacuum Packed Oxygen Permeable Fresh Fish - Tilapia, Salmon, Grouper, Cod, Trout, and ETC. (Sam's Club)	15-40	29 MT	29.5F - 27/34	30	
Meat	Seafood	Vacuum packed smoked salmon (WM)	28-38	29 MT	29.5F - 27/34	30	
Meat	Seafood	Vacuum packed smoked salmon (Sam's Club)	26-40	29 MT	29.5F - 27/34	30	

Appendix D: Walmart & Sam's Club Temperature Standards for Receiving and Storage of Perishable Commodities

Fresh Area	Category	Commodity	Acceptable Receiving Pulp Temp. Range	Required DC & Trailer Storage Temp (All Sam's 34F Produce - Cold preferred)	DC Storage Setpoint And Alarm Ranges	Suggested Trailer Set Points	Top Ice Pack (GDC Only)
Floral	Fresh Cut	Carnations	33-38	34 WET	34F - 32/36	34	
Floral	Fresh Cut	Carnations, mini	33-38	34 WET	34F - 32/36	34	
Floral	Fresh Cut	Chrysanthemums	33-38	34 WET	34F - 32/36	34	
Floral	Fresh Cut	Daisy	33-38	34 WET	34F - 32/36	34	
Floral	Fresh Cut	Daisy, Gerbera	33-38	34 WET	34F - 32/36	34	
Floral	Fresh Cut	Gladioli	33-38	34 WET	34F - 32/36	34	
Floral	Fresh Cut	Iris	33-38	34 WET	34F - 32/36	34	
Floral	Fresh Cut	Lillies	33-38	34 WET	34F - 32/36	34	
Floral	Fresh Cut	Mixed bouquets	33-38	34 WET	34F - 32/36	34	
Floral	Fresh Cut	Orchids (Dept 56)	33-38	54 DRY	54F - 50/56	45	
Floral	Fresh Cut	Orchids (Sam's Club)	33-38	54 DRY	54F - 50/56	45	
Floral	Fresh Cut	Orchids (Walmart)	33-40	54 DRY	54F - 50/56	45	
Floral	Fresh Cut	Pompoms	33-38	34 WET	34F - 32/36	34	
Floral	Fresh Cut	Roses	33-38	34 WET	34F - 32/36	34	
Floral	Fresh Cut	Rose, mini (Walmart/Sam's)	33-40	34 WET	34F - 32/36	34	
Floral	Fresh Cut	Roses, spray	33-38	34 WET	34F - 32/36	34	
Floral	Fresh Cut	Tulips	33-38	34 WET	34F - 32/36	34	
Floral	Bloom Plants	African Violet	40-65	54 DRY	54F - 50/56	55	
Floral	Bloom Plants	Amaryllis	33-40	34 WET	34F - 32/36	34	
Floral	Bloom Plants	Anthurium	50-65	54 DRY	54F - 50/56	55	
Floral	Bloom Plants	Asst color pot	50-65	54 DRY	54F - 50/56	55	
Floral	Bloom Plants	Azalea	38-50	54 DRY	54F - 50/56	55	
Floral	Bloom Plants	Begonia	50-65	54 DRY	54F - 50/56	55	
Floral	Bloom Plants	Cactus, Zygo	50-65	54 DRY	54F - 50/56	55	
Floral	Bloom Plants	Cactus, spring	40-65	54 DRY	54F - 50/56	55	
Floral	Bloom Plants	Cyclamin (Walmart/Sam's)	50-65	54 DRY	54F - 50/56	55	
Floral	Bloom Plants	Cyclamin (Dept 56/Outdoor Living)	50-60	54 DRY	54F - 50/56	55	

Appendix D: Walmart & Sam's Club Temperature Standards for Receiving and Storage of Perishable Commodities

Fresh Area	Category	Commodity	Acceptable Receiving Pulp Temp. Range	Required DC & Trailer Storage Temp (All Sam's 34F Produce - Cold preferred)	DC Storage Setpoint And Alarm Ranges	Suggested Trailer Set Points	Top Ice Pack (GDC Only)
Floral	Bloom Plants	Daffodils	33-40	34 WET	34F - 32/36	34	
Floral	Bloom Plants	Daisy, Gerbera	50-65	54 DRY	54F - 50/56	55	
Floral	Bloom Plants	Gardenia	50-65	54 DRY	54F - 50/56	55	
Floral	Bloom Plants	Hibiscus	50-60	54 DRY	54F - 50/56	50	
Floral	Bloom Plants	Hyacinth	33-38	34 WET	34F - 32/36	34	
Floral	Bloom Plants	Hydrangea	40-55	54 DRY	54F - 50/56	45	
Floral	Bloom Plants	Ivy	40-65	54 DRY	54F - 50/56	54	
Floral	Bloom Plants	Kalanchoe	50-60	54 DRY	54F - 50/56	50	
Floral	Bloom Plants	Keepsake photo box	50-65	54 DRY	54F - 50/56	55	
Floral	Bloom Plants	Lily, Asiatic (Walmart/Sam's)	33-40	34 WET	34F - 32/36	34	
Floral	Bloom Plants	Lily, Calla (Walmart/Sam's)	34-65	54 DRY	54F - 50/56	55	
Floral	Bloom Plants	Lilies (Dept 56/Outdoor Living)	38-48	54 DRY	54F - 50/56	45	
Floral	Bloom Plants	Chrysanthemums	45-65	54 DRY	54F - 50/56	55	
Floral	Bloom Plants	Mums, Pelee	50-65	54 DRY	54F - 50/56	55	
Floral	Bloom Plants	Orchid (Dept 56/Outdoor Living)	50-65	54 DRY	54F - 50/56	55	
Floral	Bloom Plants	Orchid, Cymbidium (Walmart/Sam's)	54-84	54 DRY	54F - 50/56	55	
Floral	Bloom Plants	Rose, mini (Dept 56/Outdoor Living/Sam's)	40-65	54 DRY	54F - 50/56	50	
Floral	Bloom Plants	Sunstar - Orange Star planter	33-40	34 WET	34F - 32/36	34	
Floral	Bloom Plants	Tulips	33-38	34 WET	34F - 32/36	34	
Floral	Bloom Plants	Wishing well	33-40	34 WET	34F - 32/36	34	
Floral	Foliage Plants	18 in. Christmas swan or goose ivy	40-65	54 DRY	54F - 50/56	50	
Floral	Foliage Plants	28 in. ivy tree w/ lights	40-65	54 DRY	54F - 50/56	50	
Floral	Foliage Plants	Bonsai	50-65	54 DRY	54F - 50/56	55	
Floral	Foliage Plants	Cactus/succulents	50-65	54 DRY	54F - 50/56	55	
Floral	Foliage Plants	Christmas trees	33-60	32+	34F - 32/36	34	
Floral	Foliage Plants	Croton cornucopia plant	50-60	54 DRY	54F - 50/56	55	
Floral	Foliage Plants	Eugenia cone	50-65	54 DRY	54F - 50/56	55	

Appendix D: Walmart & Sam's Club Temperature Standards for Receiving and Storage of Perishable Commodities

Fresh Area	Category	Commodity	Acceptable Receiving Pulp Temp. Range	Required DC & Trailer Storage Temp (All Sam's 34F Produce - Cold preferred)	DC Storage Setpoint And Alarm Ranges	Suggested Trailer Set Points	Top Ice Pack (GDC Only)
Floral	Foliage Plants	Ferns	55-75	54 DRY	54F - 50/56	60	
Floral	Foliage Plants	Fresh greenery (wreaths & garland)	0-55	34 DD	34F - 32/36	34	
Floral	Foliage Plants	Holiday Christmas basket ivy	40-65	34 WET	34F - 32/36	50	
Floral	Foliage Plants	Ivy topiary	50-65	34 WET	34F - 32/36	55	
Floral	Foliage Plants	Lucky Bamboo/Silk Orchid	50-65	34 WET	34F - 32/36	55	
Floral	Foliage Plants	Palms	50-65	34 WET	34F - 32/36	55	
Floral	Foliage Plants	Palms, Sago	50-65	54 DRY	54F - 50/56	55	
Floral	Foliage Plants	Pine tree, Norfolk	50-65	54 DRY	54F - 50/56	50	
Floral	Foliage Plants	Pine tree, Stone	50-65	54 DRY	54F - 50/56	55	
Floral	Foliage Plants	Rosemary tree	50-65	54 DRY	54F - 50/56	55	

Appendix E: Previous Updates

These standards have included multiple clarifications of what is **required** and what is **NOT ALLOWED**. These changes have been updated throughout the published standards to provide clarity to Suppliers. The pages have been reorganized to provide a better flow.

PAGE	2023 UPDATES
Changes to Supply Chain Standards	
188-191	Add SQEP Supporting Standards Chart
197-204	Add ISTA Test Standards to General Requirements Section of the Standards, Clarify Requirements
203-206	Clarify Automation Eligible/Ineligible Case Specifications
215	ADD GTIN Use at Walmart page for clarity
217	Clarify ITF-14 Specifications for ability to scan
218	Clarify ITF-14 Specifications for ability to scan
220	Add GS1-128 GTIN barcode guidelines to general case markings
221	Add GS1-128 GTIN barcode guidelines to inner case markings
227	Add GS1-128 GTIN barcode guidelines to Pallet Pull / PDQ Shipping label
238-239	Clarify Additional Unitized Stacking Methods
254	Add Apparel Packaging Standards
265	Add GS1-128 GTIN barcode guidelines to Direct Store Delivery carton markings
266	Clarify GTIN use on Sellable Unit Marking Requirements (FC only)
287	Add GS1-128 GTIN barcode guidelines to Consolidation Center Case Shipping Label
288-289	Add GS1-128 GTIN barcode guidelines to Consolidation Center Pallet Shipping Label
292	Order Unitization Method for Consolidation Center Shipments Added
299	Add GS1-128 GTIN barcode guidelines to inner case markings (Direct Import Items)
310	Add GS1-128 GTIN barcode guidelines to egg case markings
312	Add Scale By Date as to Meat/Poultry required date types
316	Remove ITF-14 as allowable barcode format for Produce Label (PTI label)
318	Add GS1-128 GTIN barcode guidelines to Bakery/Deli Wrap around label
327-332	Update Grocery Consolidation Center Standards
333-357	Update Store Case Marking Requirements for Clarity

Appendix E: Previous Updates, cont...

These standards have included multiple clarifications of what is **required** and what is **NOT ALLOWED**. These changes have been updated throughout the published standards to provide clarity to Suppliers. The pages have been reorganized to provide a better flow.

PAGE	2022 UPDATES
Changes to Supply Chain Standards	
ALL	Update General Standards to Reflect Automation Standards
193	Update Automation Eligible Size Requirements – Add Metric Conversion
202/204	Clarify Items Affecting the Ability to Scan Barcodes
206	Add Chart for Quick Review of General Case Marking Requirements
211-214	Update General Shipping/Pallet Label Requirements
225	Clarify Taping/Adhering of Layer Together or to Additional Layers is NOT ALLOWED
240	Add RFID Shipper Case Marking Requirements
240-246	Update RFID Requirements to Include General Merchandise Categories
268-275	Update Consolidation Center Shipping/Pallet Label Requirements – ACC/MCC and GM Consolidation
301	Clarify Bakery/Deli Labeling Requirements apply to D80 and D98 Only
305-307	FCC (Floral Consolidation Center) Standards Added
308-309	Update GIDC (Grocery Import Consolidation Center) Shipping/Pallet Label Requirements
313-329	Corrected Shipper Case Marking Requirements
342	Clarify Transit Test Flow Chart
343	Add Private Brand General Merchandise ISTA Testing Flow Chart
344	Add ISTA Testing Package Definitions

Appendix E: Previous Updates, cont...

These standards have included multiple clarifications of what is **required** and what is **NOT ALLOWED**. These changes have been updated throughout the published standards to provide clarity to Suppliers. The pages have been reorganized to provide a better flow.

PAGE	2022 UPDATES
Changes to Supply Chain Standards	
188	Update Minimum Recommended Corrugated Specifications
191	Clarify Container Surface Standard
193	Add Shrink Wrap Specific Case Quality Standard 1/27/22 - Clarified 2/4/22
201-202	GS1-128 Barcode Standard Updated
204	Inner Pack Case Markings Standard Added to General Case Markings Section
208-210	Shipping Pallet Label Standard updated, SSCC-18 Barcode changed to required
215	Block Wood Pallet Standards Clarified
216	Tier Sheet Standard Added
219-222	Department 4 Palletization Requirements Updated
223-224	PDQ Display Packout Standard Clarified for Non Standard Pallet Sizes
250-252	WFS (Walmart Fulfillment Services) Standards Added
266-273	Direct Import Standard Updated
283-284	Fresh Egg Standards Added
285-287	Meat/Poultry/Seafood Labeling Standard Clarified, GS1-128 Barcode changed to required
288-290	Produce Labeling/Pallet Standard Clarified, GS1-128 Barcode changed to required
291	Bakery/Deli Case Label Standard Clarified
295-296	GCC (Grocery Consolidation Center) Standard Updated
327	ISTA Testing Chart Clarified
332-340	Receiving Temperature Standards (Appendix D) Updated
343-344	Appendix F: Avery Dennison Labels for Direct Import Shipments Added

Appendix E: Previous Updates, cont...

PAGE	2021 UPDATES
Changes to Supply Chain Standards	
185	SQEP Phase 2 and Phase 3 Defect Description/Definitions Added
202	General Case Markings Updated for Dates, Unprocessed Meats, and Cylindrical Items
210-213	Updated Pallet Standards
218	Update "Palletized Shipments" to "Unitized Shipments"
227	Add Inbound Appointment Scheduling Standard
228	Update TV Test Standards
235-237	Add Direct Store Delivery (DSD) aka Direct To Store (DTS) Standards
239	Update SIOC Standards
240	Add eCommerce Product Specific Requirement Standards
241-244	Add Drop Ship Vendor (DSV) Standards
268	Add Jewelry Distribution Center Standards
269-271	Add Optical Distribution Center Standards
275	Add Goods Not For Resale (GNFR) Standards
277-278	Update Meat/Poultry/Seafood Case and Pallet Label Standards
284	Add HACCP Pallet Placard for GCC Shipments
311-312	Add Frozen Seafood Carton Marking Requirements
Appendix D	Update Receiving Pulp Temperature Range

Appendix E: Previous Updates, cont...

PAGE	2021 UPDATES
Changes to Supply Chain Standards	
-	Integration of eCommerce Packaging, Labeling, and Testing Standards
183	SQEP Rollout Dates and PO Accuracy Chart Updated
201	Clarify Domestic Shipping Label Requirement for Grocery Distribution
203	Update WERCS Guidance and contact information
204	Remove ORM-D / IATA Reference
205	Add eCommerce Pallet Label Requirement
206	Add Grocery Pallet Label Requirement
209	Stretch wrap NOT ALLOWED to cover slip sheet flaps
210	Clarify 85" is the maximum height when shipping a full pallet pull
222	Clarify loose cases are NOT ALLOWED on top of pallets
245	Update Lithium-ion Airfreight Case Marking Requirements
259	Add Meat/Poultry/Seafood Case Labels
263	Add Automated Grocery Distribution Center Requirements
264	Update GIDC Pallet Requirement
-	Update to General Merchandise Case Markings (icons and dept. #)
Appendix C	Updated ISTA Test Overview and Guidance
Appendix D	Updated Inbound Temperature Guidelines
Appendix E	Add Previous Updates

Appendix E: Previous Updates, cont...

PAGE	2020 UPDATES
Changes to Supply Chain Standards	
	E-commerce Requirements Removed (See E-commerce specific publication on Retail Link)
185	Added Supplier Quality Excellence Program (SQEP)
189, 230	Minimum Conveyable Dimensions Updated to 5" L x 3.5" W x 2" H
189, 194, 213	Black Corrugated and Black Plastic Film change from Avoid to Not Allowed
189	Edge Casters/Wheels Not Allowed for Conveyable Cartons
189, 191, 201	Minimum shrink wrap tray height reduced to 2" for items other than glass (glass product requirement remains at 3" minimum height)
194, 223	Apparel and Shoes require UPC-A on outside of polybags or shrinkwrap
195-196	Updated size/print standards for GTIN
197-198	Add: GS1-128 Barcode Standards
205	Updated pallet standards, including instruction for oversized pallets
207	Updated Slip Sheet Standards
208, 211, 215	Updated perishable pallet heights from 84" to 96"
211	Gluing or taping layers or cartons together is not allowed
210	Added Size Requirements for Tier Sheets
213	Updated Stretch Wrap Requirements
219	Updated ASN standards
221	Updated TV Packaging Standards
222	Glass product testing requirements updated
224-227	Add: RFID Standards for Apparel
228-235	Add: DSDC Standards
236-240	Add: Consolidation Centers Standards
246	Add: Slip sheet Standards for Import DC
251-253	Add: RX Network Standards
254	Add: Grocery Consolidation Temperature Guidelines
258	Add: Grocery Import DC Standards
259-260	Add: Grocery Consolidation Standards

Appendix F: Walmart USA and Puerto Rico Case Labels

Ordering Avery Dennison (AD) Labels

- Supplier requests labels by completing and faxing or emailing the call-out form to the appropriate AD office at least ten (10) days before the PO cancel date. AD will transmit the order to the appropriate production site.
- Complete all **required** data fields.
 - DATE SUPPLIER SENDS CALL-OUT FORM** (Date the Supplier transmits the order)
 - REQUESTED LABEL DELIVERY DATE** (Date desired for delivery of labels from AD. Allow for normal transit times so that labels arrive when **required**.)
 - SHIP TO** (Where to deliver labels - details, accurate address, contact name, phone, and fax)
 - BILL TO** (To whom bill will be sent - details, accurate address, contact person, phone, and fax)
 - ORDER FOR** (Check appropriate Walmart retail market.)
 - WALMART PO #** (Enter 10 digits, including any leading zeros.)
 - WALMART ASSORTMENT #** or **ITEM #** (Enter assortment number if both numbers [assortment and item] exist in Walmart PO; otherwise, enter item number.)
AD is not authorized to change the Walmart item number. If the item number entered on the call-out form is different than the item number on the PO, AD will work with the Supplier and Walmart for resolution.
 - ACTUAL SUPPLIER STOCK #** (Enter Supplier's actual stock number, even if different from stock number in Walmart PO. Enter only one stock number per item or assortment. For assortments, enter only the stock number assigned to the assortment.)
 - NUMBER OF LABELS REQUIRED** (Indicate desired allowance quantity [including any overage or safety stock] for each Walmart PO. AD will not print any additional quantities.)
- Transmit call-out form to a location listed in the call-out form. Do not send the call-out form more than 4 weeks before the requested label delivery date. Contact local AD service representatives to obtain order status.
- AD electronically cross-references the call-out with the Walmart PO within 24 hours. If exceptions exist, AD researches the problem with an expectation of resolution within 48 hours.

- AD advises the Supplier if they cannot confirm the call-out within 24 hours. AD periodically advises the Supplier (and Walmart if it is a critical issue) of the status of specific types of suspended orders until resolved, confirmed, or canceled. AD notifies the origin cargo manager (OCM) only if the PO number declared by the Supplier does not match AD's file of Walmart POs.
- A confirmed call-out initiates printing of the labels.
- AD normally ships labels within 72 hours (3 working days) after receiving a confirmed call-out. If AD receives the call-out well before the 72-hour production window (in other words, if the form arrives early), AD immediately prints the labels and holds until time to deliver according to the requested label delivery date. AD relies on the accuracy of the addresses on the call-out and ships labels to the exact address provided in the call-out. Likewise, AD sends the invoices to the "Bill to" address specified on the call-out.



NOTE - For eCommerce only: When the vendor case quantity is equal to 1, meaning one selling unit is within its own shipping case, a UPC-A (GTIN12) or EAN (EAN-13) formatted barcode is required on the outer case.

Print Locations, Pricing, and Freight Charges

Avery Dennison label call-out form, label prices*, locations, and contacts, can be found on Walmart Retail Link at: [Docs > Global Direct Importing Information > Packaging, Shipping, & Pallet Requirements - Avery Dennison Direct Import Shipping Case Barcode Label Call-Out Form](#)

*Prices are from FCA Avery Dennison's production facility, which adds delivery charges to the invoice. Complete the call-out form and fax or email it to the appropriate AD ticketing center.

Appendix F: Walmart USA and Puerto Rico Case Labels, cont...

Delayed Direct Imports Shipping Labels

Occasionally a late PO creation or revision will delay transmission of a PO. If AD reports that a label is delayed due to not receiving the electronic PO, ask the AD office to request the PO from Walmart. Often, by the time Walmart receives the request, AD will already have received the PO. If, after another day, the AD office still does not have the PO in their system, refer to the Contacts section of this manual for the appropriate contact.

Invoicing for Direct Imports Shipping Labels

Supplier pays the cost of the labels, including delivery charges. Suppliers who have no credit history with AD should contact AD for a credit application. Complete the application and fax it to the appropriate AD office prior to or with a first call-out. AD bills the Supplier semi-monthly. Terms for payment are net 30 days from the invoice date. Keep the account current.

Application of Direct Imports Shipping Labels

The Supplier applies case labels before delivering cargo to the port. The label has the same format and shows the same type of information as the label shown on the right. This process also applies to replenishment orders.

Direct Imports Shipping Label Inspections

The Supplier applies the labels before a scheduled quality inspection, if applicable. Inspectors check that the Supplier applies labels in the proper location and that contents match both case markings and labels. Failure to comply results in a failed inspection. The Supplier corrects label errors and pays any and all incurred charges. Upon issuance of the shipping order or Supplier declaration, the OCM confirms whether the Supplier applied the labels.

If the Supplier delivers cargo to an OCM warehouse for consolidation, the OCM inspects shipping case labels. If the OCM identifies problems, the OCM immediately contacts the Supplier to coordinate and solicit authorization for corrective action.

Suppliers are accountable for any and all changes to labels on cases.

Replacement Direct Imports Shipping Labels - Supplier Error

If the Supplier does not properly apply case labels prior to shipment, or if labels are missing upon arrival at PO destination, Walmart can file a claim against the Supplier for replacement labels, which are printed by deconsolidator or Walmart Import distribution center (DC) and applied at destination. The fee is US \$1.00 per case.

NOTE - If Supplier already paid for incorrect labels, AD issues a credit note to the Supplier so that the Supplier pays only once for correct labels.

Replacement Direct Imports Shipping Labels - Walmart Error

When sending a revised call-out to AD, the Supplier sends a separate explanation of reason(s) for label reorder to WGS or DSG, as appropriate, with copy to OCM and Walmart contact, if available.

Upon receipt of a revised call-out, AD prints and delivers the new labels. If updated PO information is not available to AD, they will ask Walmart for confirmation. AD does not delay processing and delivery of new labels while awaiting confirmation.

If confirmed, AD issues 2 bills:

- The Supplier pays only the charges for the correct labels.
- Walmart pays the previous charges for the incorrect label.

	
PO#	6100096916
	
00000020746162	
TO: US	000002
DEPT 00010	←
PO 6100096916	←
ITEM 002074616	←
SUPPLIER STK	12345678912345678912

Case label (example only)

Case GTIN in ITF-14 format

DEPT # 5 digits (counting leading zeros)

PO # 10 digits (counting leading zeros)

ITEM # shown on the barcode label will be the 9-digit assortment number (counting leading zeros) if both the assortment number and item number exist on the purchase order; otherwise, the ITEM # shown on the barcode label will be the individual item number.

TO: US	000002
DEPT 00010	APPAREL
PO 6100096916	
ITEM 002074616	
SUPPLIER STK	12345678912345678912

If the order is for an apparel or related department, the word **APPAREL** will appear in white text against a black background.



Secondary Packaging

FAQs and Glossary

August 10, 2023

General FAQs

Q: Do cases shipping into a Grocery DC need to be automation eligible?

A: Cases are likely to encounter conveyance and automation within the grocery DCs. Consult with the Logistics Packaging Manager at logpkg@wal-mart.com.

Q: Can I ship on slip sheets instead of pallets?

A: If your load weighs out before it cubes out, you must ship on pallets. Suppliers must contact the Logistics Packaging Manager at logpkg@wal-mart.com for approval before shipping on slip sheets.

Q: Does Walmart require a specific brand of pallet such as Chep or Peco?

A: Walmart does not endorse any specific brand of pallet. Pallets must meet or exceed the minimum pallet standards found in the Supply Chain Standards.

Q: My item does not fit on a standard 48" x 40" pallet. Can I ship on an oversized pallet?

A: The shipping case should be designed to fit within a standard 48" x 40" pallet footprint. If the dimensions of the item exceed the footprint of a standard pallet, contact the Logistics Packaging Manager at logpkg@wal-mart.com.

Q: Is a GS1 BOL required?

A: A GS1 standard BOL is preferred when shipping into a Walmart DC.

Q: Can I master pack or consolidate vendor packs in one shipping case to save on freight costs?

A: No. Walmart DCs receive by the vendor pack. You should only ship in the vendor pack size set up by the buyer. Walmart cannot guarantee proper receipt when items are master packed. Exceptions may be made in the Walmart.com environment.

Q: Can I band multiple vendor packs together when shipping UPS or FedEx?

A: No. Multiple vendor packs cannot be banded together. This is considered master packing and may cause receiving errors.

Q: Can I ship multiple items on the same pallet?

A: Yes. Items from the same PO can be loaded on the same pallet. You should also load the trailer by PO by item. Freight should be layered by item and not spread throughout the pallet.

Q: Is a GTIN barcode still required when sending ASNs?

A: Yes. The GTIN barcode identifies the shipping case. The GTIN barcode is one of many **required** data fields on each vendor pack that has more than one selling unit in the case. See the General Case Markings section of these standards for more information.

Q: Do I have to have a shipping label on each case?

A: Yes, unless you're shipping unitized pallets to the DC in full truckload quantity. In that instance, a pallet label is acceptable. See the Supply Chain Standards more information.

Q: Can I put all the required markings and shipping information on one label?

A: Yes. Your product identification information can be included on the shipping label. The label must be on each case when using only one label.

Q: My vendor pack does not meet the minimum automation eligible case requirements. Should I increase the dimensions of my case to meet the automation eligible case requirements?

A: No. You should not add unnecessary packaging to your case. If your item does not meet the minimum automation eligible requirements found in the Supply Chain Standards, work with your buyer to

increase the case pack size or set the item up as a break pack.

Q: How often does Walmart update its packaging standards?

A: The secondary packaging standards are typically reviewed and updated every 6 months. It is the Supplier's responsibility to understand and comply with the packaging standards. An executive summary is included in each revision to allow for a quick review of standards changes.

Q: What is Walmart's GS1 Prefix?

A: Walmart's GS1 Prefix is 78742.

Plastic Bag Safety Labeling FAQs

Q: How is the 5" opening measured?

A: Per Rhode Island's law, the 5" opening is the diameter of the opening.

Q: Is the 40" ("greater than 40", this warning or an equivalent warning must repeat at 20" intervals") actually supposed to be surface area?

A: No, this was a typo. Per Massachusetts law, "In the case of bags whose total length and width (when added) is more than 40", the label shall be repeated at 20" intervals."

Q: What is the timeline for making changes if the verbiage on my bag does not match verbatim?

A: The verbiage need not match verbatim. The warning must be present as outlined or something approved as equivalent thereof. If your existing warning is not equivalent to the outlined requirement, do a rolling change to come into compliance as soon as possible.

Q: Does the warning need to be in Spanish?

A: No, this warning need not be bilingual.

Q: Can this warning be in multiple languages?

A: English is the only language **required**; however, if you choose to include additional languages, that is acceptable.

Q: On font size chart, is the bag size length x width or length + width?

A: The bag size for the purpose of finding the correct font should be calculated by adding the length and width (length + width).

Q: My bag is .6 mm thick. Do I need the warning?

A: No. The warning is **required** if the bag is less than one mil (0.001 inch or 1/1000 of an inch) which in metrics is equivalent to 0.0254 mm. If your bag is more than 0.0254 mm, the warning is not required.

Q: If the plastic bag's thickness is more than one mil (0.001 inch), then NO need to print warning on bags?

A: Correct. If the bag is thicker than one mil (1/1000 inch, 0.001 inch, 0.0254 mm), then no warning is required.

Q: Does the warning need to be printed on both sides of the bag?

A: The warning must be "visible" on both sides of the bag. Therefore, if the plastic is clear and the warning can be viewed from both sides, it need not be printed on both sides. If the bag is a solid color, the warning must be printed on both sides in contrasting color.

Q: How big does the bag have to be to have the warning?

A: If the bag is less than one mil thick and has an opening of 5" in diameter and is of sufficient size to hold the warning in 10 point font, the warning must appear. There is no "minimum" size bag for this warning.

Questions or comments:

Suppliers may submit questions or comments by emailing them to gmcomply@walmart.com.

Glossary

Aged Inventory

Items that have been in DC inventory for 90 days or longer.

Assembly

A method by which stores replenish basic merchandise. Normally, replenishment is reviewed once each week. The stores and quantities are consolidated by warehouse, and a Type 33 purchase order is generated automatically by the system and sent to the Supplier.

Backhaul

Process where merchandise is transported from a vendor to a DC via Walmart truck.

Bill Of Lading (BOL)

Document received and sent with merchandise to prove acceptance of goods for shipping and/or receiving.

Break Pack

A case received in the warehouse with two or more inner selling units that can be broken down and shipped to the stores.

Carrier Due Date (CDD)

The date generated at load level by the Walmart Transportation Department to set carrier delivery expectations. It will not necessarily match up with the MABD.

Carrier Pickup Date (CPU)

The date provided after the PO has run through the LoadBuilder optimization system. As a result of this optimization, there are times when the CPU is different from the original ship on date. The Supplier should follow the CPU, not the ship on date.

Case Pack

Merchandise shipped in full cases. Cases cannot be broken into smaller cases.

Claim

Action taken against a carrier, Supplier, or individual for lost and/or damaged freight.

Consolidation Facility (Center Point)

A central location that processes full trailer loads of LTL-sized POs. The POs are cross docked and reloaded on outbound trailers destined to Walmart and Sam's Club DCs.

Consolidator

A point where Walmart freight is accumulated, consolidated, and forwarded to the distribution center.

Corporate Traffic

The department responsible for contracting carriers, carrier claims, freight payment, and collect shipments.

Cross Docking

Process of less than truck load (LTL) Suppliers consolidating their loads with other Suppliers. This merchandise is then delivered to the warehouse, where it is split based on store number to be shipped to. This is also referred to as distribution receiving.

Cube

The amount of space an item of merchandise occupies.

DC Pooling

A type of two-tier where product need for multiple DCs, fulfilled from the same Supplier ship point, is evaluated. A truckload order is generated and routed to a specified consolidation facility when the need for the multiple DCs rises to the level that a full truckload can be ordered.

Dangerous Goods

Solids, liquids, or gases that can harm people, other living organisms, property, or the environment. They are always subject to chemical regulations.

Direct to Store (DTS)

Merchandise that travels directly from the vendor to a retail store. For questions or issues with DTS shipments, reach out to your SSM.

Direct Store Delivery Consolidation (DSDC)

A program developed to provide an efficient channel to replenish stores in less-than-case pack quantities.

Display Ready Container (DRC)

Open top carton made from corrugated material. Widely used to move produce items throughout the supply chain.

Drop

A location where a trailer stops to load/unload merchandise.

Drop and Hook

An empty trailer is dropped at a Supplier or warehouse and a loaded trailer is picked up.

Glossary

EPCIS

(Electronic Product Code Information Services) is a global GS1 Standard for creating and sharing visibility event data, both within and across enterprises, to enable users to gain a shared view of physical or digital objects within a relevant business context.

Free on Board or Freight on Board (FOB domestic)

The point at which the ownership of merchandise passes from the seller to the purchaser. Indicates that the seller provides transportation from the factory to trucks, railcars or consolidators, after which point the buyer assumes responsibility for ownership and associated shipping costs.

Global Location Numbers (GLN)

Also referred to as EAN location codes, ANA numbers, ILN numbers. A 13-digit number that identifies a trade location or company.

Global Trade Item Number (GTIN)

A globally unique number used to identify trade items, products, or services. GS1 defines trade items as products or services that are priced, ordered, or invoiced at any point in the supply chain.

International Air Transportation Association (IATA)

Trade association for the world's airlines. Works closely with local governments to develop regulations for hazardous materials or dangerous goods.

International Maritime Dangerous Goods (IMDG)

International guideline to the safe transportation or shipment of dangerous goods or hazardous materials by water on vessel.

International Safe Transit Association (ISTA)

The organization that sets the standard for safe packaging and safe transit within specified damage limits. Walmart packaging must meet specific ISTA standards for strength and durability.

Import Distribution Center (IDC)

A facility designated to hold import merchandise until a particular selling season. The facilities are located across the nation.

Imports

Merchandise brought in from another country.

Item Number

A 9-digit number assigned to an item of merchandise. This is the Walmart identification number for the items carried in the store and throughout the replenishment system.

Lead Time (LT)

The number of days between order creation and the date the product is available to ship to stores.

Less than Truckload (LTL)

A PO which is too small to be economically transported by itself on a truck, but rather is combined with other POs for transportation.

Manifest

List of all materials included in a shipment, provided by seller.

Master Case

Several cases being shipped in one package. These can be broken down into the individual cases and sent to stores.

Master Pack

A case that contains more than one vendor pack or shipping unit inside it.

Minimum/Maximum

The minimum constraint that must be met for a vendor to ship product. The maximum constraint legally fitting on a truck for the vendor to ship the truck.

Must Arrive by Date (MABD)

The date by which a PO must be received at the warehouse. This is equal to the Must Deliver By Date.

National Motor Freight Classification (NMFC)

A freight classification system designed to establish fair measures and standardize freight pricing. Shippers and carriers use these classifications when determining shipping rates.

Out of Stock (DC)

When available inventory at the DC cannot support the pulls from the stores, the DC will show an out of stock condition to indicate the lack of inventory.

Outside Storage

A facility, other than the main picking warehouse, used to hold merchandise.

Overage

An amount of inventory stock that exceeds the inventory expected.

Overflow

The process whereby a trailer to be shipped is filled before all of the merchandise has been loaded. The remaining merchandise is loaded on another trailer.

Pallet

A movable platform used to stack cases or boxes. Also called a skid. There are two main types of pallet: stringer pallets and block pallets. Stringer pallets are the most commonly used with Walmart shipments.

Pallet Pull

An item that is shipped to stores where the entire pallet is considered one case.

Glossary

Pick Slot or Prime Slot

The location in the DC from which product is selected for store orders.

Planned Ship Date (used only with TAB POs)

The ready date on the load that the Supplier can see on the CLT under the Planned Ship Date column. This date is only a suggestion for any load going directly to a Walmart DC.

Product Displayed Quickly (PDQ)

A corrugated display (pallet or tray) used to hold multiple pieces of merchandise for quick stocking and restocking of the sales floor. It may also contain a space for marketing descriptions and price impressions to aid in the customer's understanding of the value of the product on display.

Purchase Order (PO)

A document issued by Walmart to Suppliers indicating the details of an approved purchase (product, quantity, size, color, etc.).

Purchase Order (PO) Type

A 2-digit code that describes the type of PO being written. This code makes up the third and fourth digits of the PO number.

Purchase Order Validation Template (PVT)

The PVT is an Excel document that will contain the following PO information: event code for the POs, PO number, item number, item description, replenishment contact, department number, DC number, case count the PO was written for, total number of POs for that event, totals for all PO case counts, and MABD for the event.

Request for Routing (RFR)

The system used to enter and track all Walmart and Sam's Club POs as the associated shipments move through the warehouse distribution system to the final destination.

Return Center

A central collection point that processes defective merchandise returned from the stores, consolidates defective merchandise for return to the Suppliers, and issues credits to stores for returned goods.

Return to Vendor

Merchandise returned to vendor from the DC per instructions from the buyer or group managers. Usually returned due to overages, wrong items, or wrong warehouse pack, etc. These problems are identified at the time of receiving.

Reusable Plastic Container (RPC)

Multiple-use containers constructed of durable plastic. Used to protect goods as they move through the supply chain.

Rotate Date

For a frozen item, the rotate date is the date the product is received at the warehouse. For a perishable item, this is the sell by date of the item.

Ship On Date

The date that is specified by RFR at the time of PO entry. POs must be keyed into RFR in Walmart Retail Link by 4 p.m. CT and within 24 hours of receiving the PO.

Shortage

When less than the amount of freight noted on the freight bill arrives at the distribution center.

Slot

A rack where pallets of merchandise are stored in a DC. Each slot has a number associated with it.

Solid Fiber

Also referred to as "Paperboard", is a thick paper based material. Solid Fiber is generally thicker than paper and can be single or multi-ply. Solid Fiber materials used for slip/tier sheets are designed to be stronger and more moisture resistant than corrugated packaging.

Staple Stock

Merchandise stocked in the warehouse on a regular basis (type 20 and 50 items).

TAB

Short for Tabular, meaning circular ad merchandise or freight. Product that is being shipped for a specific advertised event.

TI/HI (also called Pallet Pattern)

TI refers to the number of cases that make up a tier or layer on a pallet. HI refers to the number of tiers or layers on the pallet. A pallet holding five cases of an item on a layer, stacked four high has a TI/HI of 20.

Traffic

The Walmart department responsible for routing merchandise to the DCs. Also an area within the DC that processes inbound trailers.

Trailer Manifest

A document produced by the DC traffic department that shows what is on every trailer that enters the DC trailer lot.

Unitized

A method of bundling multiple case packs together to be moved as a single unit through any portion of the supply chain. Usually achieved via palletization or the use of slip sheets.

Vendor Pack

Original packaged quantity or merchandise as shipped from the vendor.

Voluntary Inter-Industry Commerce Standard (VICS)

An EDI and BOL standard primarily used by the retail industry. Walmart supports this standard.

Zero-Based Mindset

A zero-based mindset means starting from scratch and building up to what your costs should be, based on the outcomes you want. This is a modern alternative to the practice of examining past results and incrementally carving out costs.

Glossary

- **ASN:** **Advanced Shipment Notice.** EDI document sent by Supplier detailing quantities shipped on a PO prior to merchandise arrival.
 - **DC:** **Distribution Center.** Short for Walmart's Distribution Centers.
 - **DSD:** **Direct Store Delivery** (aka DTS or Direct to Store). Supplier ships direct to the store location, bypassing Distribution Centers.
 - **DSDC:** **Direct Store Delivery Consolidation.** Uniquely packed, store-specific cases cross-docked through the RDCs.
 - **DSV:** **Drop Ship Vendor.** Suppliers ship directly to customer or site-to-store, bypassing the Walmart Distribution Centers.
 - **GEM:** **Global Enterprise Mailbox.** Multipurpose tool for AS2 communication setup, mailbox maintenance, and document testing.
 - **GNFR:** **Goods Not For Resale.** Items shipped to Walmart that are not meant for sale to customers, including signage, fixtures, etc.
 - **GLN:** **Global Location Number.** A numerical value used to identify a specific location (Stores/DCs).
 - **OMS:** **Order Management System.** A tool with various functionalities used to support order generation and maintenance.
 - **PFS:** **Pay From Scan.** Product is shipped to Walmart and payment is made after the merchandise is sold at the stores.
 - **POS:** **Point of Sale Inventory.** An inventory order originated by a Walmart store and sent to a Supplier for fulfillment. Replenishment uses Store level on hands and forecasted sales to generate an order for a store.
 - **RDC:** **Regional Distribution Center.** Walmart has several RDCs which process freight in full pallet quantities, individual automation eligible and automation ineligible case quantities, and break pack quantities.
 - **UOM:** **Unit of Measurement.** Defines how items are shown on orders as either single selling units or cases. Single selling units refers to the total number of selling units and cases refers to the total number of warehouse packs ordered by the stores.
 - **WFS:** **Walmart Fulfillment Services.** Sellers ship product to Walmart for fulfillment when a customer places an order.
 - **VMI:** **Vendor Managed Inventory.** An inventory order originated by a Supplier or other vendor to fulfill inventory in a Walmart store.
 - **SRR:** **Shortage Recovery Rate.** A calculation that represents shortages of items that were sent on the ASN but were not physically present on the audit.
 - **EDI:** **Electronic Data Interchange.** This is the electronic communication of information between businesses, i.e., Walmart and Suppliers.
- EDI Documentation:**
- **EDI 850:** **Purchase Order.** Used to place an order for goods or services. It generally provides the same information found on a paper Purchase Order (PO), including items, prices, quantities, and shipping details.
 - **EDI 856:** **Advance Ship Notice or Advanced Shipment Notification.** Often abbreviated to ASN, this is an electronic notification of a pending delivery, similar to a packing list.
 - **EDI 824:** **ASN Errors.** EDI document sent to detail errors from an ASN. This document is automatically generated and sent to DSDC Suppliers to inform them when their ASN is rejected.
 - **EDI 997:** **Functional Acknowledgment.** This serves as a response, or electronic receipt, between EDI transactions. It's an alert that tells the sender that the receiver has accepted the EDI data. When a Supplier sends Walmart an ASN, Walmart sends back an EDI 997 to acknowledge receipt of the document. This document also alerts Suppliers that their EDI 856 ASN was rejected and provides a reason for the rejection.
 - **EDI 810:** **Invoice.** This is the electronic version of a paper invoice. It is sent in response to an EDI 850 Purchase Order as a request for payment once the goods have shipped or services are provided.
 - **EDI 864:** **Text Message.** This is a text message sent to detail errors on the EDI 810.